

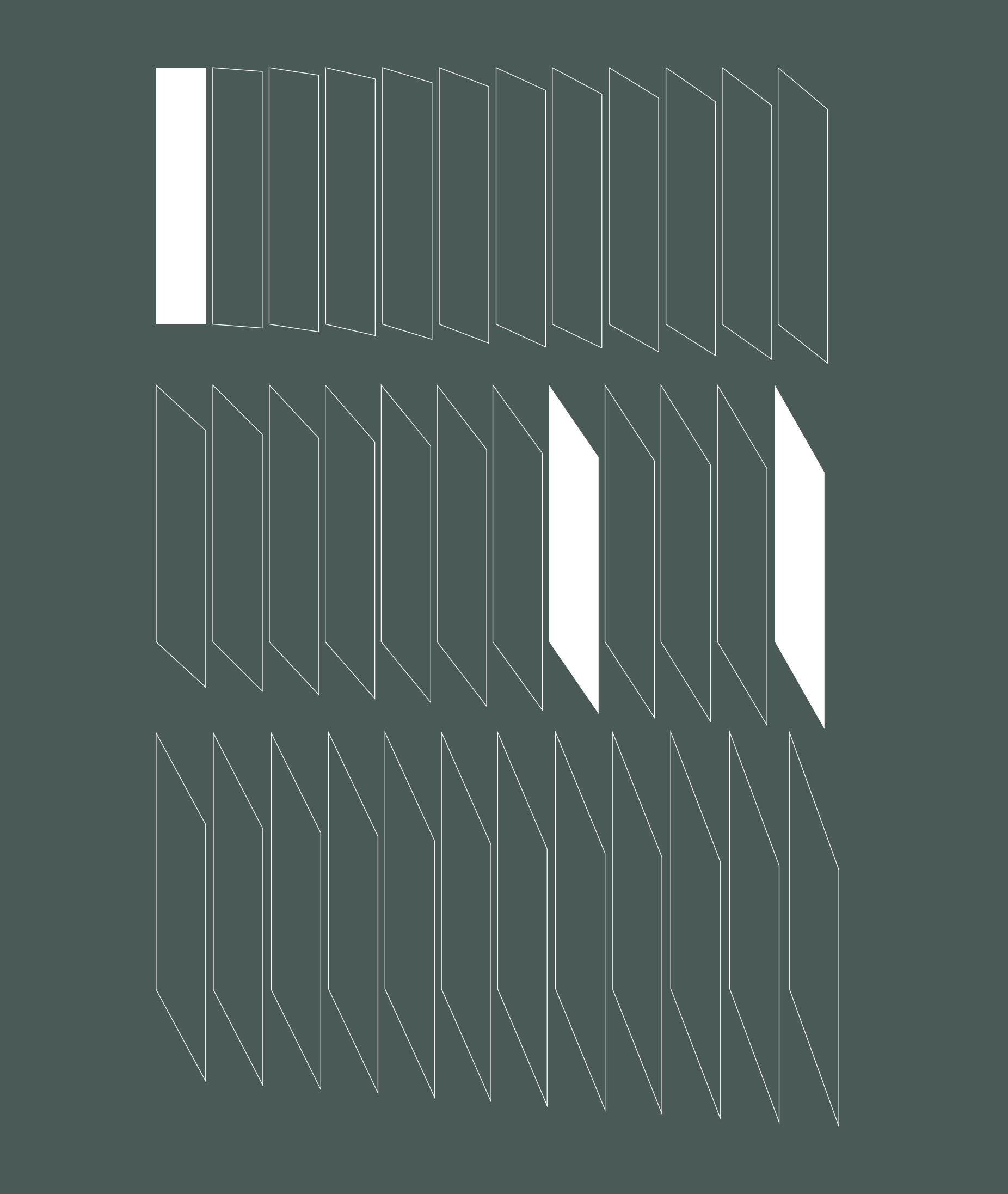

Doors & Partitions 2021



PARETI / PARTITIONS*Design by Piero Lissoni*01_ Sherazade Wall
*p.9*02_ Sherazade Wall Patchwork
*p.43*03_ Aladin Wall Mono
*p.57*04_ Aladin Wall Duo
*p.73***PORTE / DOORS***Design by Piero Lissoni*05_ Sherazade Spin
*p.105*06_ Sherazade Spin Patchwork
*p.115*07_ Aladin Spin Duo
*p.127*17_ Sherazade Double Swing Plain
*p.243*18_ Sherazade Double Swing
Slim Jambs Patchwork
*p.251*19_ Sherazade Swing Frame
*p.259*08_ Sherazade Slide
*p.137*09_ Sherazade Slide Patchwork
*p.151*10_ Aladin Slide Mono
*p.171*20_ Aladin Swing Plain Mono
*p.263*21_ Aladin Double Swing Plain Mono
*p.273*22_ Aladin Swing Plain Duo
*p.283*11_ Aladin Slide Duo
*p.185*12_ Sherazade Pocket
*p.195*13_ Aladin Pocket Duo
*p.205*23_ Aladin Swing Frame Duo
*p.305*24_ Aladin Pivot Plain Mono
*p.311*25_ Disegni Tecnici + Finiture
*p.321*14_ Aladin Pocket Frame Mono
*p.215*15_ Sherazade Swing Plain
*p.221*16_ Sherazade Swing
Plain Patchwork
p.235





PARETI / PARTITIONS





Finitura pannello: Cristalli trasparenti colorati –
116. grigio caldo / 117. arancio rosato / 118. cedro
Finitura alluminio: 314. anodizzato dark brown S
Maniglia senza supporto

Panel finish: Transparent coloured glass –
116. grigio caldo / 117. arancio rosato / 118. cedro
Aluminium finish: 314. anodized dark brown S
Handle without support









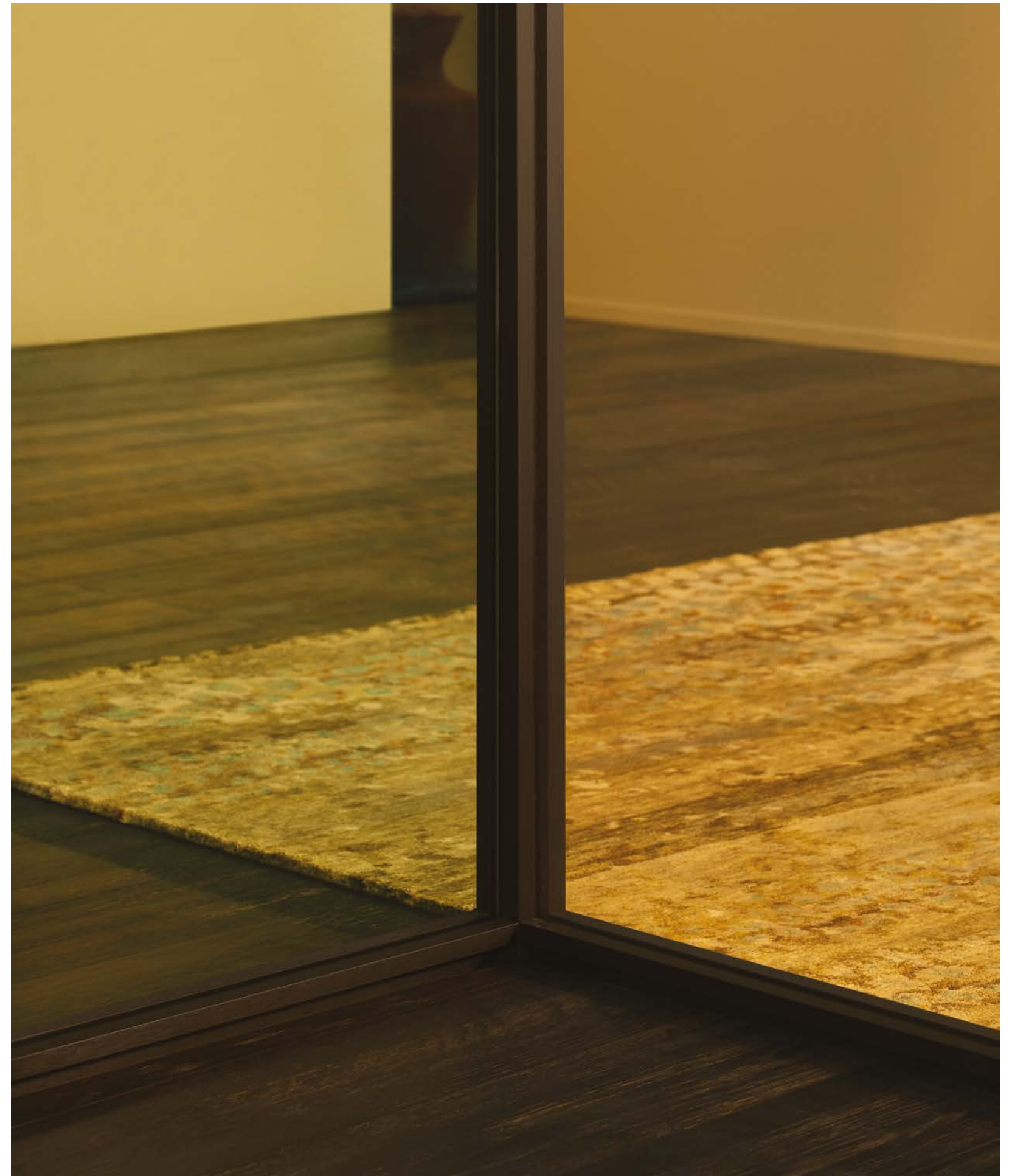



Finitura pannello: Cristalli extralight con tessuti – 550. giotto
Finitura alluminio: 313. anodizzato bronzo S
 Maniglia senza supporto

Panel finish: Extralight glass with fabrics – 550. giotto
Aluminium finish: 313. anodized bronzo S
 Handle without support













Finitura pannello: Cristalli flutes trasparenti colorati - 209. grigio caldo
Finitura alluminio: 314. anodizzato dark brown S
 Maniglia con nottolino

Panel finish: Flutes transparent coloured glass - 209. grigio caldo
Aluminium finish: 314. anodized dark brown S
 Handle with revolving plug







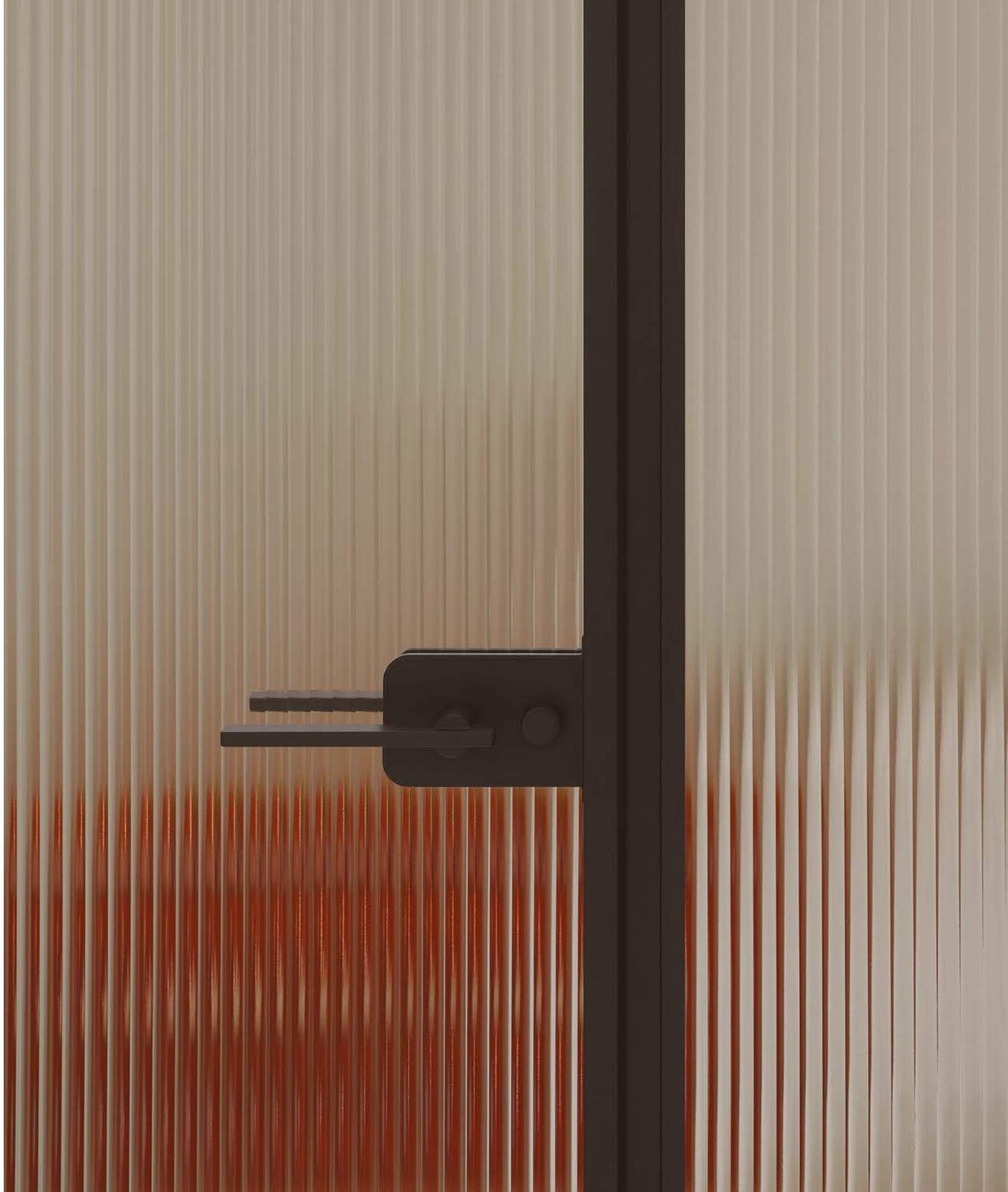



Finitura pannello: Cristalli stampati trasparenti – 520. flutes
Finitura alluminio: 300. verniciato bianco RAL 9016
Modulo tecnico / Maniglia con serratura elettrica

Panel finish: Transparent patterned glass – 520. flutes
Aluminium finish: 300. painted white RAL 9016
Technical module / Handle with electric lock









Finitura pannello: Cristalli stampati trasparenti
Finitura alluminio: 301. verniciato nero RAL 9005
 Maniglia senza blocco

Panel finish: Transparent patterned glass
Aluminium finish: 301. painted black RAL 9005
 Handle without block









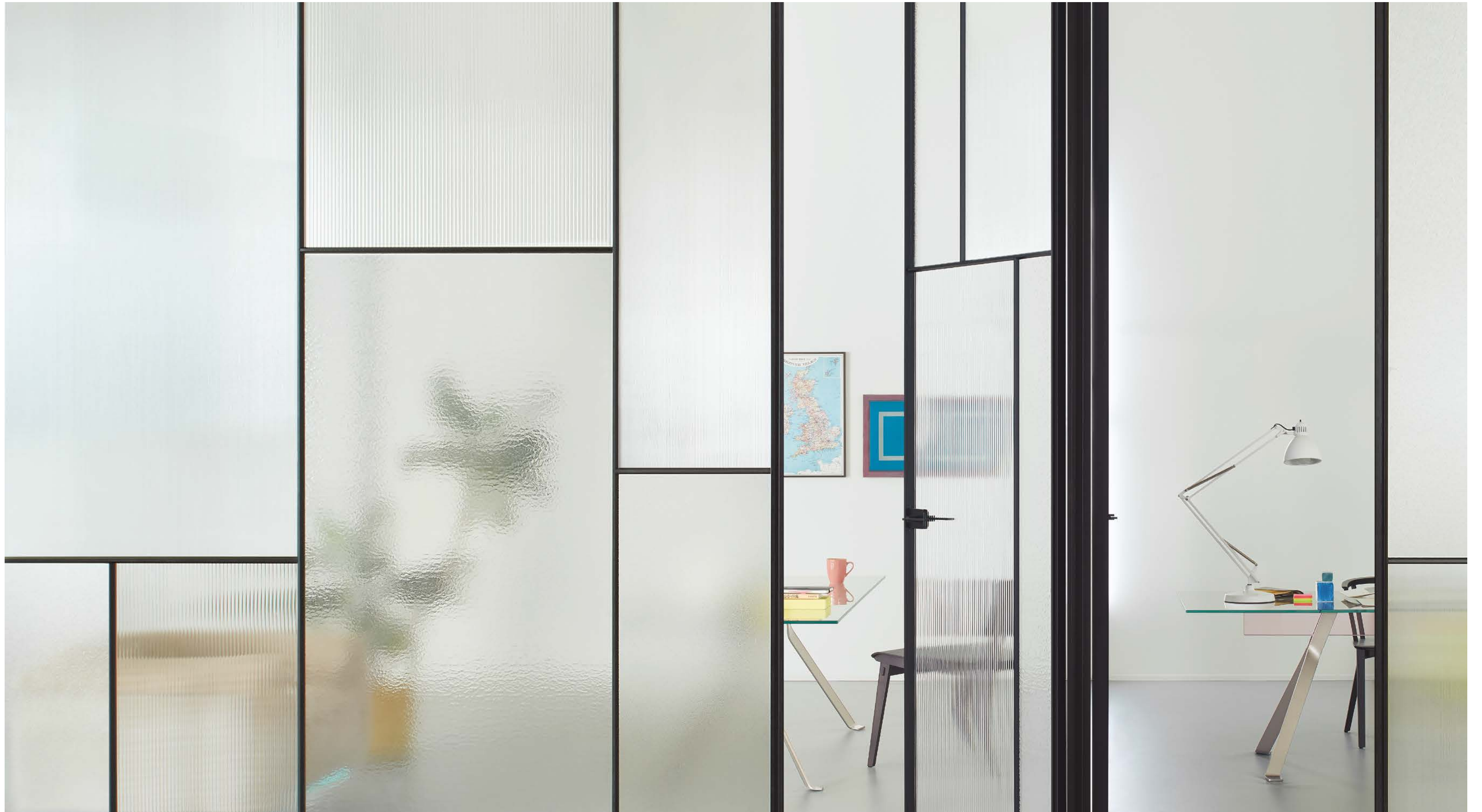







Finitura pannello: Cristalli extralight con tessuti - 552. masaccio
Finitura alluminio: 314. anodizzato dark brown S
 Maniglia ovale senza supporto

Panel finish: Extralight glass with fabrics - 552. masaccio
Aluminium finish: 314. anodized dark brown S
 Oval handle without support





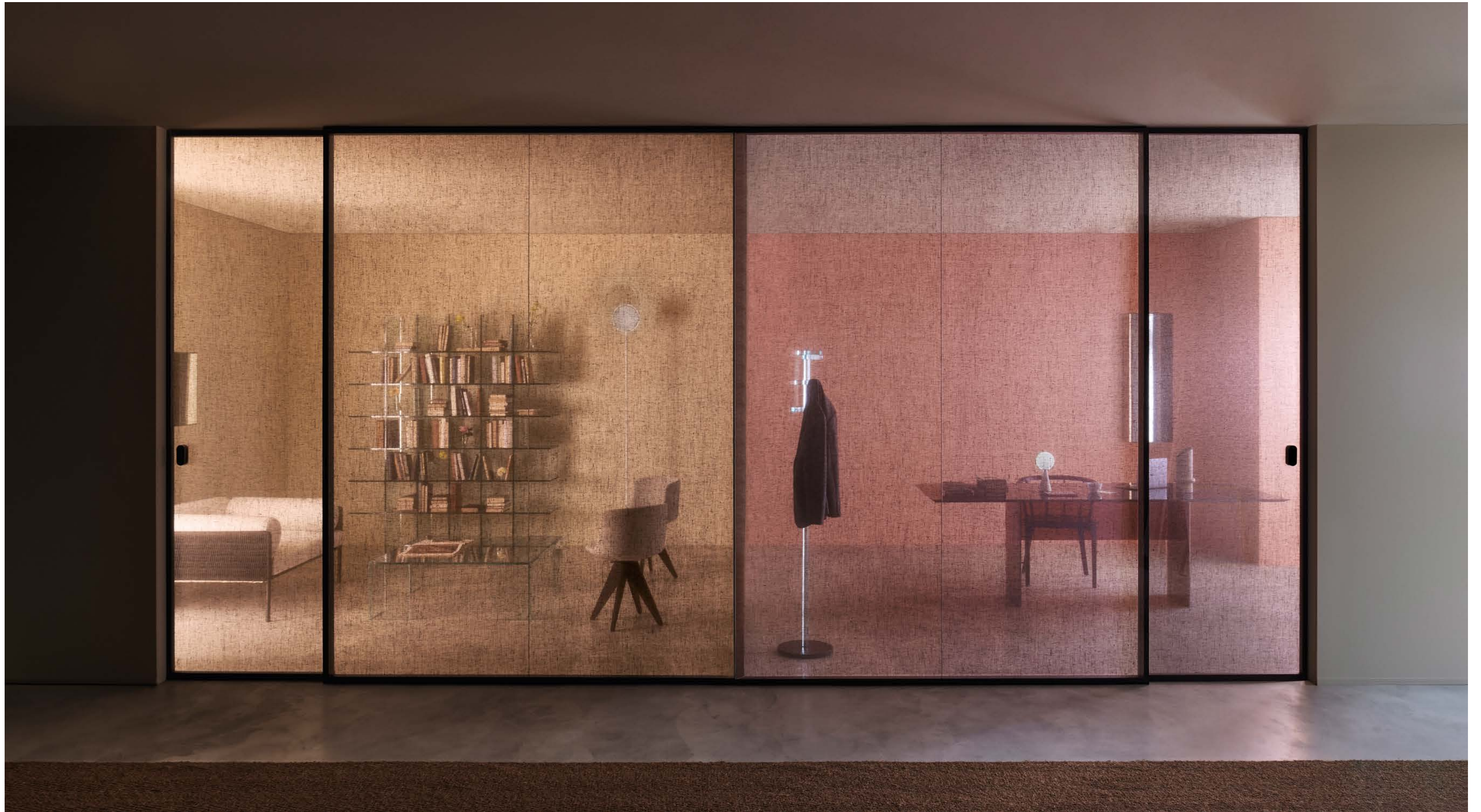

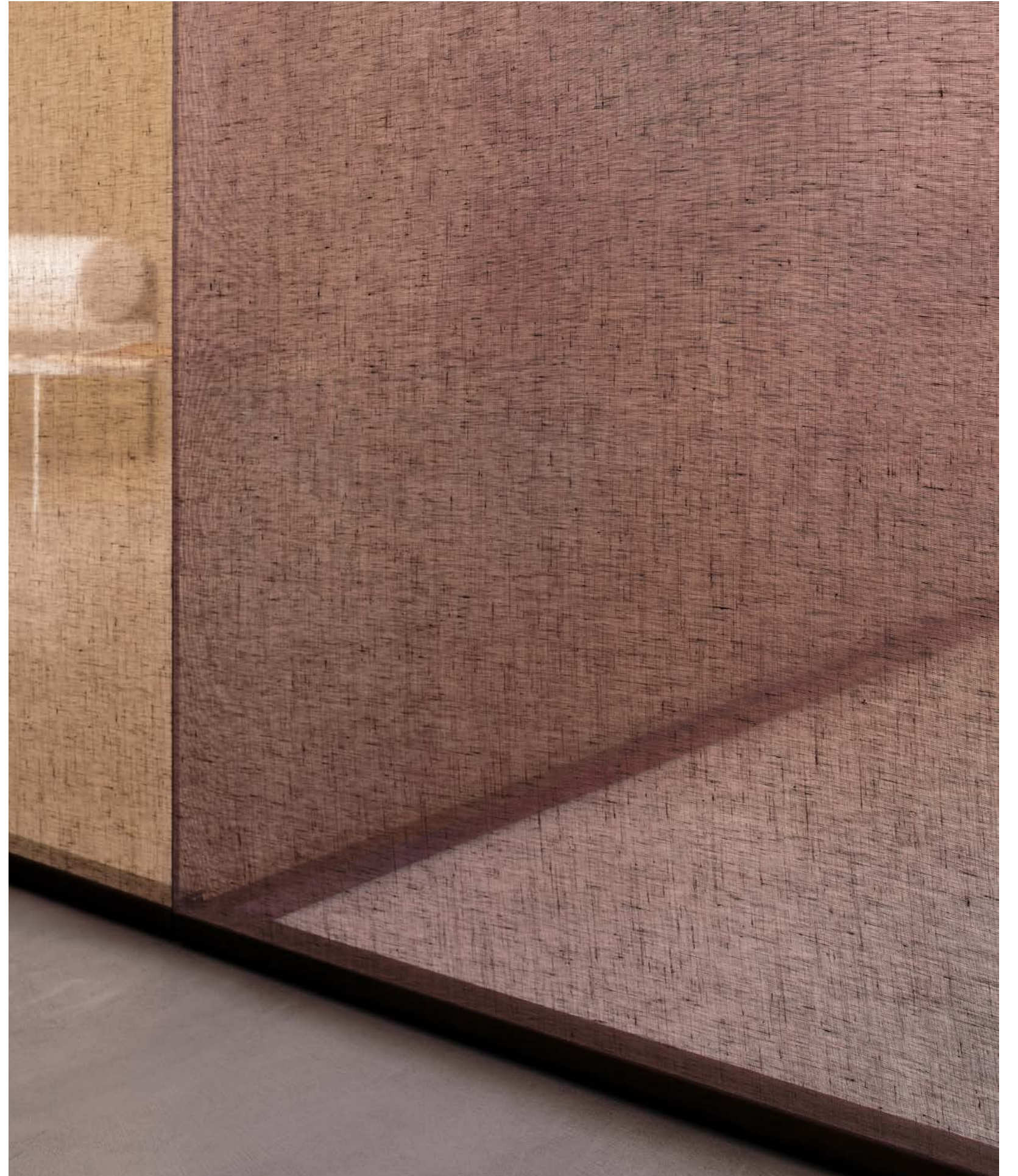
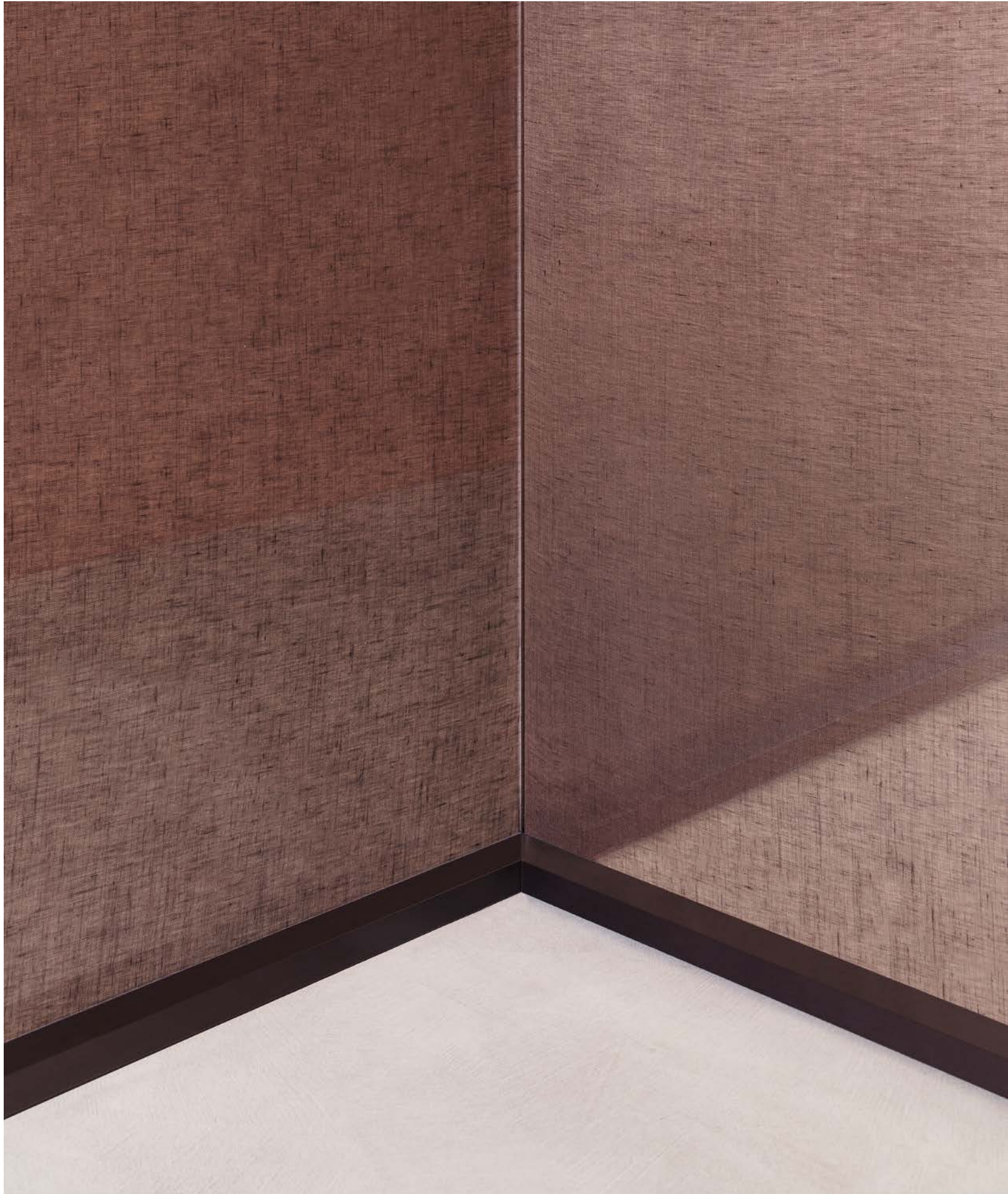

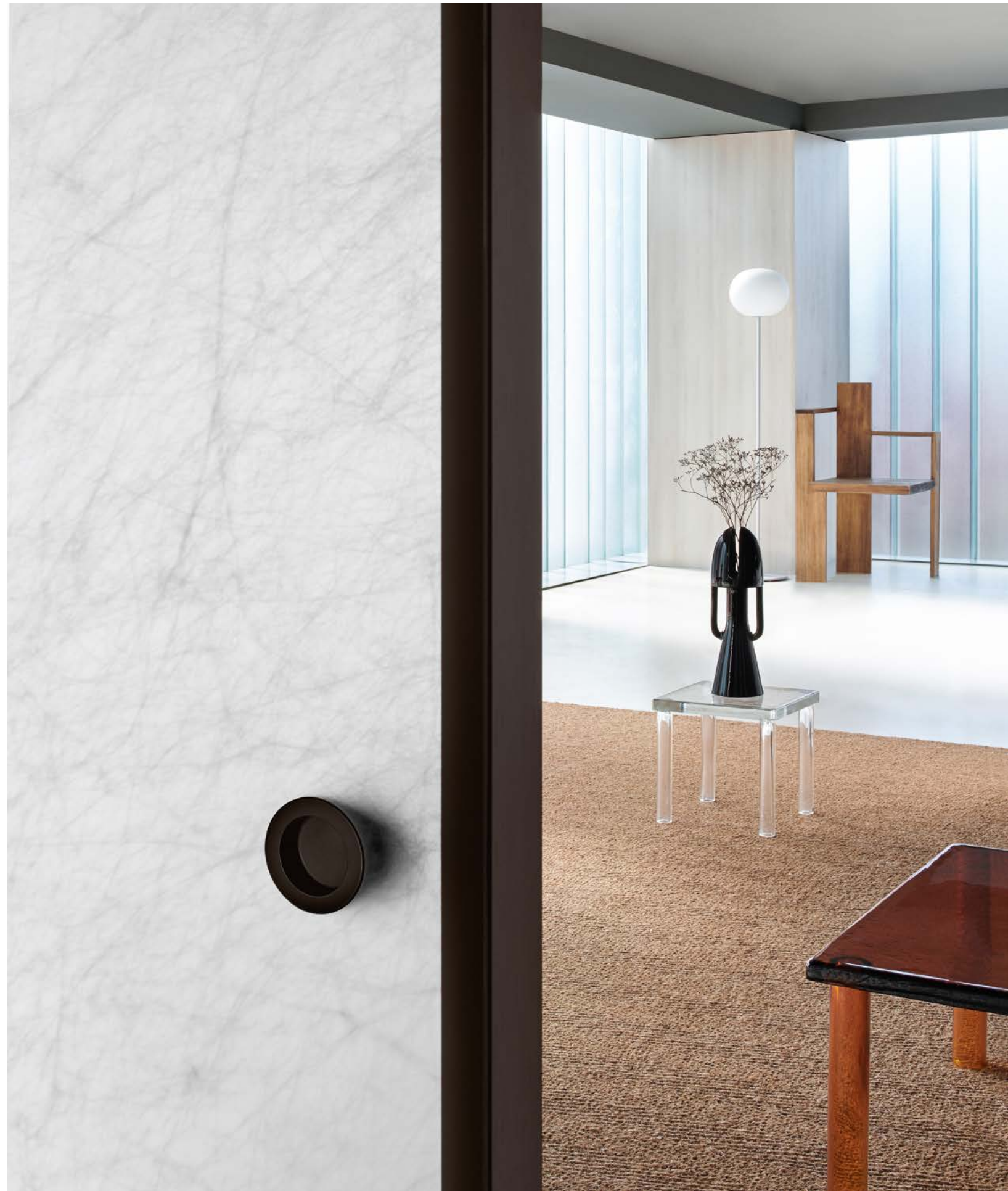

Finitura pannello: Cristalli extralight con tessuti - 555. carta di riso opaca
Finitura alluminio: 314. anodizzato dark brown S
 Maniglia tonda senza supporto

Panel finish: Extralight glass with fabrics - 555. carta di riso opaca
Aluminium finish: 314. anodized dark brown S
 Round handle without support











Finitura pannello: Cristalli riflettenti trasparenti - 504. riflettente chiaro
Finitura alluminio: 315. anodizzato inox S
 Maniglia con chiusura privacy



Panel finish: Reflecting transparent glass - 504. riflettente chiaro
Aluminium finish: 315. anodized inox S
 Handle with privacy lock









Finitura pannello: Cristalli stampati trasparenti - 520. flutes
Finitura alluminio: 314. anodizzato dark brown S
 Maniglia senza blocco



Panel finish: Transparent patterned glass - 520. flutes
Aluminium finish: 314. anodized dark brown S
 Handle without block













Finitura pannello: Cristalli trasparenti neutri – 500. extralight
Finitura alluminio: 301. verniciato nero RAL 9005
Modulo tecnico / Pomolo con serratura elettrica



Panel finish: Neutral transparent glass – 500. extralight
Aluminium finish: 301. painted black RAL 9005
Technical module / Knob with electric lock

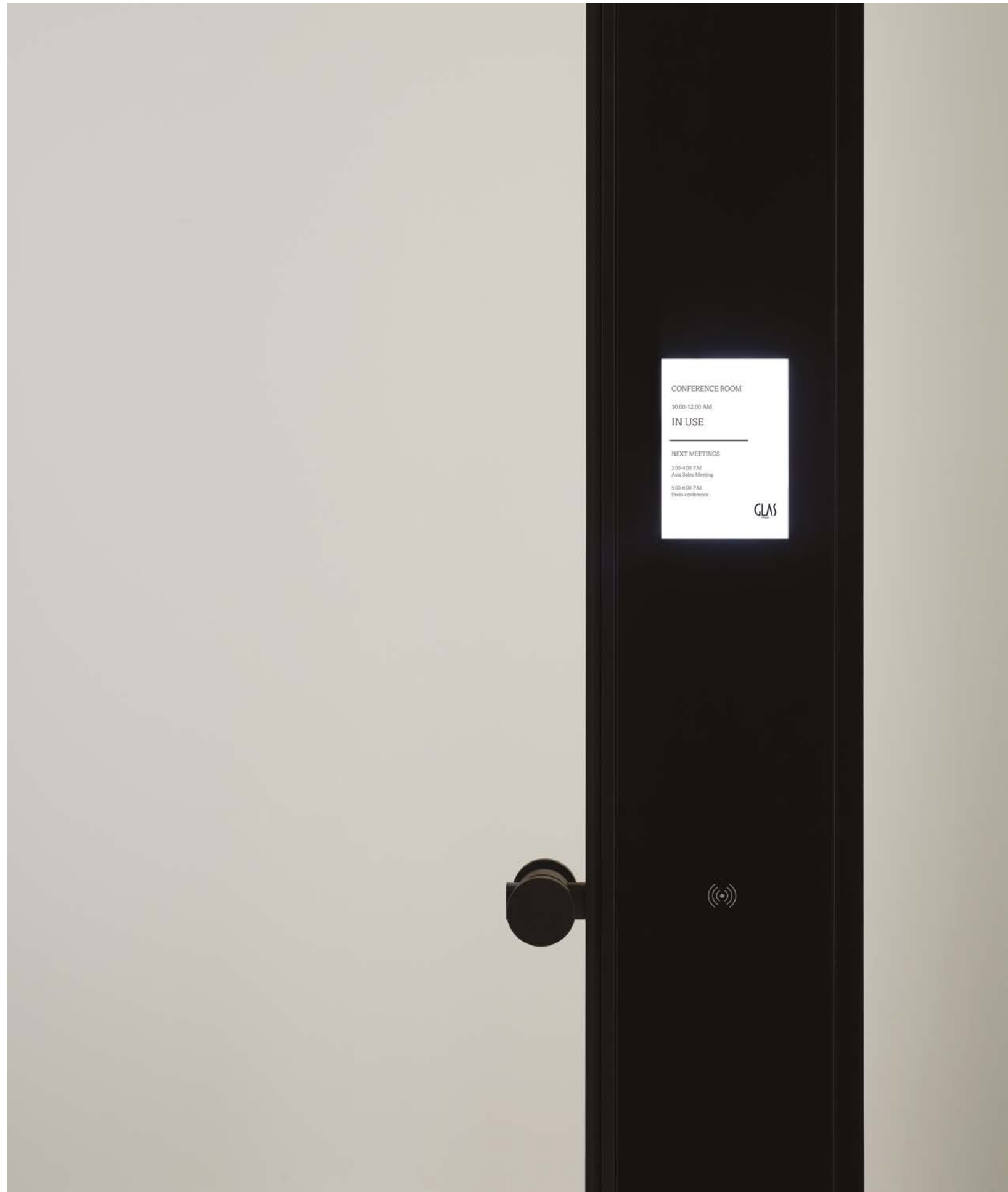



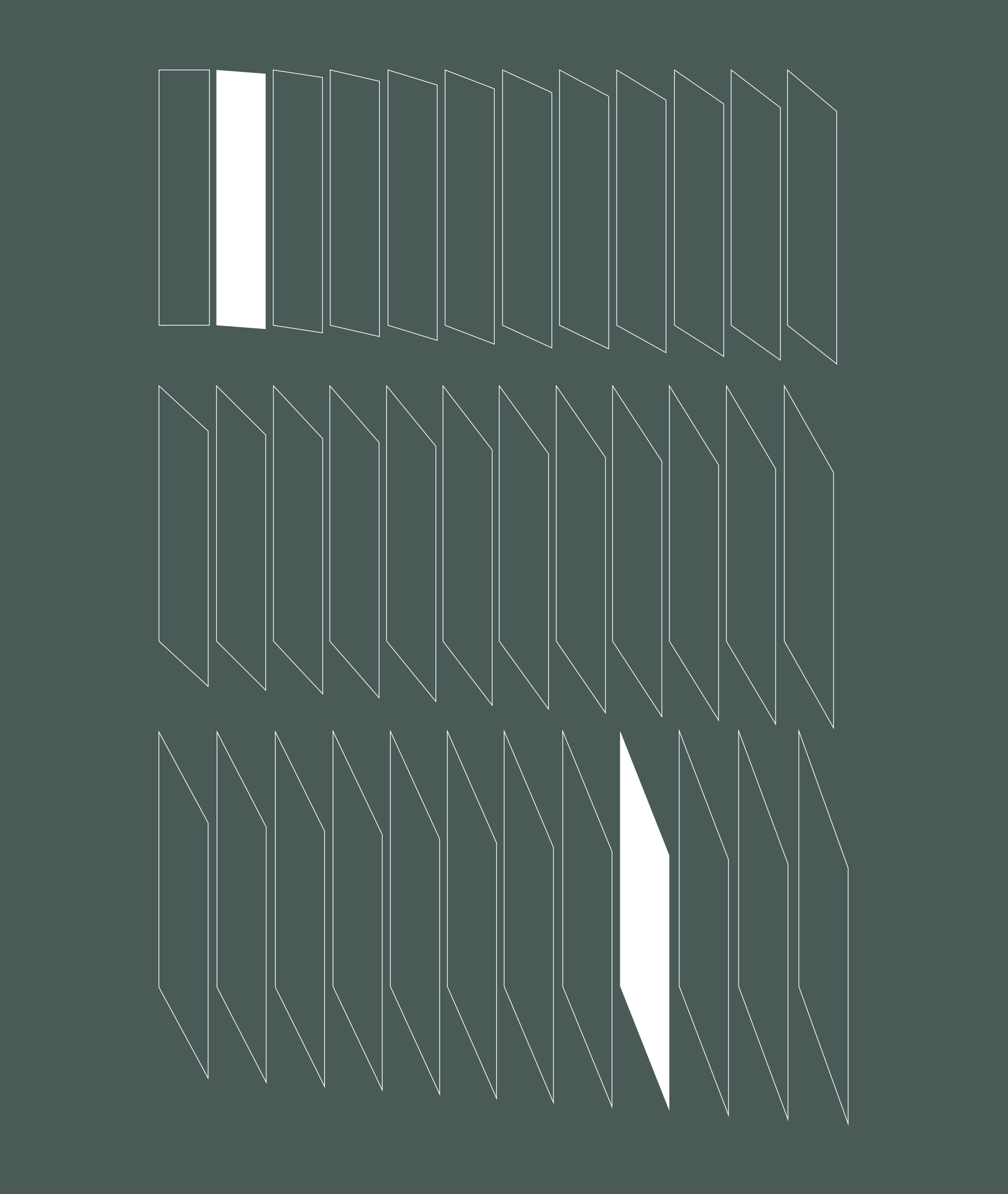



PORTE / DOORS



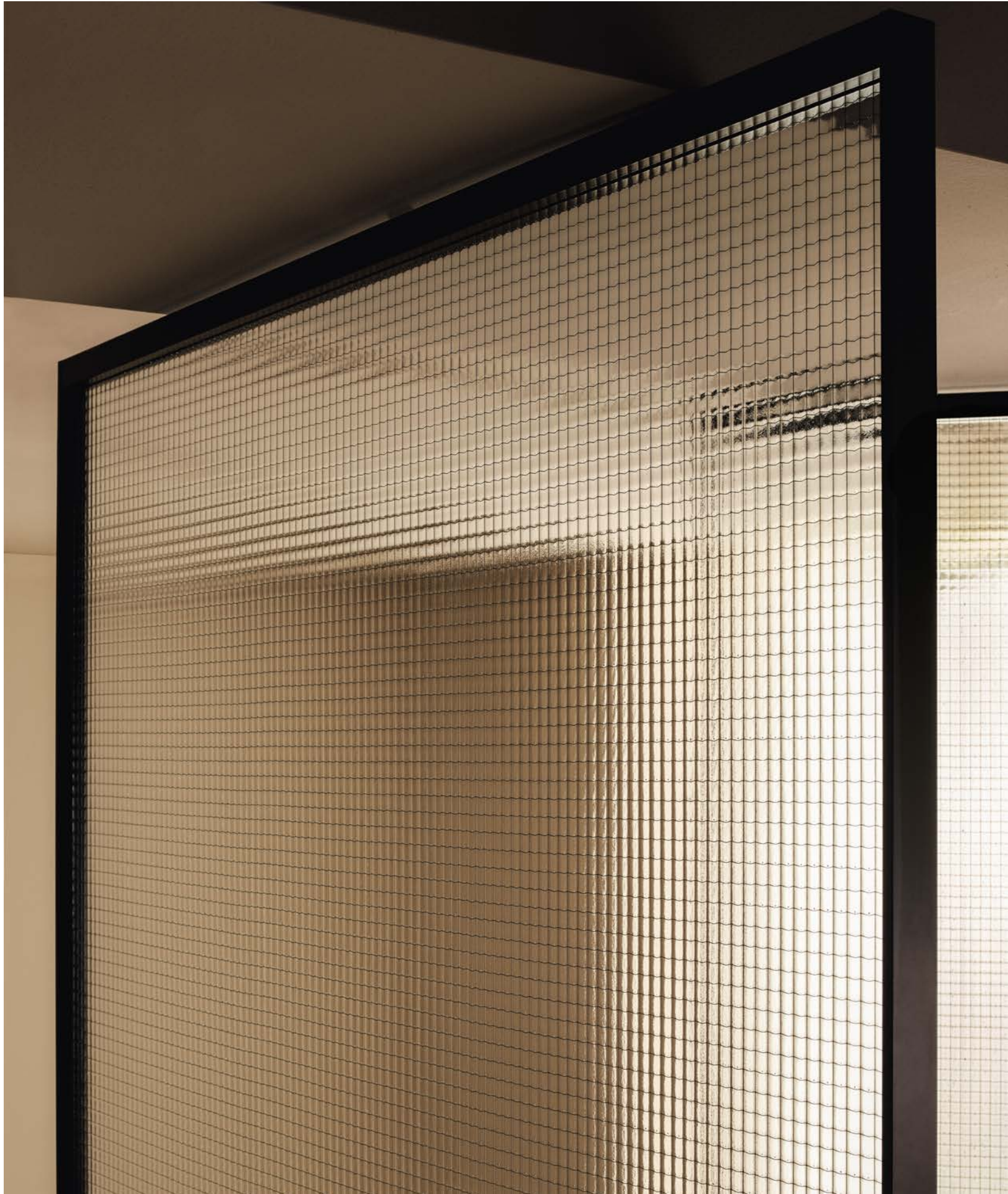

Finitura pannello: Cristalli stampati trasparenti - 533. retinato
Finitura alluminio: 301. verniciato nero RAL9005
 Maniglia senza supporto



Panel finish: Transparent patterned glass - 533. retinato
Aluminium finish: 301. painted black RAL9005
 Handle without support

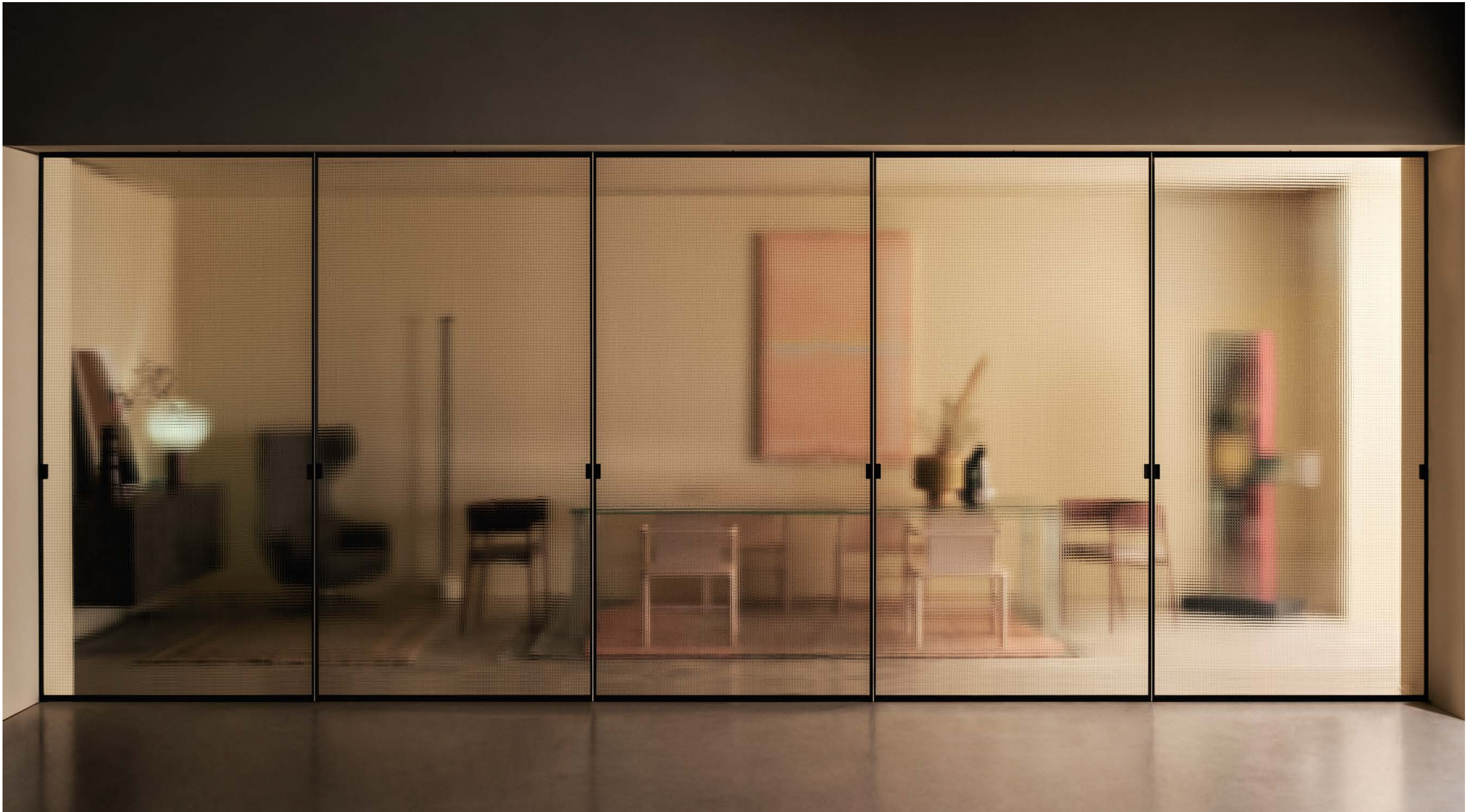









Finitura pannello: Cristalli extralight con tessuti – 553. botticelli
Finitura alluminio: 300. verniciato bianco RAL 9016
 Maniglia senza supporto



Panel finish: Extralight glass with fabrics – 553. botticelli
Aluminium finish: 300. painted white RAL 9016
 Handle without support













Finitura pannello: Cristalli acidati monofacciali - 601. acidato monofacciale fumé

Finitura alluminio: 300. verniciato bianco RAL9016

Maniglia tonda senza supporto

Panel finish: Single faced acid-etched glass - 601. acidato monofacciale fumé

Aluminium finish: 300. painted white RAL9016

Round handle without support





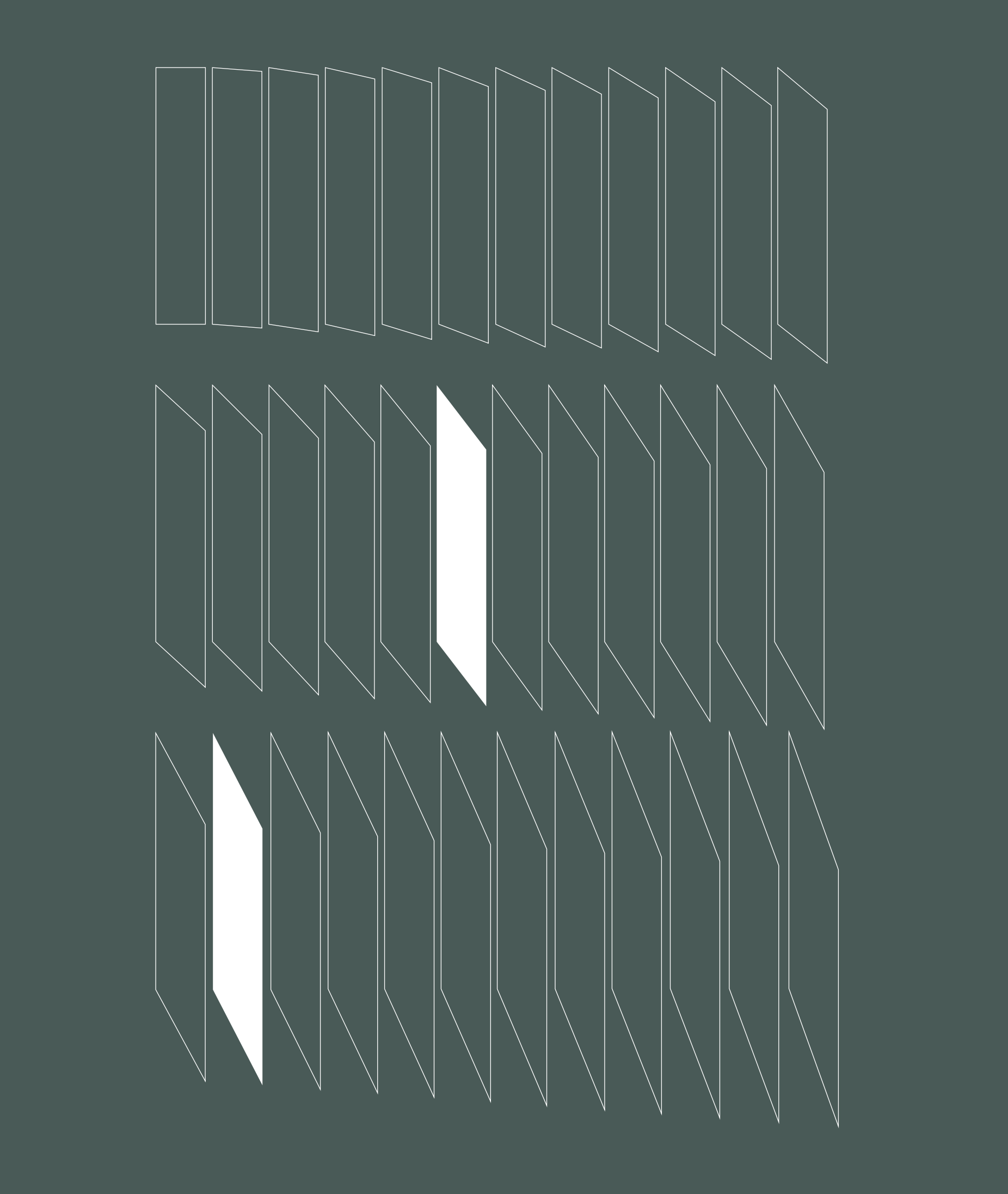







Finitura pannello: Cristalli extralight con reti - 531. wide bronze
Finitura alluminio: 313. anodizzato bronzo S
Maniglia senza supporto



Panel finish: Extralight glass with meshes - 531. wide bronze
Aluminium finish: 313. anodized bronze S
Handle without support





Finitura pannello: Cristalli riflettenti trasparenti - 504. riflettente chiaro
Finitura alluminio: 314. anodizzato dark brown S
Maniglia senza supporto



Panel finish: Reflecting transparent glass - 504. riflettente chiaro
Aluminium finish: 314. anodized dark brown S
Handle without support

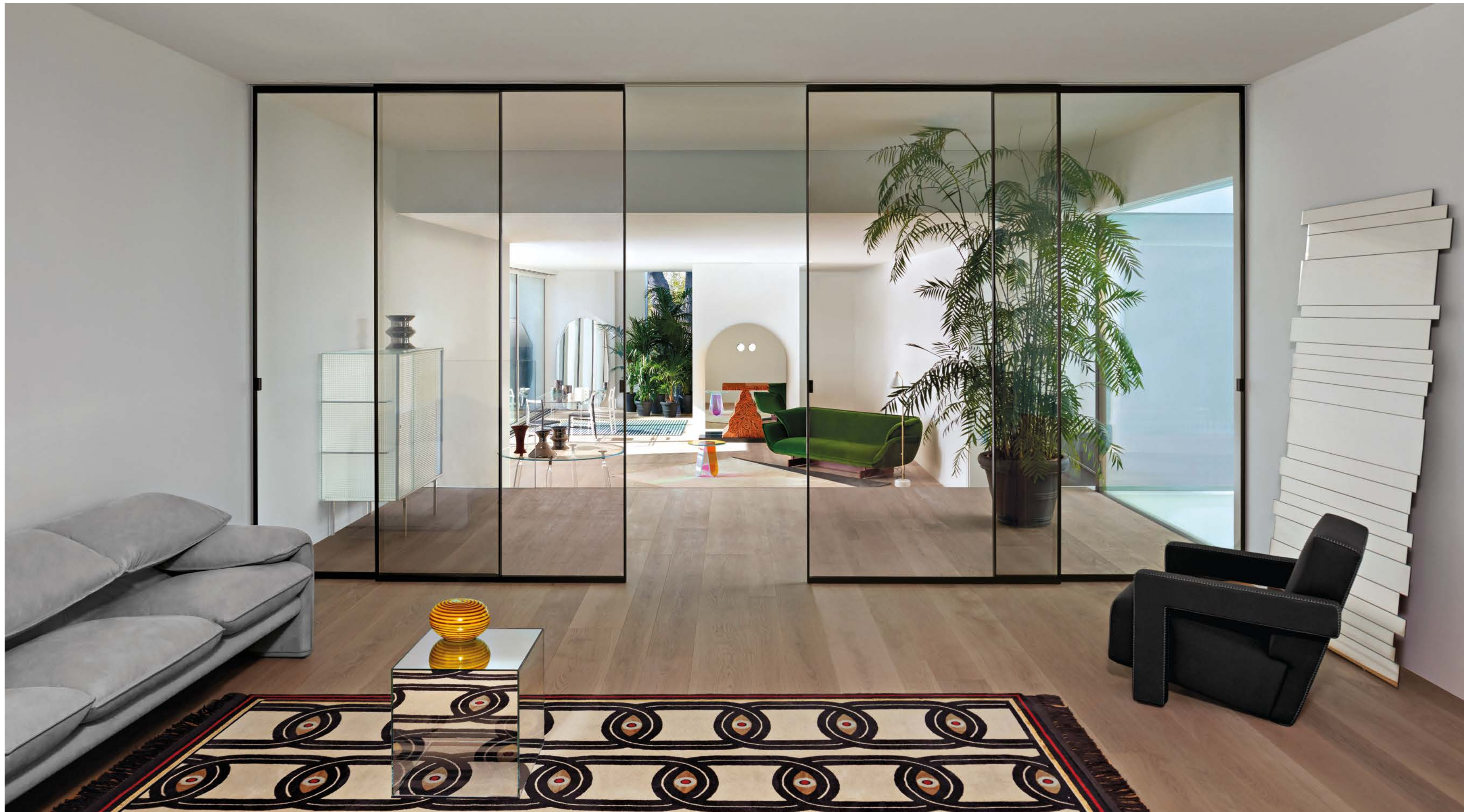

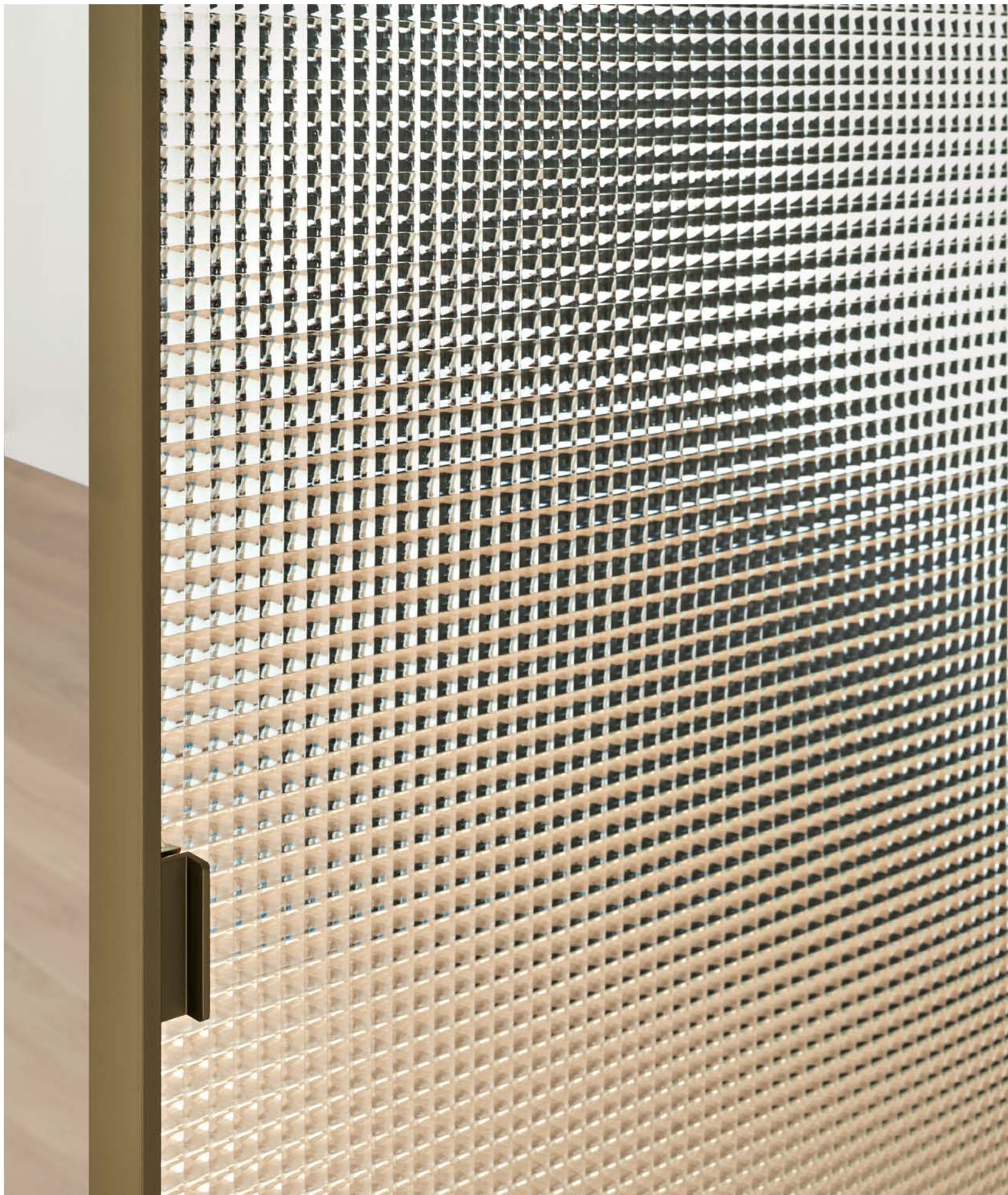

Finitura pannello: Cristalli stampati trasparenti - 523. quadretti
Finitura alluminio: 313. anodizzato bronzo S
 Maniglia senza supporto



Panel finish: Transparent patterned glass - 523. quadretti
Aluminium finish: 313. anodized bronze S
 Handle without support







Finitura pannello: Cristalli trasparenti colorati
Finitura alluminio: 301. verniciato nero RAL9005
Maniglia senza supporto

Panel finish: Transparent coloured glass
Aluminium finish: 301. painted black RAL9005
Handle without support









Finitura pannello: Cristalli stampati trasparenti
Finitura alluminio: 301. verniciato nero RAL9005
 Maniglia senza supporto

Panel finish: Transparent patterned glass
Aluminium finish: 301. painted black RAL9005
 Handle without support



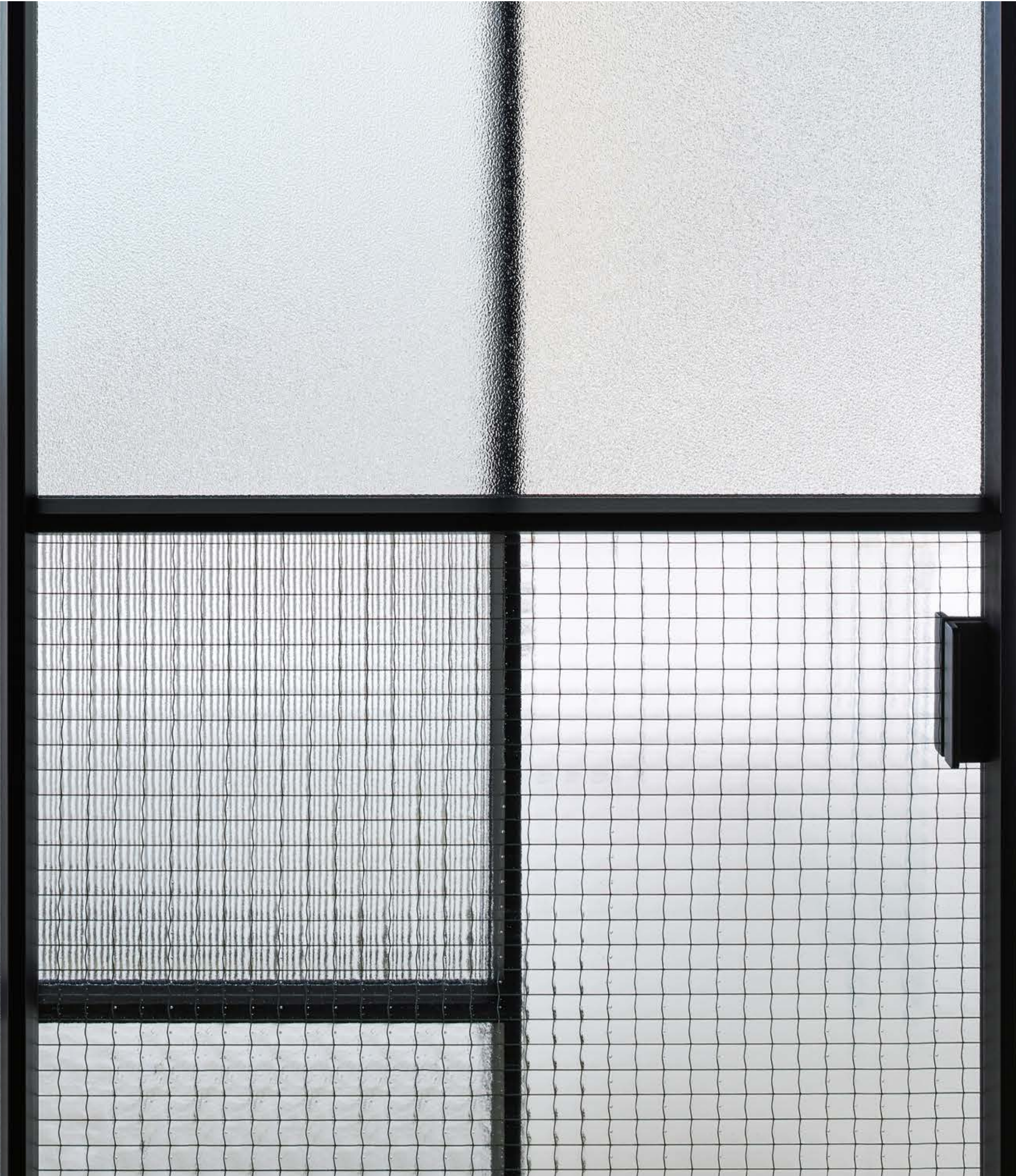
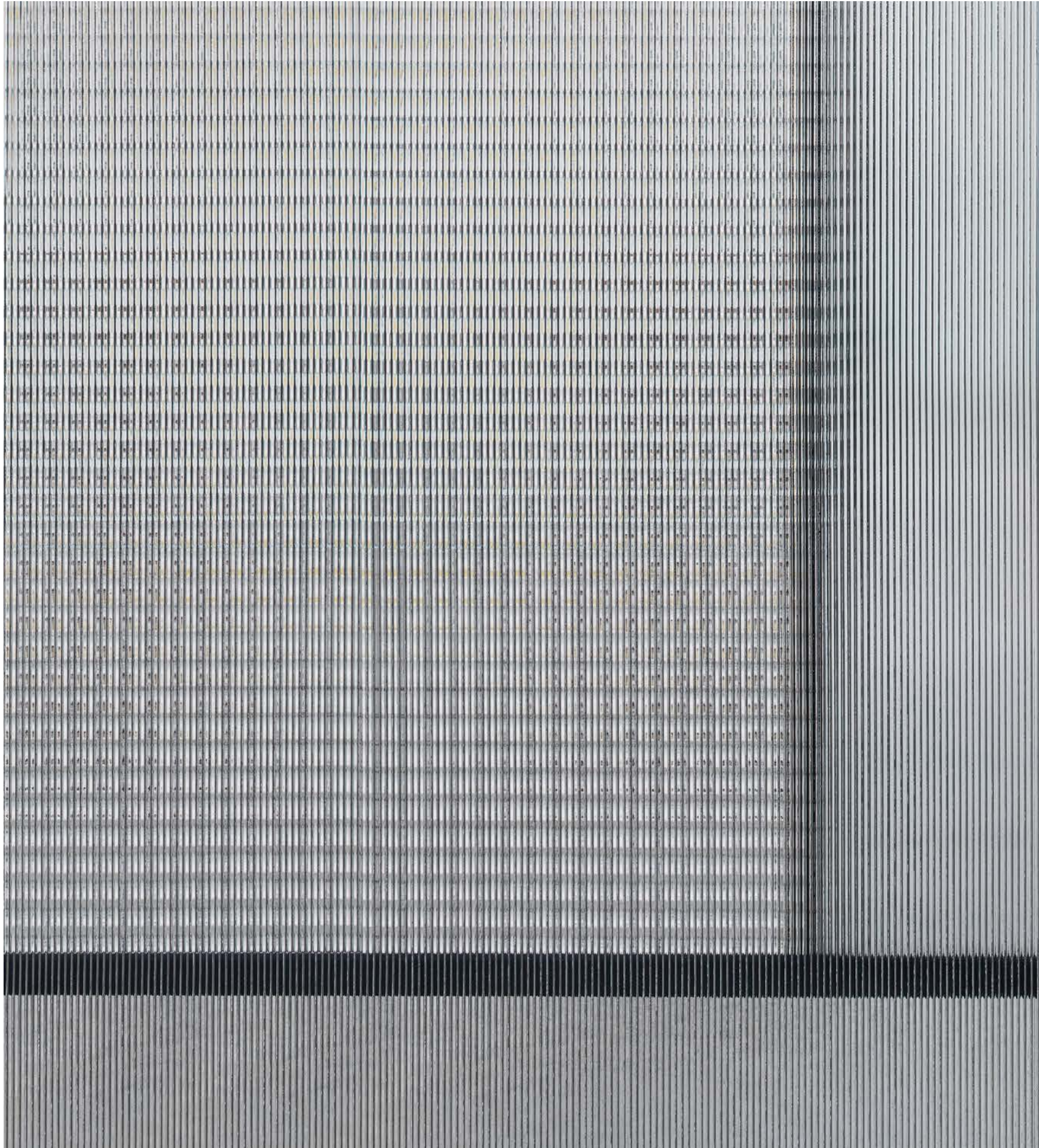





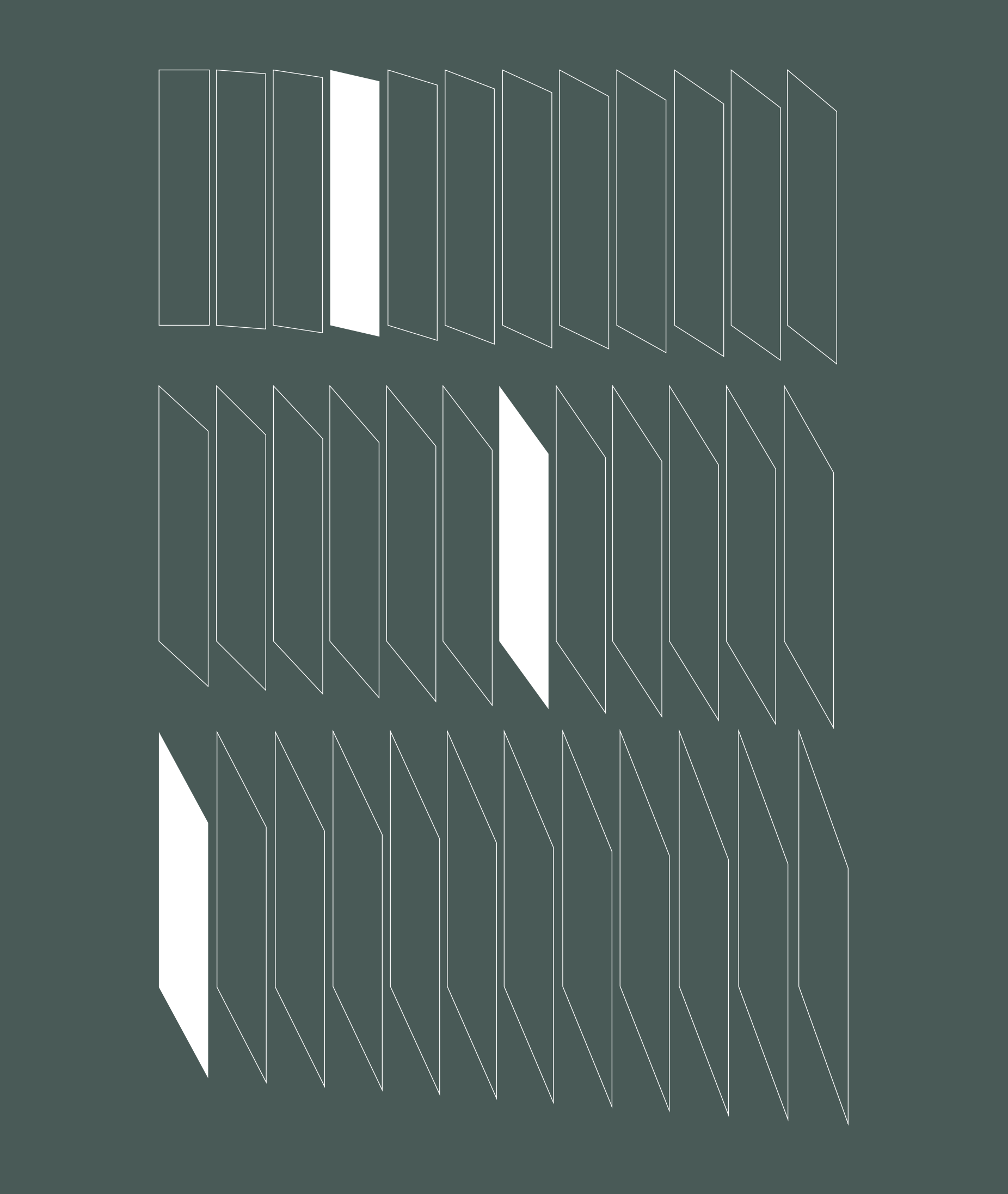







Finitura pannello: Cristalli extralight con tessuti - 551. raffaello
Finitura alluminio: 300. verniciato bianco RAL9016
Maniglia tonda senza supporto



Panel finish: Extralight glass with fabrics - 551. raffaello
Aluminium finish: 300. painted white RAL9016
Round handle without support





Finitura pannello: Cristalli extralight con tessuti - 551. raffaello
Finitura alluminio: 300. verniciato bianco RAL9016
Maniglia ovale senza supporto



Panel finish: Extralight glass with fabrics - 551. raffaello
Aluminium finish: 300. painted white RAL9016
Oval handle without support





Finitura pannello: Cristalli diffusori colorati opachi - 132. ambra
Finitura alluminio: 300. verniciato bianco RAL9016
 Maniglia tonda senza supporto



Panel finish: Opaque coloured diffuser glass - 132. ambra
Aluminium finish: 300. painted white RAL9016
 Round handle without support

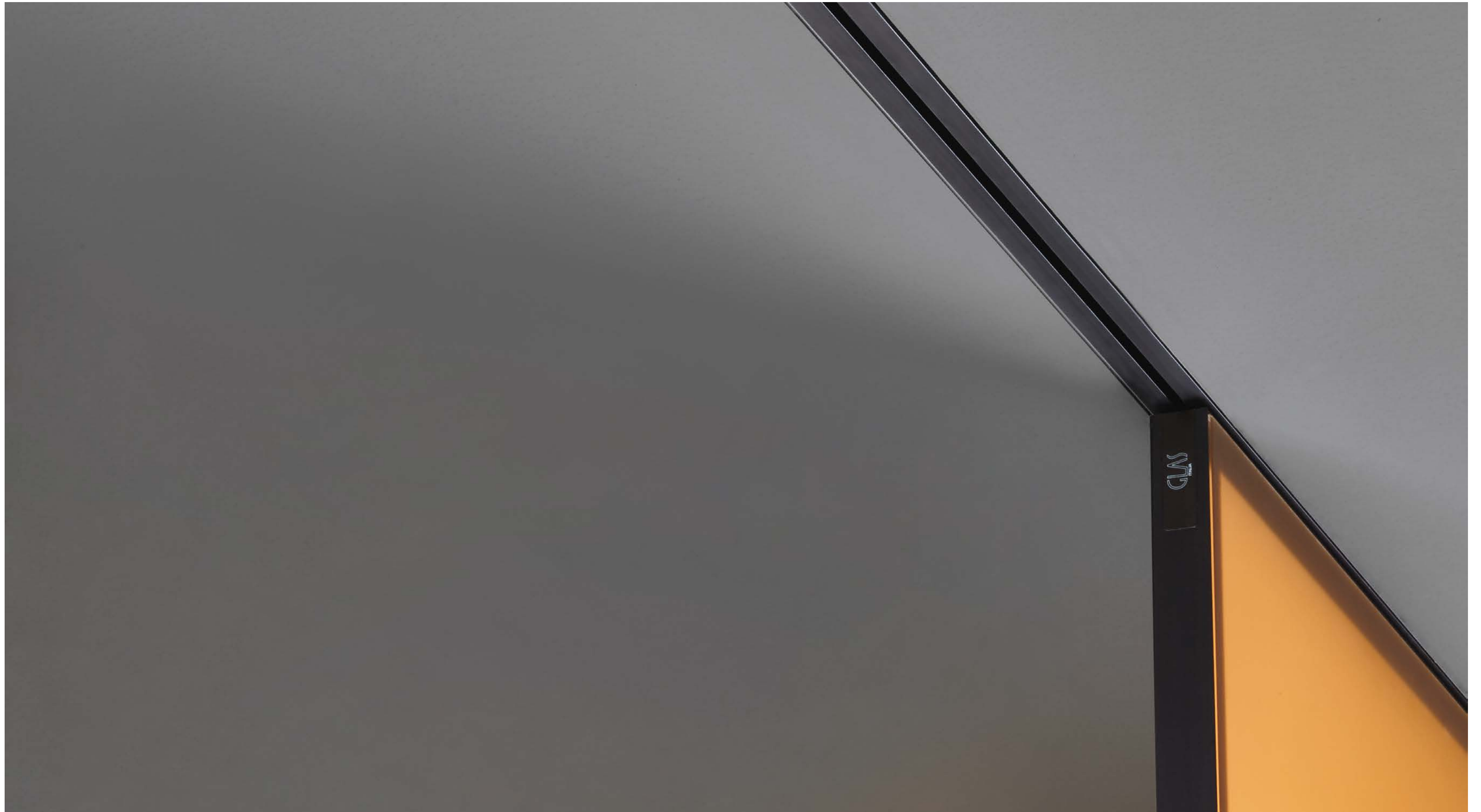





Finitura pannello: Cristalli trasparenti neutri - 501. fumé
Finitura alluminio: 315. anodizzato inox S
 Maniglia tonda senza supporto

Panel finish: Neutral transparent glass - 501. fumé
Aluminium finish: 315. anodized inox S
 Round handle without support







Finitura pannello: Cristalli decorati "Life" - 636. ramo
Finitura alluminio: 315. anodizzato inox S
Maniglia ovale senza supporto

Panel finish: "Life" decorated glass - 636. ramo
Aluminium finish: 315. anodized inox S
Oval handle without support









Finitura pannello: Cristalli extralight con tessuti - 556. pura seta crema
Finitura alluminio: 313. anodizzato bronzo S
 Maniglia con nottolino



Panel finish: Extralight glass with fabrics - 556. pura seta crema
Aluminium finish: 313. anodized bronze S
 Handle with revolving plug



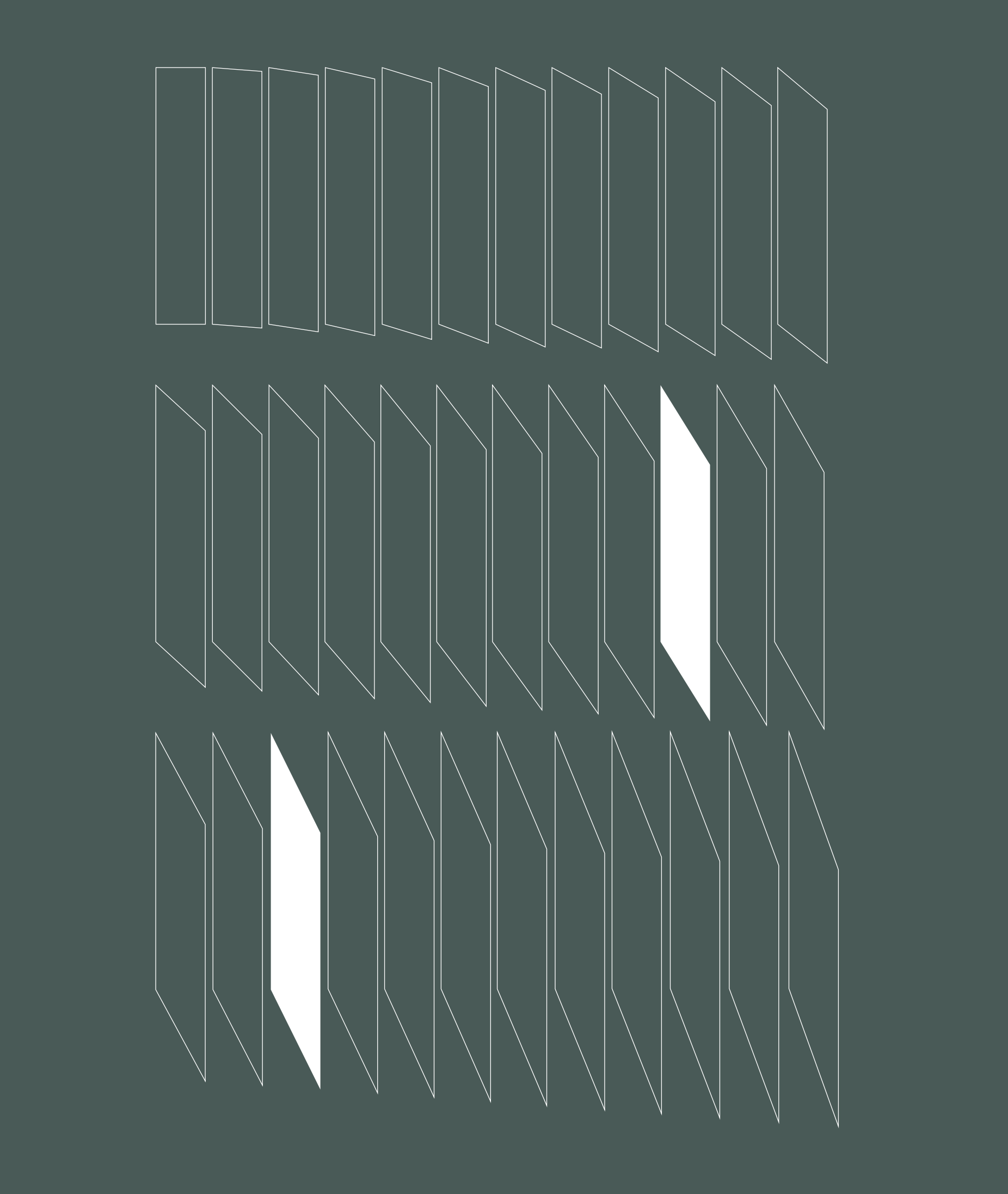







Finitura pannello: Cristalli acidati monofacciali - 601. Acidato monofacciale fumé

Finitura alluminio: 314. anodizzato dark brown S
Maniglia doppia con nottolino

Panel finish: Single faced acid-etched glass - 601. acidato monofacciale fumé

Aluminium finish: 314. anodized dark brown S
Double handle with revolving plug







Finitura pannello: Legni - 701. rovere fiammato sabbia
Finitura alluminio: 313. anodizzato bronzo S
Maniglia tonda senza supporto

Panel finish: Woods - 701. rovere fiammato sabbia
Aluminium finish: 313. anodized bronze S
Round handle without support









Finitura pannello: Cristalli extralight con tessuti - 553. botticelli
Finitura alluminio: 300. verniciato bianco RAL9016
 Maniglia con nottolino



Panel finish: Extralight glass with fabrics - 553. botticelli
Aluminium finish: 300. painted white RAL9016
 Handle with revolving plug







Finitura pannello: Cristalli stampati trasparenti - 523. quadretti
Finitura alluminio: 314. anodizzato dark brown S
Maniglia senza blocco

Panel finish: Transparent patterned glass - 523. quadretti
Aluminium finish: 314. anodized dark brown S
Handle without block







Finitura pannello: Legni - 704. ebano rigato
Finitura alluminio: 314. anodizzato dark brown S
 Maniglia con nottolino

Panel finish: Woods - 704. ebano rigato
Aluminium finish: 314. anodized dark brown S
 Handle with revolving plug



Sherazade Swing Plain





Finitura pannello: Cristallo extralight con tessuti - 556. pura seta crema

Finitura alluminio: 313. anodizzato bronzo S
Maniglia con nottolino

Panel finish: Extralight glass with fabrics - 556. pura seta crema
Aluminium finish: 313. anodized bronze S
Handle with revolving plug









Finitura pannello: Cristalli stampati trasparenti
Finitura alluminio: 301. verniciato nero RAL 9005
Maniglia senza blocco

Panel finish: Transparent patterned glass
Aluminium finish: 301. painted black RAL 9005
Handle without block



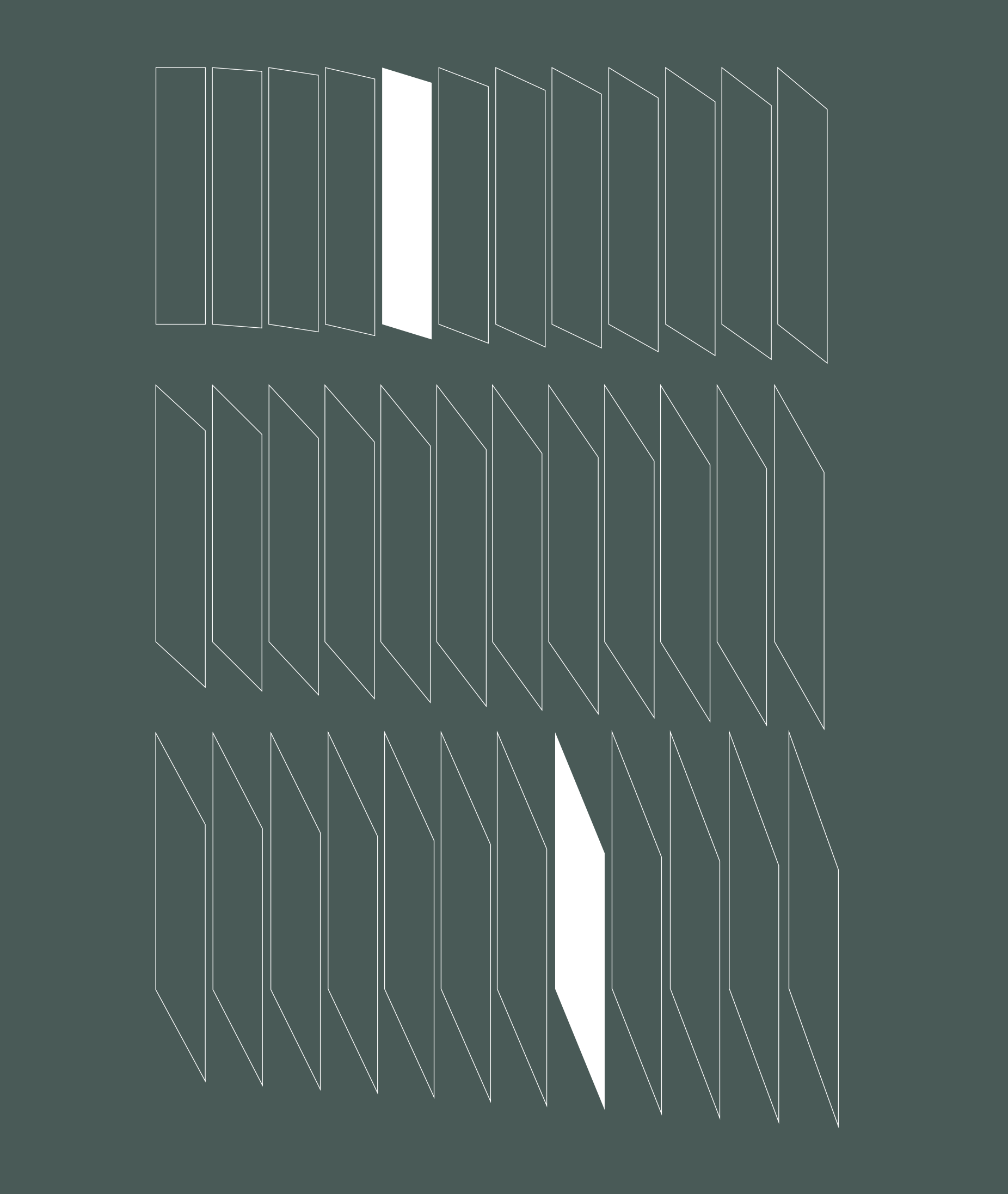







Finitura pannello: Cristalli stampati trasparenti - 523. quadretti
Finitura alluminio: 313. anodizzato bronzo S
Maniglia con nottolino

Panel finish: Transparent patterned glass - 523. quadretti
Aluminium finish: 313. anodized bronze S
Handle with revolving plug









18 / Sherazade Double Swing
Slim Jamb's Patchwork

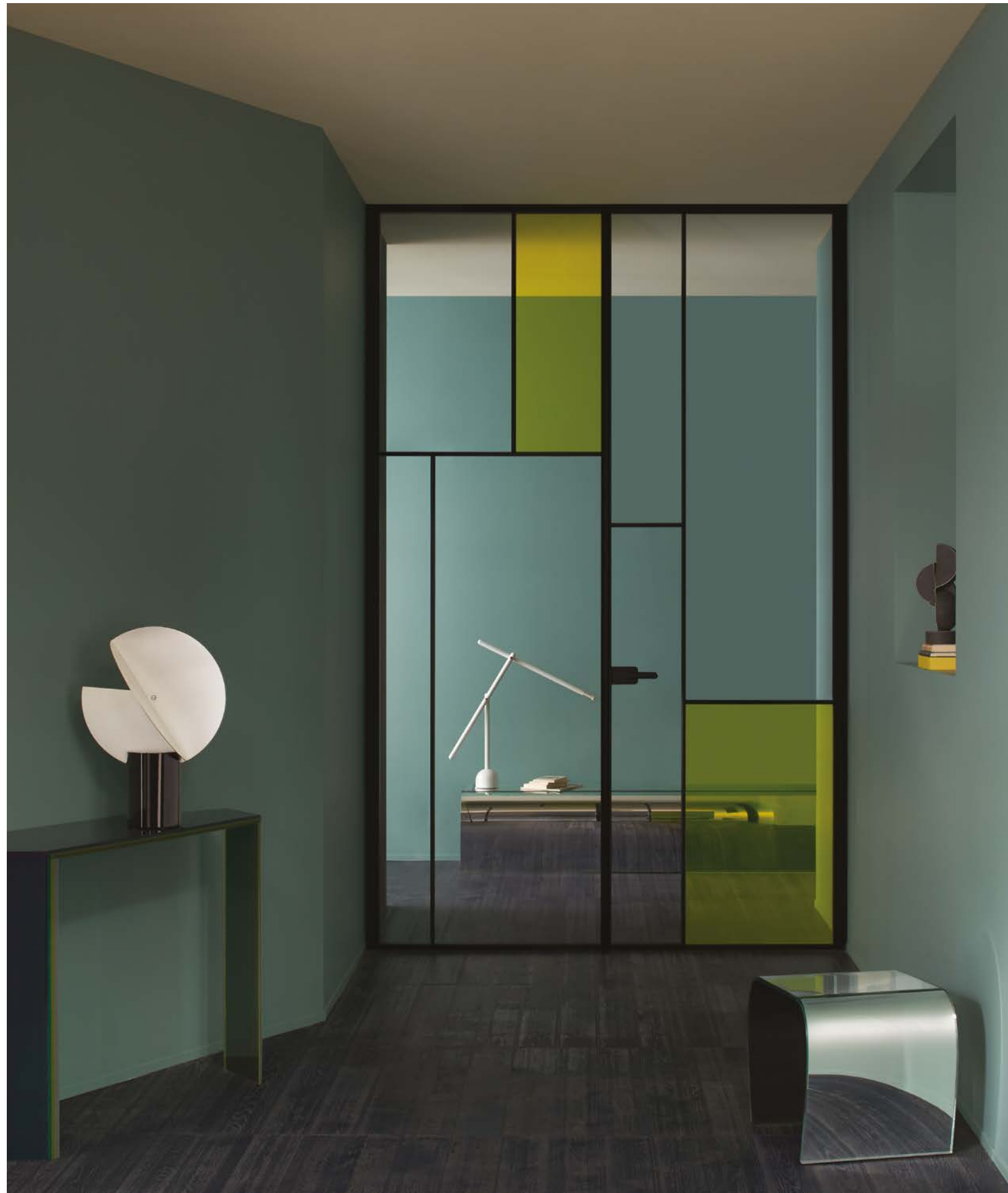

Finitura pannello: Cristalli trasparenti neutri – 500. extralight
Cristalli trasparenti colorati – 115.giallo sole
Finitura alluminio: 301. verniciato nero RAL 9005
Maniglia senza blocco



Panel finish: Neutral transparent glass – 500. extralight
Transparent coloured glass – 115. giallo sole
Aluminium finish: 301. painted black RAL 9005
Handle without block

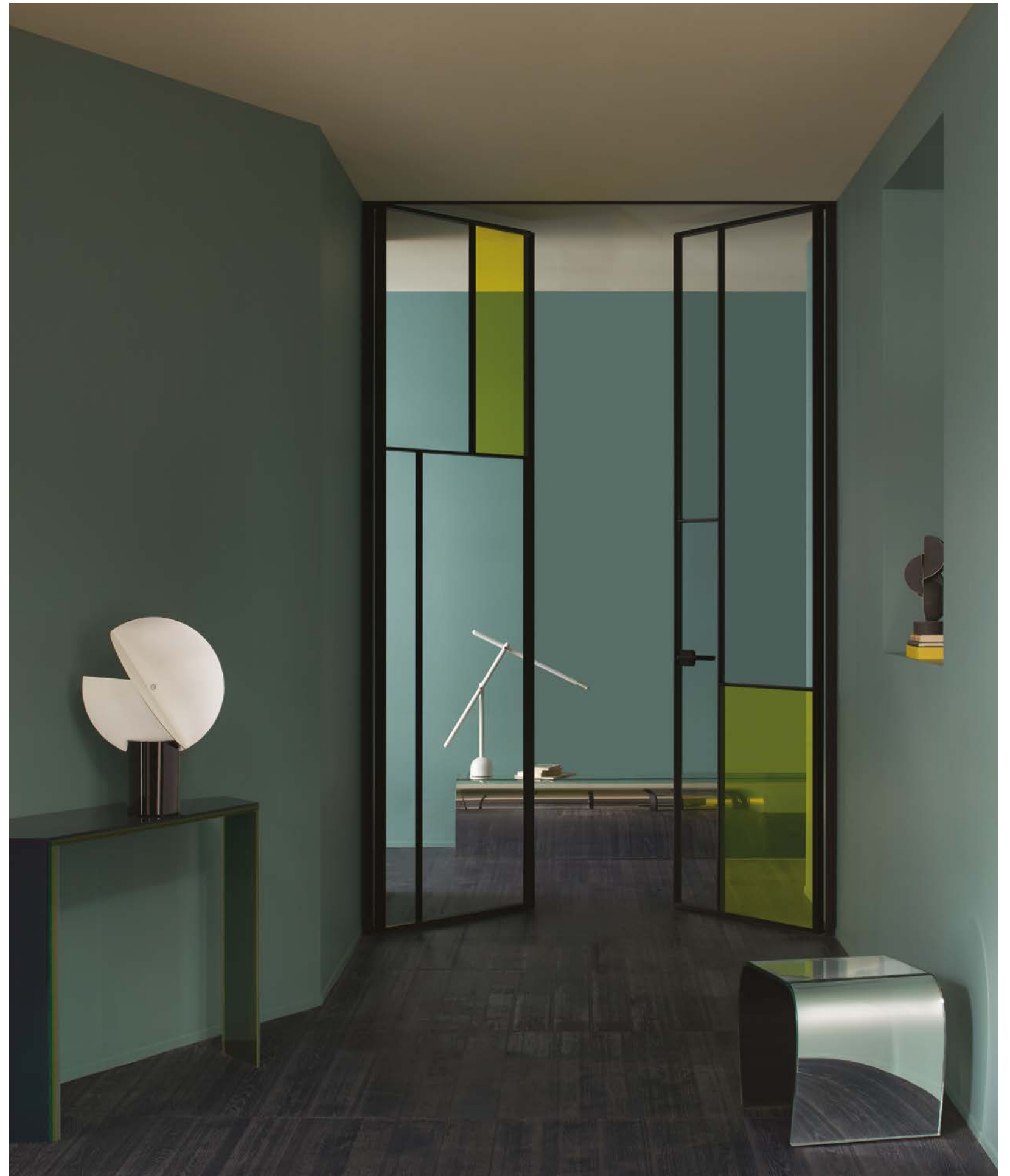







Finitura pannello: Cristalli acidati bifacciali - 604. acidato bifacciale fumé
Finitura alluminio: 314. anodizzato dark brown S
Maniglia senza blocco

Panel finish: Double faced acid-etched glass - 604. acidato bifacciale fumé
Aluminium finish: 314. anodized dark brown S
Handle without block







Finitura pannello: Cristallo extralight con tessuti - 552. masaccio
Finitura alluminio: 314. anodizzato dark brown S
Maniglia con chiusura privacy

Panel finish: Extralight glass with fabrics - 552. masaccio
Aluminium finish: 314. anodized dark brown S
Handle with privacy lock







Finitura pannello: Cristalli trasparenti colorati - 95. blu chiaro
Finitura alluminio: 300. verniciato bianco RAL9016
Pomolo senza blocco

Panel finish: Transparent coloured glass - 95. blu chiaro
Aluminium finish: 300. painted white RAL9016
Knob without block









Finitura pannello: Cristalli stampati trasparenti - 526. cattedrale
Finitura alluminio: 300. verniciato bianco RAL9016
Maniglia con chiusura privacy

Panel finish: Transparent patterned glass - 526. cattedrale
Aluminium finish: 300. painted white RAL9016
Handle with privacy lock





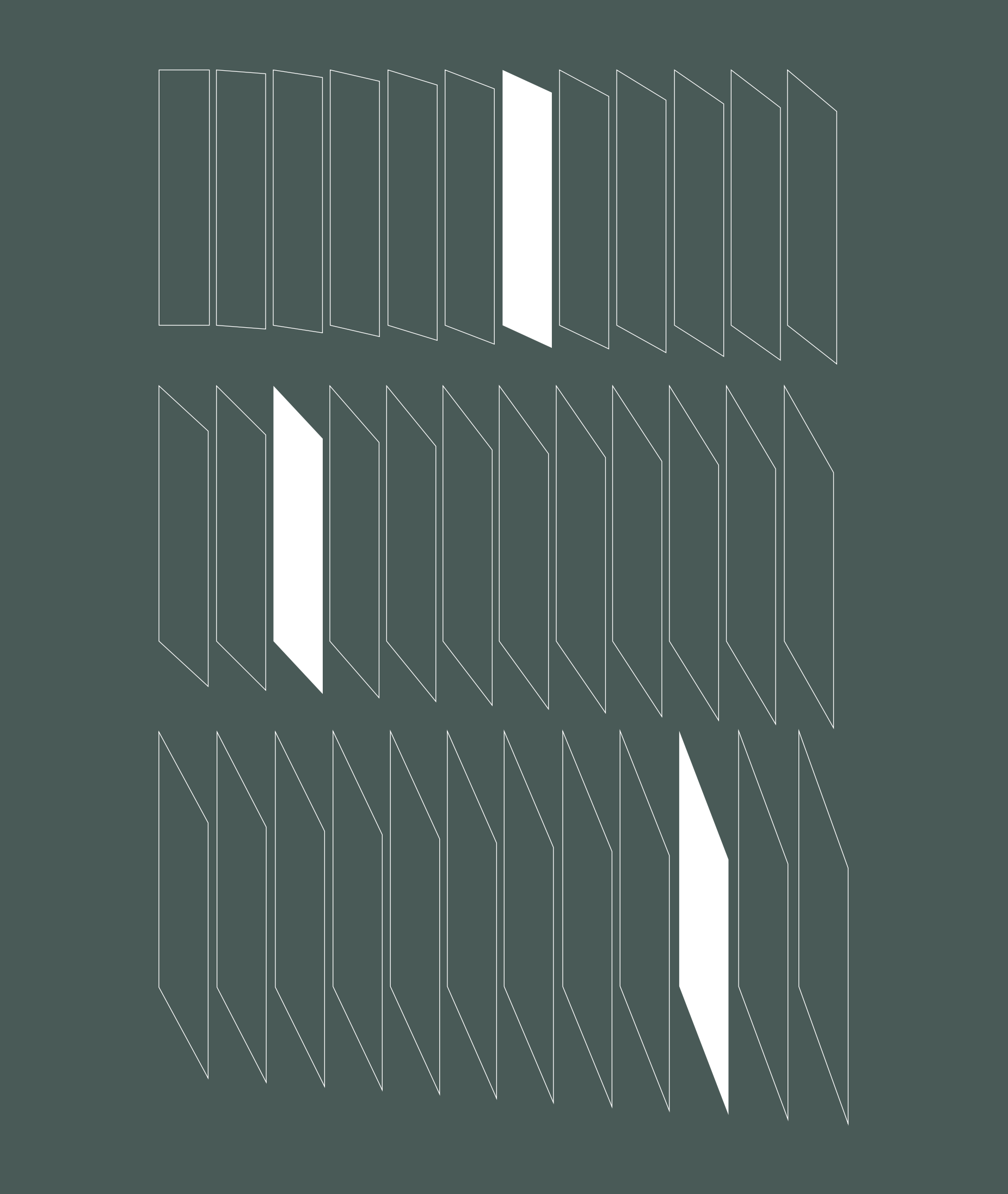





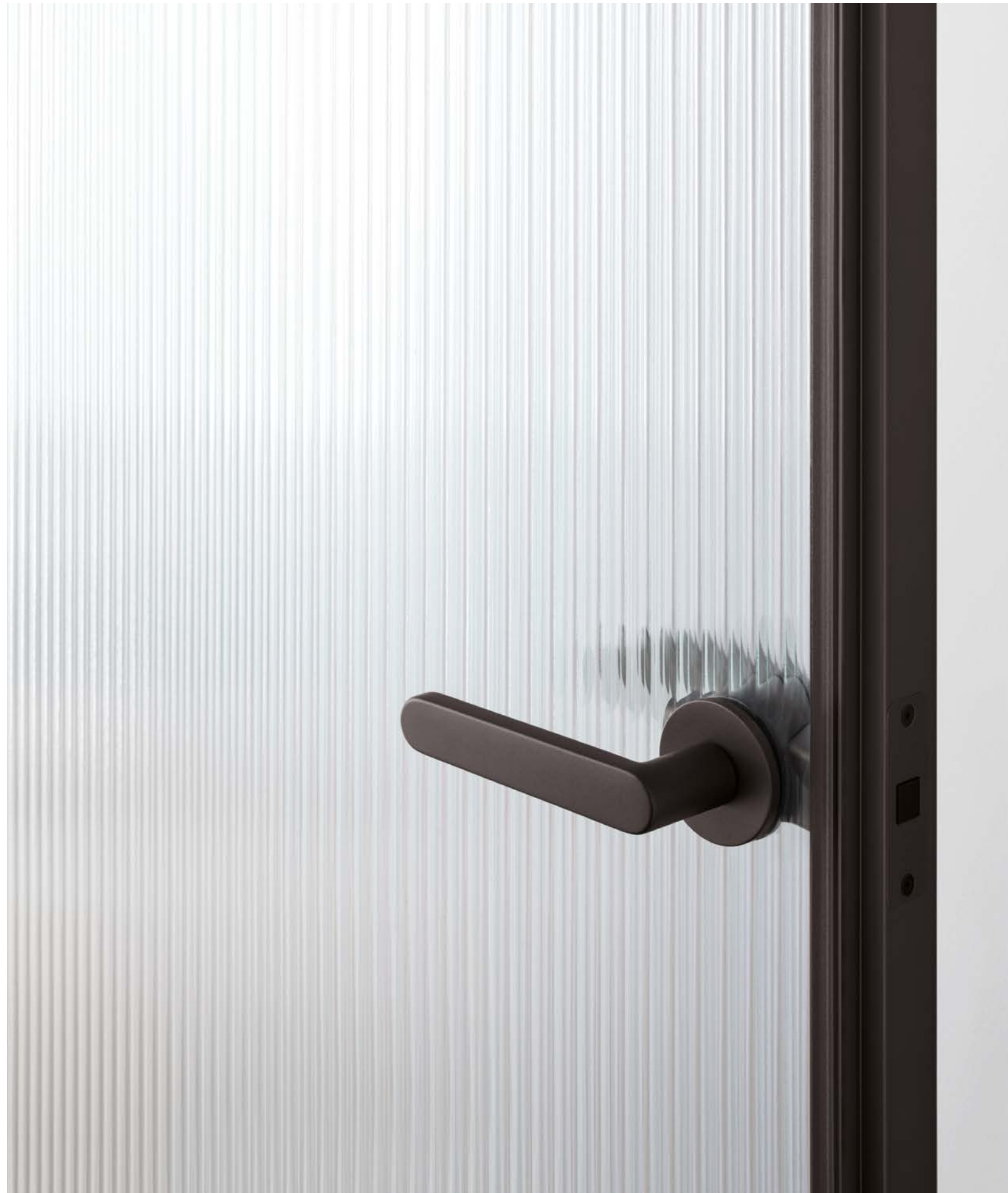

Finitura pannello: Cristalli stampati trasparenti - 520. flutes
Finitura alluminio: 314. anodizzato dark brown S
 Maniglia senza blocco



Panel finish: Transparent patterned glass - 520. flutes
Aluminium finish: 314. anodized dark brown S
 Handle without block



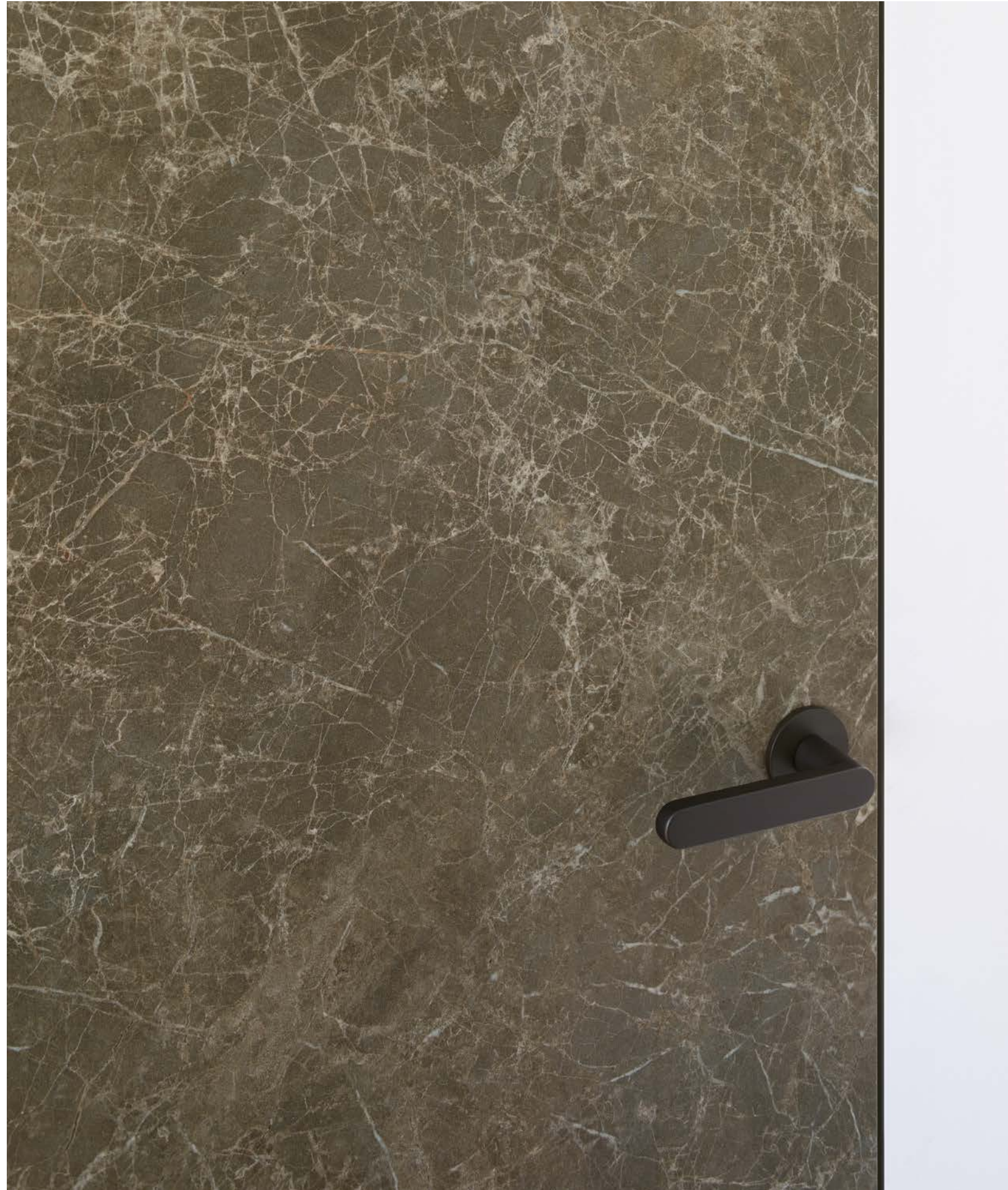

Finitura pannello: Gres - 807. marmo atlas marrone
Finitura alluminio: 314. anodizzato dark brown S
 Maniglia senza blocco



Aladin Swing Plain Duo



Panel finish: Stoneware - 807. marmo atlas marrone
Aluminium finish: 314. anodized dark brown S
 Handle without block

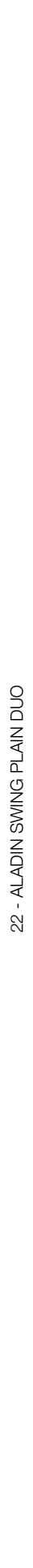



Finitura pannello: Gres - 800. pietra grigio chiaro
Finitura alluminio: 315. anodizzato inox S
Maniglia senza blocco



Panel finish: Stoneware - 800. pietra grigio chiaro
Aluminium finish: 315. anodized inox S
Handle without block





Finitura pannello: Gres - 801. pietra grigio medio
Finitura alluminio: 315. anodizzato inox S
 Maniglia senza blocco



Panel finish: Stoneware - 801. pietra grigio medio
Aluminium finish: 315. anodized inox S
 Handle without block





Finitura pannello: Cristallo extralight sfumato - 620. bianco
Finitura alluminio: 300. verniciato bianco RAL9016
Maniglia senza blocco



Panel finish: Shaded extralight glass - 620. bianco
Aluminium finish: 300. painted white RAL9016
Handle without block







Finitura pannello: Cristalli acidati monofacciali - 600. acidato monofacciale extralight

Finitura alluminio: 300. verniciato bianco RAL9016
Maniglia senza blocco

Panel finish: Single faced acid-etched extralight glass - 600. acidato monofacciale extralight

Aluminium finish: 300. painted white RAL9016

Handle without block









Finitura pannello: Cristallo extralight con tessuti - 555. carta di riso opaca
Finitura alluminio: 300. verniciato bianco RAL9016
 Maniglia senza blocco



Panel finish: Extralight glass with fabrics - 555. carta di riso opaca
Aluminium finish: 300. painted white RAL9016
 Handle without block



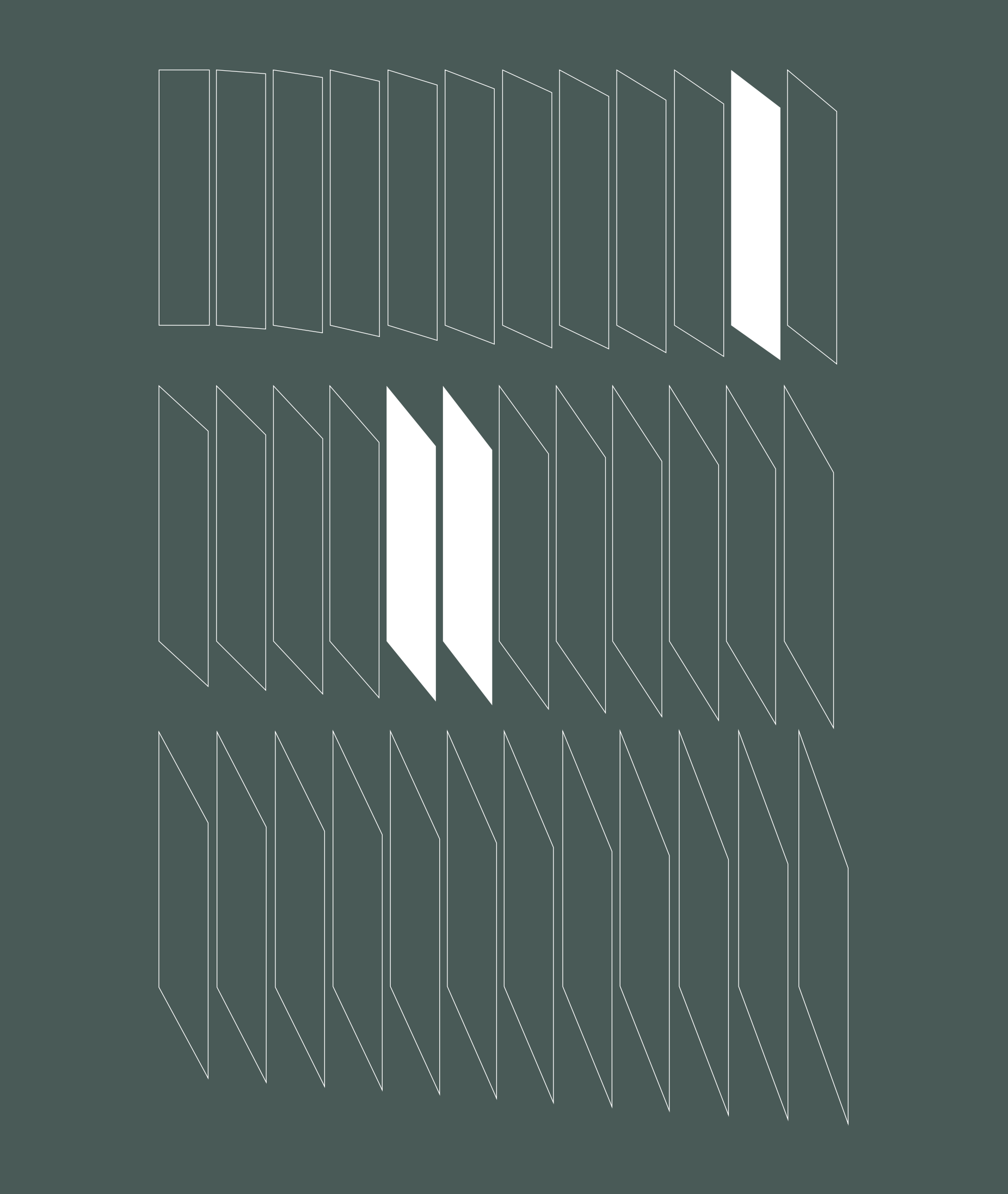





IT

Sherazade Wall è una parete divisoria terra-soffitto con un vetro stratificato mm 5+5 (o mm 4+6) posizionato al centro di un profilo d'alluminio e fissato tramite un sistema a scatto. La struttura d'alluminio è fornita in cinque diverse finiture e consente di eseguire significative regolazioni, per compensare le irregolarità degli ambienti. Nella parete sono integrabili tutti i modelli di porte a battente e scorrevoli Glas Italia, coordinate con le stesse finiture o con finiture diverse (attenzione, non tutte le tipologie di vetro utilizzabili nella parete sono disponibili in ogni modello di porta). Il vetro, disponibile in una vastissima gamma di finiture, è certificato secondo le normative di sicurezza ANSI Z97.1 e UNI EN12150. Sono disponibili anche pannelli in gres in diverse finiture.

REGOLAZIONE DELLA PARETE

- Soffitto 14 mm.
- Pavimento 3 mm.

EN

Sherazade Wall is a floor to ceiling partition wall with a 5+5mm (or 4+6mm) laminated glass positioned in the center of an aluminum profile and installed with a 'click-on' system. The aluminum structure is supplied in five different finishes and allows significant adjustments to compensate construction irregularities. All Glas Italia hinged and sliding doors can be integrated into this system, coordinated with the same finishes or with different finishes (attention: not all types of glass that can be used in the partition wall, are available for every door model). The glass is available in a very wide range of finishes, and it is certified according to the ANSI Z97.1 and UNI EN12150 safety standards. In the collection are also available stoneware slabs in different finishes.

WALL ADJUSTMENT

- Ceiling: 14 mm.
- Floor: 3 mm.

FR

Sherazade Wall est une cloison sol-plafond avec un verre stratifié mm 5+5 mm d'épaisseur (ou 4+6 mm) positionné au centre d'un profil en aluminium et fixé par un système à pression. La structure en aluminium, disponible en cinq finitions différentes, permet de faire des réglages importants pour compenser les irrégularités des espaces. Tous les modèles de portes battantes et coulissantes Glas Italia peuvent être intégrés avec cette paroi, coordonnés avec les mêmes finitions ou avec des finitions différentes (attention, tous les types de verre pouvant être utilisés pour la paroi, ne sont pas disponibles pour tous les modèles de porte). Les verres, disponibles dans une vaste gamme de finitions, sont certifiés selon les normes de sécurité ANSI Z97.1 et UNI EN12150. Panneaux en grès et bois en différentes finitions et essences sont également disponibles.

RÉGLAGE DE LA CLOISON

- Plafond: 14 mm.
- Sol: 3 mm.

**DE**

Sherazade Wall ist eine Boden-Decke Trennwand aus 5+5 mm. (oder 4+6) stark beschichtetem Glas, das in der Mitte eines Aluminiumrahmens eingesetzt und mit einem Klick-System befestigt ist. Die Aluminiumstruktur, erhältlich in fünf verschiedenen Ausführungen, wird mit einem Anpassungssystem geliefert, das eine bedeutende Justierungsmöglichkeit erlaubt, um die Unregelmäßigkeiten des Raumes auszugleichen. Die Trennwände sind kombinierbar mit allen Glas Italia Modellen von Dreh- und Schiebetüren und können in den gleichen oder verschiedenen Ausführungen abgestimmt werden. (Achtung: nicht alle Glastypologien, die für die Trennwände verfügbar sind, können für jedes Türmodell verwendet sein). Das Glas ist in zahlreichen Ausführungen erhältlich und ist gemäß ANSI Z97.1 und UNI EN12150 zertifiziert. Gres- und Holzpaneele in verschiedenen Ausführungen sind ebenfalls erhältlich.

TRENNWANDJUSTIERUNG

- Decke: 14 mm.
- Boden: 3 mm.

ES

Sherazade Wall es una pared divisoria, suelo-techo, con un cristal estratificado 5+5 mm. (o 4+6 mm.) aplicado en el centro de un perfil de aluminio y fijado por medio de un sistema a presión. La estructura de aluminio, disponible en cinco acabados diferentes, permite de hacer significativas regulaciones para compensar las irregularidades de los ambientes. En las paredes se pueden integrar todos los modelos de puertas batientes y correderas Glas Italia, coordinadas en los mismos acabados o con acabados diferentes (atención: no todos los tipos de cristal que se pueden utilizar en las paredes están disponibles en cada modelo de puerta). El cristal, disponible en una amplia gama de acabados, está certificado según las normativas de seguridad ANSI Z97.1 y UNI EN12150. Están disponibles también paneles de gres con diferentes acabados.

REGULACIÓN PARED

- Techo: 14 mm.
- Suelo: 3 mm.

Sherazade Wall

PANNELLI SHERAZADE WALL / SHERAZADE WALL PANELS

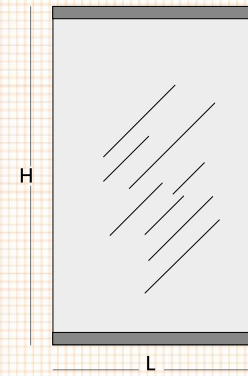

PROFILO VERTICALE CONTRO MURO / WALL MOUNTED PROFILE

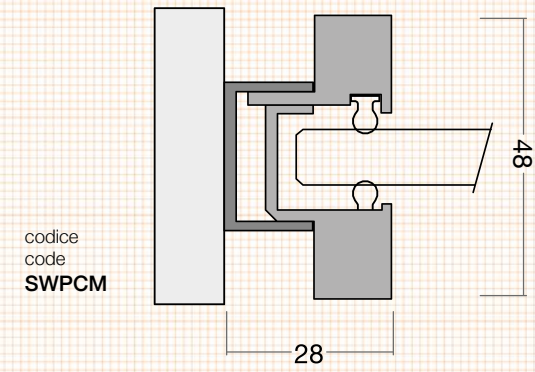

PROFILO VERTICALE CENTRO STANZA / CENTRAL VERTICAL PROFILE

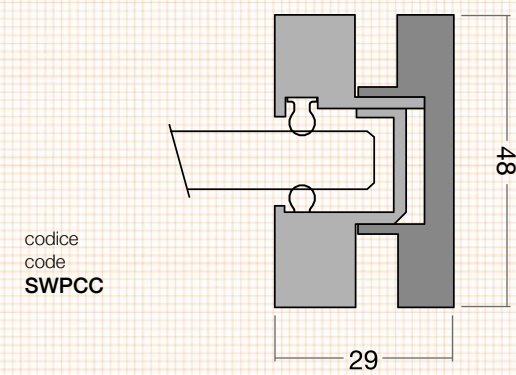

PROFILO PER PORTA BATTENTE / SWING DOOR PROFILE

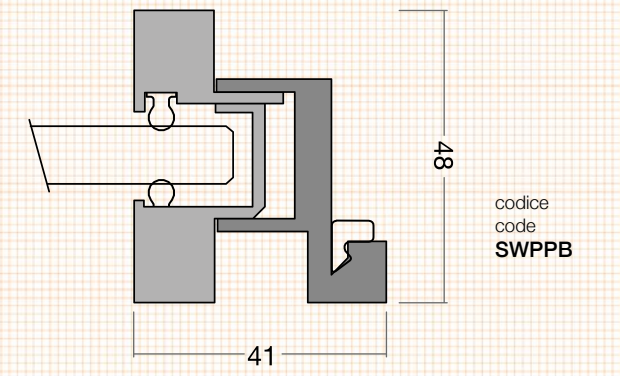

PROFILO PER PORTA BATTENTE POSIZIONATA A MURO / PROFILE FOR SWING DOOR PLACED AGAINST THE WALL

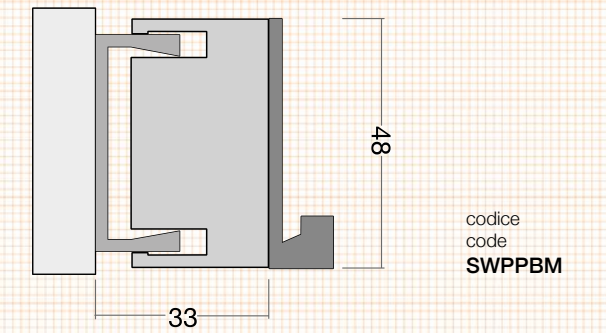

PROFILO VERTICALE PER ABBASSAMENTO / WALL MOUNTED PROFILE FOR DROP CEILING

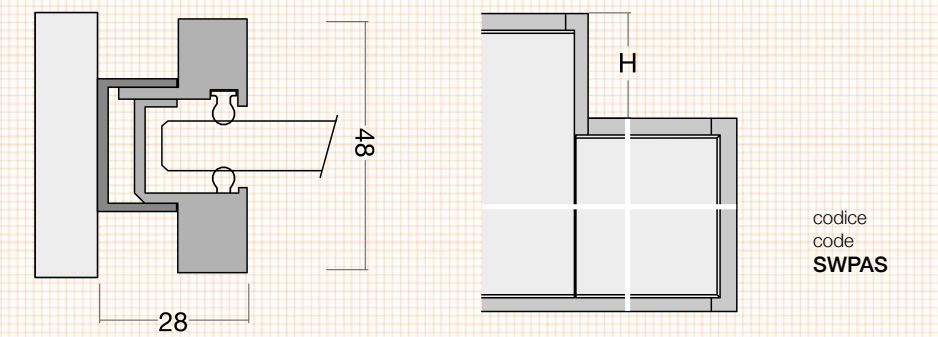

Sherazade Wall

NODO A 2 VIE CON PORTA BATTENTE / 2 WAYS JOINT WITH SWING DOOR

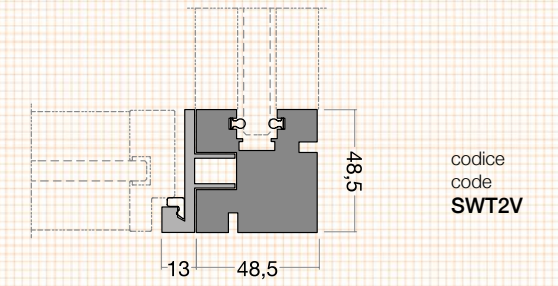

NODO A 3 VIE CON 2 PORTE BATTENTI / 3 WAYS JOINT

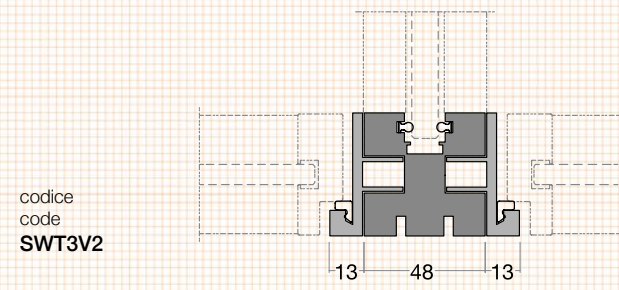

MODULO TECNICO / TECHNICAL MODUL

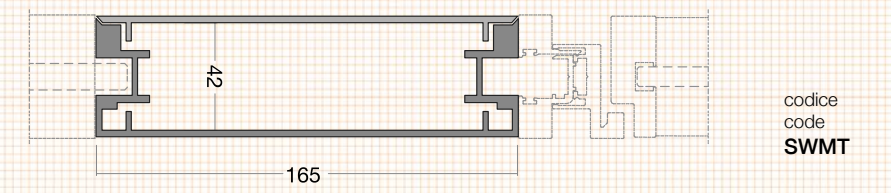

NODO A 3 VIE CON PORTA BATTENTE / 3 WAYS JOINT WITH SWING DOOR

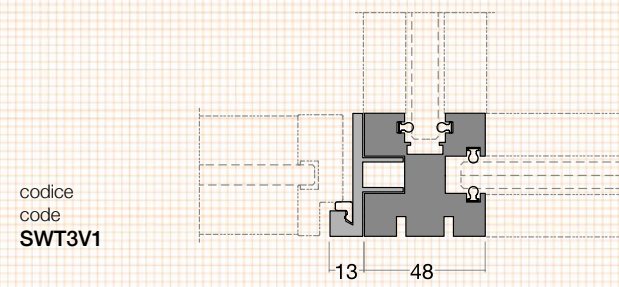

Sherazade Wall

ANGOLO A 90 GRADI / 90 DEGREE ANGLE

codice
code
SW90

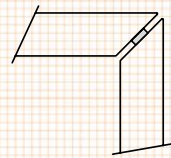

ANGOLO A GRADI VARIABILI CON BIADESIVO / VARIABLE DEGREES ANGLE

codice
code
SWG V



SNODO 3 VIE / 3 WAYS JOINT

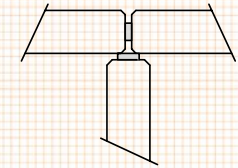

codice
code
SW3V

SNODO A 3 VIE AD ANGOLI VARIABILI CON BIADESIVO / VARIABLE ANGLES 3 WAYS JOINT

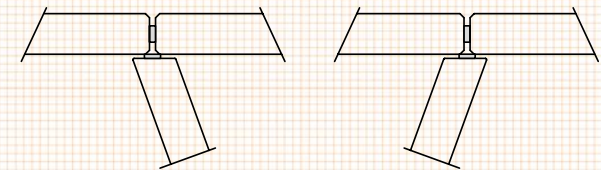

codice
code
SW3V V

Sherazade Wall

CONFIGURAZIONE PARETE LINEARE CON PORTA / LINEAR WALL CONFIGURATION WITH DOOR

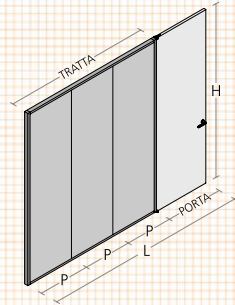

codice
code
SWPLSW Anta battente / Swing door

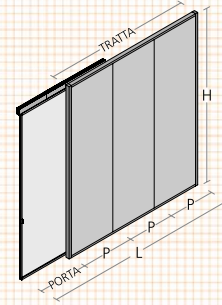

codice
code
SWPLSL Anta scorrevole / Sliding door

CONFIGURAZIONE PARETE LINEARE CON PORTA / LINEAR WALL CONFIGURATION WITH DOOR

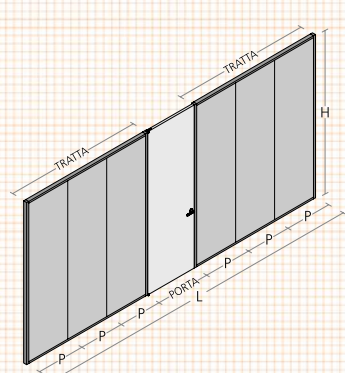

codice
code
SWPLSW Anta battente / Swing door

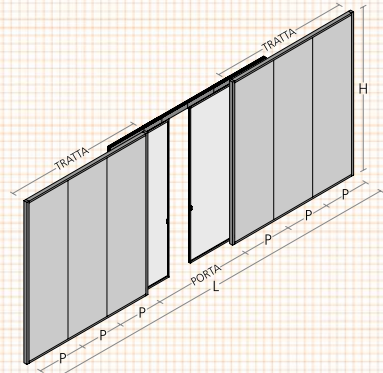

codice
code
SWPLSL Anta scorrevole / Sliding door

CONFIGURAZIONE PARETE CON SNODO 3 VIE E PORTE / WALL COMPOSITION WITH 3 WAYS JOIN AND DOORS

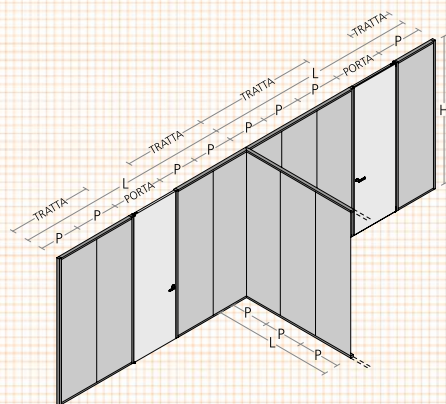

codice
code
SWPS3VSW Anta battente / Swing door

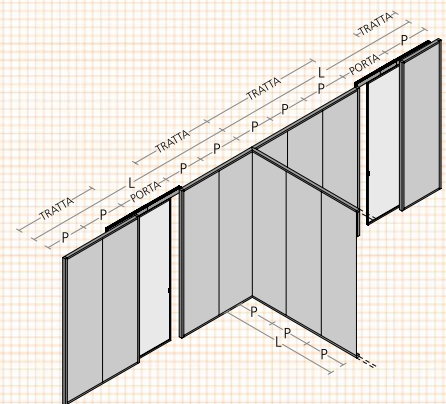

codice
code
SWPS3VSL Anta scorrevole / Sliding door

CONFIGURAZIONE PARETE ANGOLARE CON PORTA / ANGULAR COMPOSITION WITH DOOR

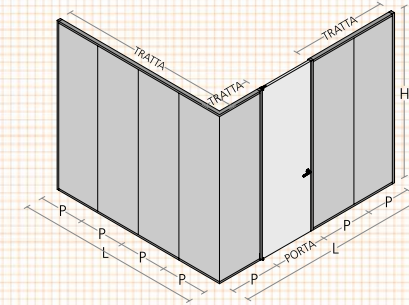

codice
code
SWPASW Anta battente / Swing door

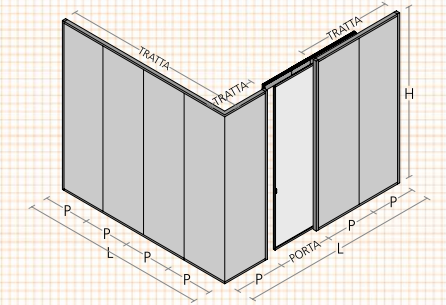

codice
code
SWPASL Anta scorrevole / Sliding door

CONFIGURAZIONE PENISOLA CON PORTA / PENINSULA WALL COMPOSITION WITH DOOR

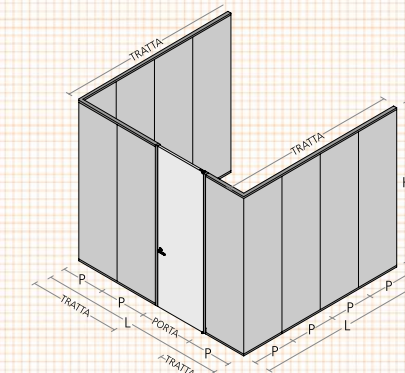

codice
code
SWPSW Anta battente / Swing door

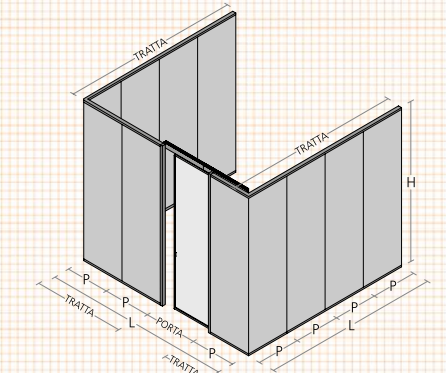

codice
code
SWPSL Anta scorrevole / Sliding door

CONFIGURAZIONE ISOLA CON PORTA / ISLAND FREE STANDING WALL COMPOSITION WITH DOOR

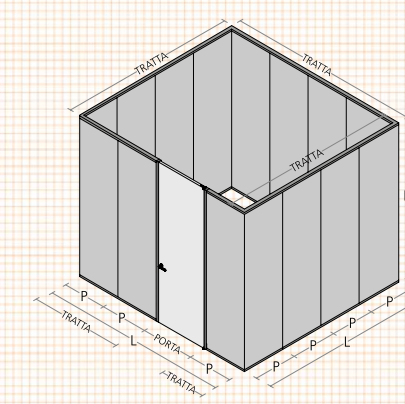

codice
code
SWISW Anta battente / Swing door

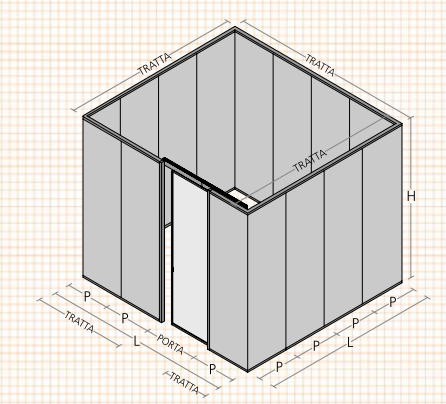

codice
code
SWISL Anta scorrevole / Sliding door

IT

Sherazade Wall Patchwork è una parete divisoria terra-soffitto di grande eleganza e cura dei dettagli, composta da pannelli affiancabili, ripartiti in quattro riquadri, nei quali possono essere installati diversi tipi di cristalli temperati monolitici mm.6 o stratificati 3+3 mm.

Tutti i profili in alluminio e la componentistica sono disponibili in cinque diverse finiture. È possibile eseguire significative regolazioni, per compensare le irregolarità degli ambienti. Nella parete sono integrabili tutti i modelli di porte a battente e scorrevoli Glas Italia, coordinate con le stesse finiture o con finiture diverse. Il vetro, disponibile in una vastissima gamma di finiture, è certificato secondo le normative di sicurezza ANSI Z97.1 e UNI EN12150. Sono disponibili anche pannelli in gres in diverse finiture.



EN

Sherazade Wall Patchwork is a floor-to-ceiling partition wall of great elegance and attention to detail, comprising adjacent panels divided into four panes, featuring different types of monolithic tempered glass 6mm or laminated 3+3mm.

All aluminum profiles, handles and components are available in five different finishes. It is possible to make significant adjustments during installation to compensate for building construction irregularities. All Glas Italia door designs of hinged and sliding doors can be integrated into the system, coordinated with the same finishes or with a different finish.

The glass is available in a very wide range of finishes and is certified according to the ANSI Z97.1 and UNI EN12150 safety standards. There are stoneware panels in different finishes as well.

DE

Sherazade Wall Patchwork ist eine Boden-Decke Trennwand von großer Eleganz und Sorgfalt zum Detail, bestehend aus nebeneinander liegenden Paneelen, die auf vier Felder aufgeteilt sind, wo unterschiedliche Glastypologien von 6 mm starken monolithischem gehärtetem Gläsern oder 3 + 3 mm starken beschichteten Gläsern eingebaut werden können. Alle Aluminiumprofile und Komponente sind in fünf verschiedenen Ausführungen erhältlich. Bedeutende Anpassungen können vorgenommen werden, um die Unregelmäßigkeiten des Raumes auszugleichen. Alle Modelle von Glas Italia Dreh- und Schiebetüren können mit dieser Trennwand integriert werden, kombiniert mit den gleichen Ausführungen oder mit unterschiedlichen Ausführungen. Das Glas, das in einer sehr breiten Palette von Ausführungen erhältlich ist, ist gemäß ANSI Z97.1 und UNI EN12150 Sicherheitsvorschriften zertifiziert. Feinsteinzeug- und Holzpaneele in verschiedenen Ausführungen sind ebenfalls erhältlich.

FR

Sherazade Wall Patchwork est une cloison sol-plafond de grande élégance et soin des détails, composée par de panneaux juxtaposés, dont la surface est divisée en quatre encarts, dans lesquels différents types de verre trempé monolithique mm.6 ou stratifié 3 + 3 mm peuvent être positionnés. Tous les profils en aluminium et les composants sont disponibles en cinq finitions différentes. Des réglages importants peuvent être effectués pour compenser les irrégularités des environnements.

Tous les modèles de portes battantes et coulissantes de Glas Italia peuvent être intégrés dans la cloison, coordonnés avec des finitions identiques ou différentes. Les verres, disponibles dans une vaste gamme de finitions, sont certifiés selon les normes de sécurité ANSI Z97.1 et UNI EN12150. Panneaux en grès en différentes finitions sont également disponibles.

ES

Sherazade Wall Patchwork es un tabique de suelo a techo de gran elegancia y atención al detalle, compuesto por paneles uno al lado del otro, dividido en cuatro cuadrados, en el que se pueden colocar diferentes tipos de vidriotemplado monolítico de mm.6 o estratificado 3 + 3 mm estar instalado. Todos los perfiles y componentes de aluminio están disponibles en cinco acabados diferentes. Se pueden realizar ajustes importantes para compensar entornos desiguales. Todos los modelos de puertas abatibles y correderas Glas Italia pueden integrarse en la pared, coordinadas con los mismos acabados o con diferentes acabados. El vidrio, disponible en una amplia gama de acabados, está certificado según las normas de seguridad ANSI Z97.1 y UNI EN12150. También hay paneles de gres en diferentes acabados.

Sherazade Wall Patchwork

PANNELLI SHERAZADE WALL PATCHWORK / SHERAZADE WALL PATCHWORK PANELS

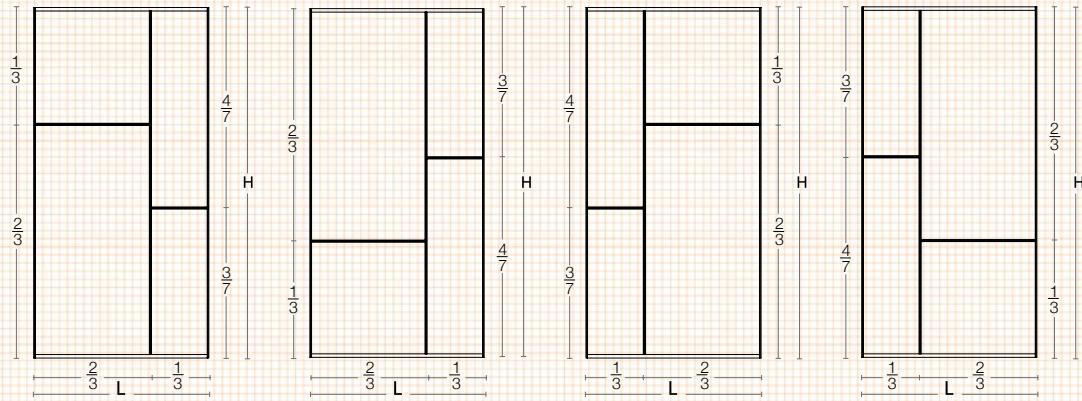

codice / code :
SWP01

codice / code :
SWP02

codice / code :
SWP03

codice / code :
SWP04

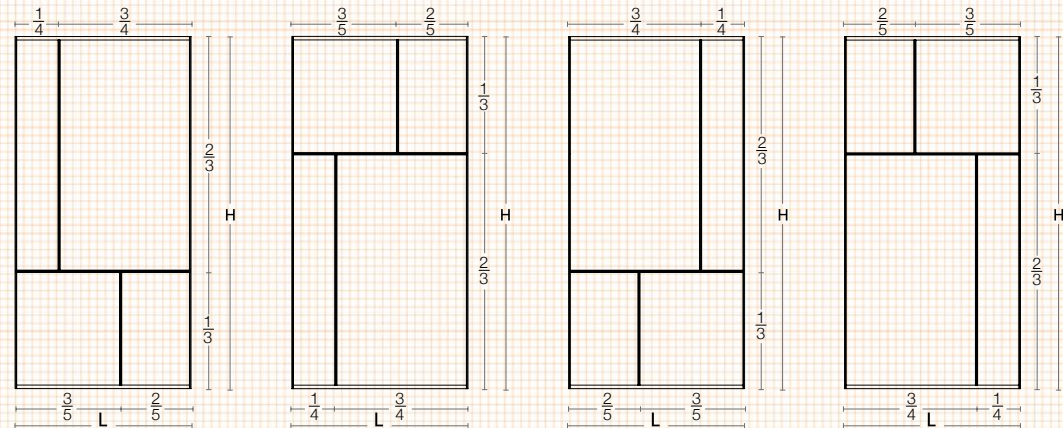

codice / code :
SWP05

codice / code :
SWP06

codice / code :
SWP07

codice / code :
SWP08

PROFILO VERTICALE CONTRO MURO / WALL MOUNTED PROFILE

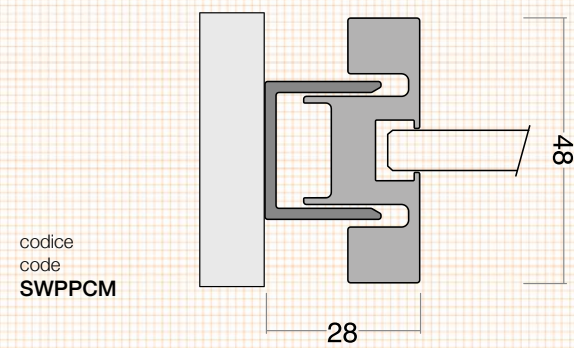

codice
code
SWPPCM

PROFILO VERTICALE CENTRO STANZA / CENTRAL VERTICAL PROFILE

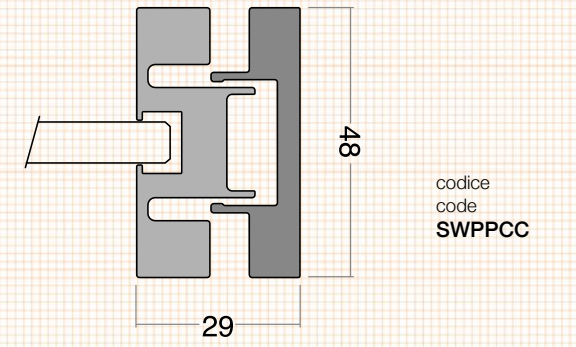

codice
code
SWPPCC

PROFILO PER PORTA BATTENTE / SWING DOOR PROFILE

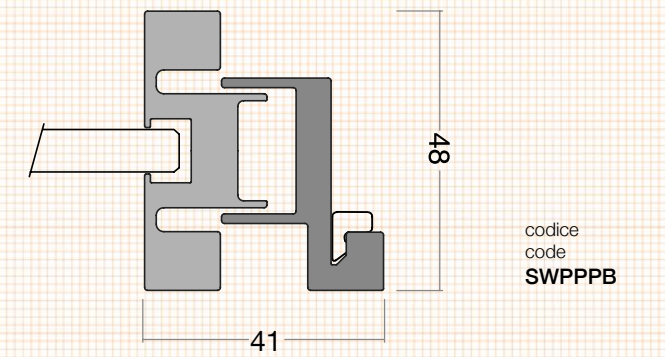

codice
code
SWPPPB

PROFILO PER PORTA BATTENTE POSIZIONATA A MURO / PROFILE FOR SWING DOOR PLACED AGAINST THE WALL

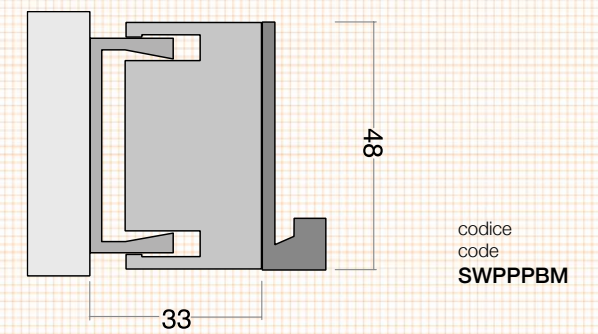

codice
code
SWPPPBM

Sherazade Wall Patchwork

NODO A 2 VIE CON PORTA BATTENTE / 2 WAYS JOINT WITH SWING DOOR

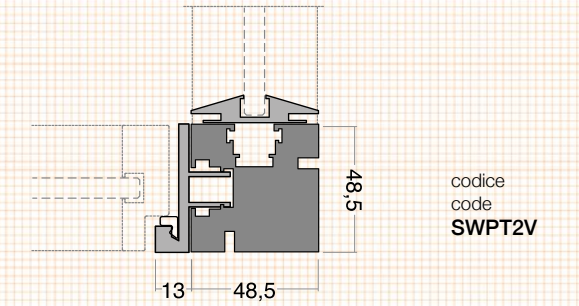

NODO A 3 VIE CON 2 PORTE BATTENTI / 3 WAYS JOIN

codice
code
SWPT3V2

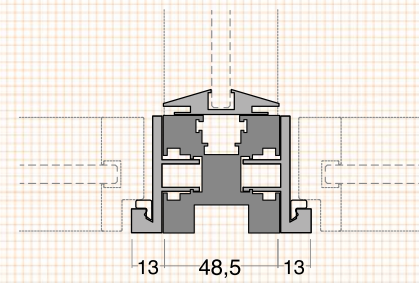

MODULO TECNICO / TECHNICAL MODUL

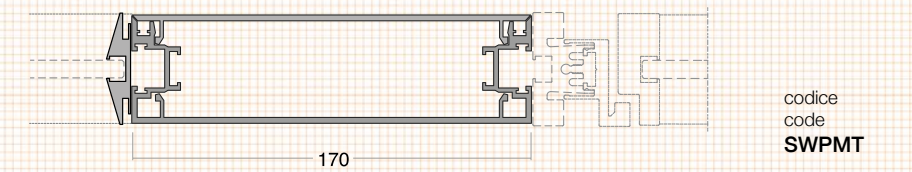

NODO A 3 VIE CON PORTA BATTENTE / 3 WAYS JOINT WITH SWING DOOR

codice
code
SWPT3V1

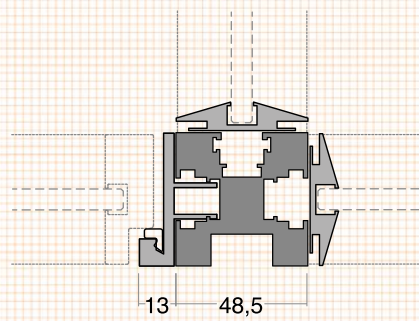

Sherazade Wall Patchwork

CONFIGURAZIONE PARETE LINEARE CON PORTA / LINEAR WALL CONFIGURATION WITH DOOR

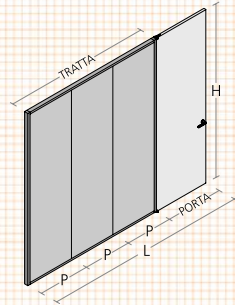

codice
code
SWPPLSW Anta battente / Swing door

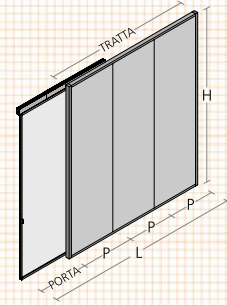

codice
code
SWPPLSL Anta scorrevole / Sliding door

CONFIGURAZIONE PARETE LINEARE CON PORTA / LINEAR WALL CONFIGURATION WITH DOOR

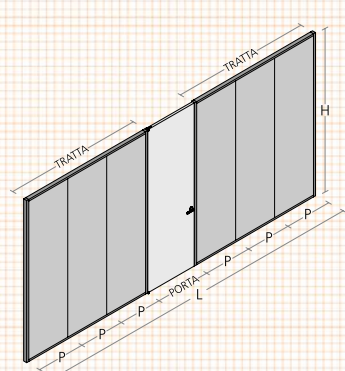

codice
code
SWPPLSW Anta battente / Swing door

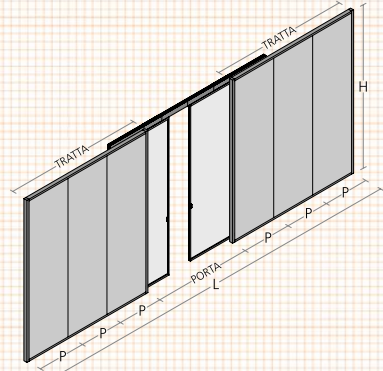

codice
code
SWPPLSL Anta scorrevole / Sliding door

CONFIGURAZIONE PARETE CON SNODO 3 VIE E PORTE / WALL COMPOSITION WITH 3 WAYS JOIN AND DOORS

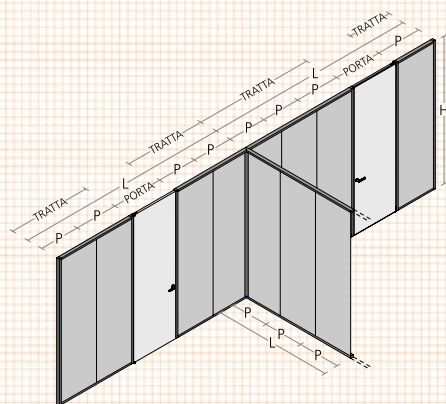

codice
code
SWPPS3VSW Anta battente / Swing door

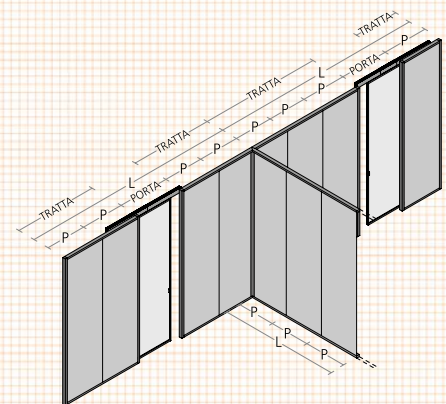

codice
code
SWPPS3VSL Anta scorrevole / Sliding door

CONFIGURAZIONE PARETE ANGOLARE CON PORTA / ANGULAR COMPOSITION WITH DOOR

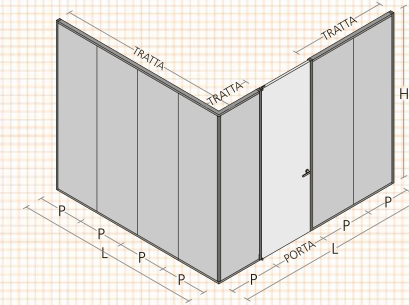

codice
code
SWPPASW Anta battente / Swing door

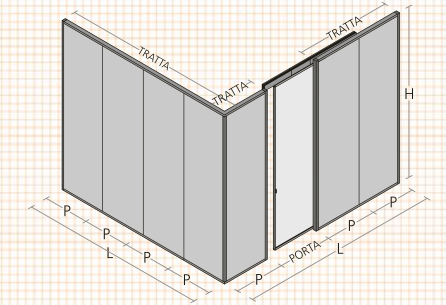

codice
code
SWPPASL Anta scorrevole / Sliding door

CONFIGURAZIONE PENISOLA CON PORTA / PENINSULA WALL COMPOSITION WITH DOOR

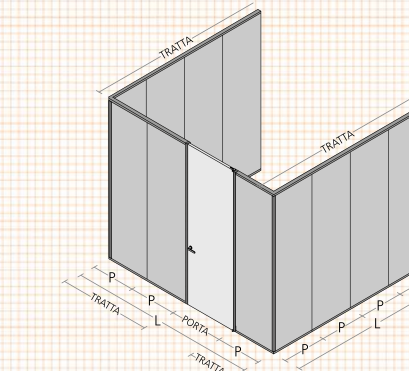

codice
code
SWPPSW Anta battente / Swing door

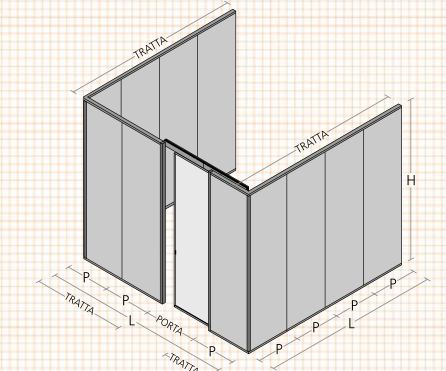

codice
code
SWPPSL Anta scorrevole / Sliding door

CONFIGURAZIONE ISOLA CON PORTA / ISLAND FREE STANDING WALL COMPOSITION WITH DOOR

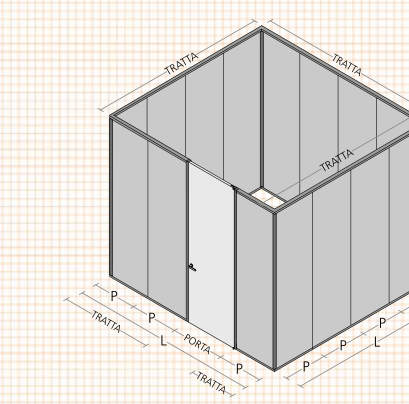

codice
code
SWIPSW Anta battente / Swing door

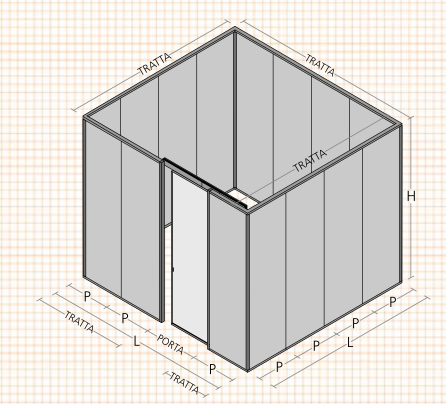

codice
code
SWIPSL Anta scorrevole / Sliding door

IT

Aladin Wall Mono è una parete divisoria, terra-soffitto, con un vetro stratificato mm 5+5 (o mm 4+6) applicato su un lato dei profili d'alluminio, fissati a pavimento, soffitto e parete, in modo da presentare una faccia con superficie planare e l'altra con superficie arretrata rispetto ai profili stessi. La struttura d'alluminio, disponibile in cinque diverse finiture, prevede un sistema di regolazioni per mettere la parete in bolla e compensare le irregolarità degli ambienti. Nella parete sono integrabili tutti i modelli di porte a battente e scorrevoli Glas Italia, coordinate nelle stesse finiture o con finiture diverse. (Attenzione: non tutte le tipologie di vetro utilizzabili nella parete sono disponibili in ogni modello di porta). Il vetro, disponibile in una vastissima gamma di finiture, è certificato secondo le normative di sicurezza ANSI Z97.1 e UNI EN12150. Sono disponibili anche pannelli in gres in diverse finiture.

REGOLAZIONE DELLA PARETE

- Soffitto 8 mm.
- Pavimento 12 mm.

EN

Aladin Wall Mono is a wall partition, floor-ceiling, with laminated glass 5+5 mm thick (or 4+6 mm thick) applied on one side of the aluminum profiles, fixed to floor, ceiling and/or wall, so that one side has a flush surface and the other is rebated from the profiles themselves. The aluminum structure, available in 5 different finishes, is supplied with an adjustment system to level the wall partition and to compensate irregularities in the floor or ceiling. The wall partition can be integrated with all the Glas Italia models of swing and sliding doors, and in the same or different finishes. (Note: not all glass finishes usable for the wall partition is available with every door model). The glass, available in a wide range of finishes, is certified in compliance with the safety regulation ANSI Z97.1 and UNI EN12150. The panels are also available in stoneware in many different finishes.

WALL ADJUSTMENT

- Ceiling: 8 mm.
- Floor: 12 mm.

FR

Aladin Wall Mono est une cloison sol-plafond avec un verre stratifié de 5+5 mm d'épaisseur (4+6 mm) appliqué sur un côté des profils en aluminium fixés au sol, au plafond et au mur, de manière à présenter une face avec une surface plane et l'autre avec une surface en retrait par rapport aux profils eux-mêmes. La structure en aluminium, disponible en cinq finitions différentes, à un système de réglages permettant de niveler la paroi et de compenser les irrégularités de l'espace. Tous les modèles de portes battantes et coulissantes Glas Italia peuvent être intégrés avec cette paroi, coordonnés dans les mêmes finitions ou avec des finitions différentes. (Attention: toutes les typologies de verre utilisables pour la paroi ne sont pas utilisables avec chaque modèle de porte). Les verres, disponibles dans une vaste gamme de finitions, sont certifiés selon les normes de sécurité ANSI Z97.1 et UNI EN12150. Panneaux en grès en différentes finitions sont également disponibles.

RÉGLAGE DE LA CLOISON

- Plafond: 8 mm.
- Sol: 12 mm.

**DE**

Aladin Wall Mono ist eine Boden-Decke Trennwand aus 5+5 mm (oder 4+6) stark beschichtetem Glas, das einseitig in den umlaufenden Aluminiumrahmen verklebt ist. Die Aluminiumrahmen werden am Boden, an der Decke und an der Wand befestigt, so dass eine Seite bündig mit der Rahmen abschließt und auf der Gegenseite zurückspringt. Die Aluminiumstruktur, erhältlich in fünf verschiedenen Ausführungen, wird mit einem Anpassungssystem geliefert, um die Trennwand zu nivellieren und die Unregelmäßigkeiten des Raumes auszugleichen. Die Trennwände sind kombinierbar mit allen Glas Italia Modellen von Dreh- und Schiebetüren und können in den gleichen oder verschiedenen Ausführungen abgestimmt werden. (Achtung: nicht alle Glastypologien, die für die Trennwände verfügbar sind, können für jedes Türmodell verwendet sein). Das Glas ist in zahlreichen Ausführungen erhältlich und ist gemäß ANSI Z97.1 und UNI EN12150 zertifiziert. Feinsteinzeug-Paneele in verschiedenen Ausführungen sind ebenfalls erhältlich.

TRENNWANDJUSTIERUNG

- Decke: 8 mm.
- Boden: 12 mm.

ES

Aladin Wall Mono es una pared divisoria, suelo-techo, con un cristal estratificado 5+5 mm (o 4+6 mm) aplicado en un lado de los perfiles de aluminio fijados a suelo, techo y pared, con el fin de tener una cara con una superficie coplanar y la otra con superficie retraída respecto a los perfiles. La estructura de aluminio, disponible en cinco acabados diferentes, tiene un sistema de regulaciones para permitir posicionar la pared a nivel y compensar las irregularidades de las habitaciones. En las paredes se pueden integrar todos los modelos de puertas batientes y correderas Glas Italia, coordinadas en los mismos acabados o con acabados diferentes. (Atención: no todos los tipos de cristal que se pueden utilizar en las paredes están disponibles en cada modelo de puerta). El cristal, disponible en una amplia gama de acabados, está certificado según las normativas de seguridad ANSI Z97.1 y UNI EN12150. Están disponibles también paneles de gres con diferentes acabados.

REGULACIÓN PARED

- Techo: 8 mm.
- Suelo: 12 mm.

Aladin Wall Mono

PANNELLI ALADIN WALL MONO / ALADIN WALL MONO PANELS

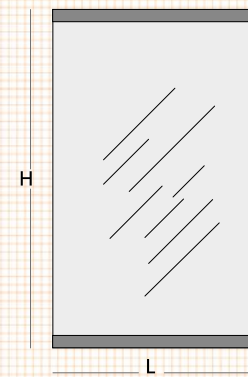

PROFILO VERTICALE CONTRO MURO / WALL MOUNTED PROFILE

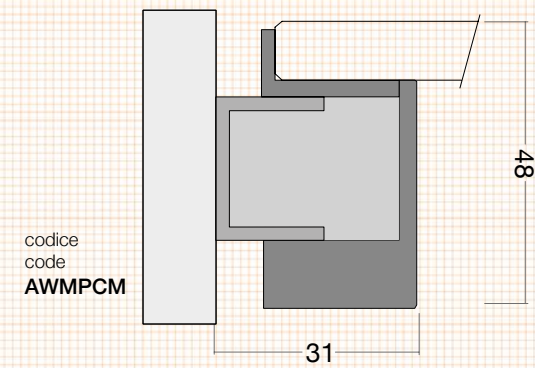

PROFILO VERTICALE CENTRO STANZA / CENTRAL VERTICAL PROFILE

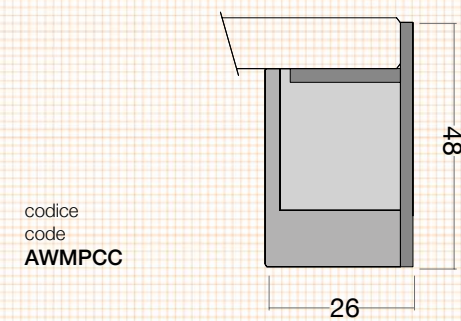

PROFILO PER PORTA BATTENTE / SWING DOOR PROFILE

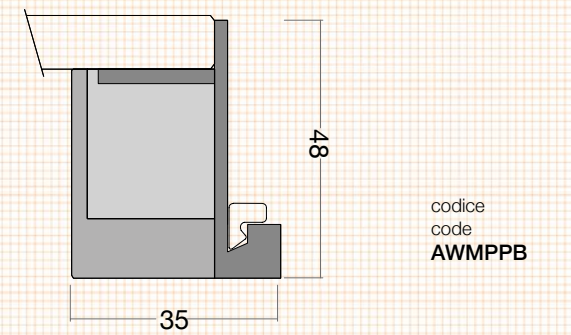

PROFILO PER PORTA BATTENTE POSIZIONATA A MURO / PROFILE FOR SWING DOOR PLACED AGAINST THE WALL

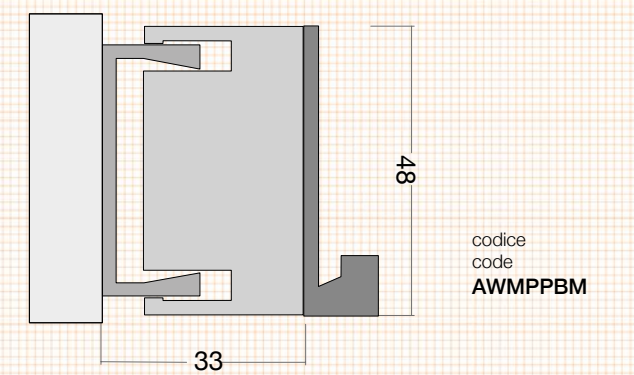

PROFILO VERTICALE PER ABBASSAMENTO / WALL MOUNTED PROFILE FOR DROP CEILING

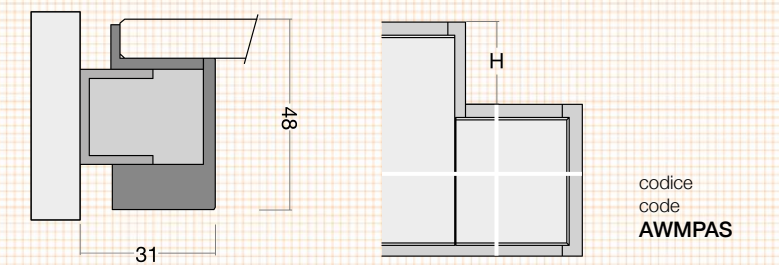

Aladin Wall Mono

GIUNZIONE IN LINEA / ALIGNED JOINT

codice
code
AWMGL
altezza (mm) fino a /
height (mm) up to
H 3050

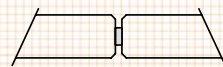

ANGOLO A 90 GRADI / 90 DEGREE ANGLE

codice
code
AWM90
altezza (mm) fino a /
height (mm) up to
H 3050

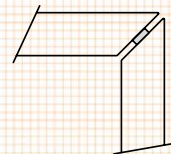

ANGOLO A GRADI VARIABILI CON BIADESIVO /
VARIABLE DEGREES ANGLE

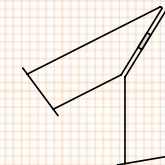
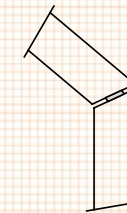

codice
code
AWMGV
altezza (mm) fino a /
height (mm) up to
H 3050

SNODO 3 VIE / 3 WAYS JOINT

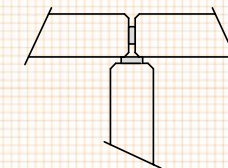

codice
code
AWM3V
altezza (mm) fino a /
height (mm) up to
H 3050

SNODO A 3 VIE AD ANGOLI VARIABILI CON BIADESIVO /
VARIABLE ANGLES 3 WAYS JOINT

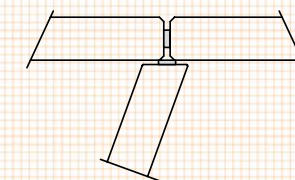
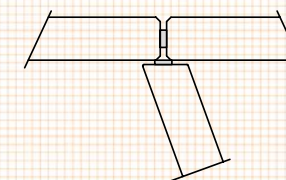

codice
code
AWM3V
altezza (mm) fino a /
height (mm) up to
H 3050

Aladin Wall Mono

CONFIGURAZIONE PARETE LINEARE CON PORTA / LINEAR WALL CONFIGURATION WITH DOOR

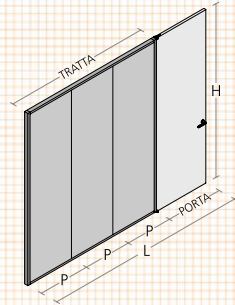

codice
code
AWPLSWM Anta battente / Swing door

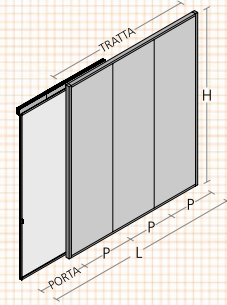

codice
code
AWPLSLM Anta scorrevole / Sliding door

CONFIGURAZIONE PARETE LINEARE CON PORTA / LINEAR WALL CONFIGURATION WITH DOOR

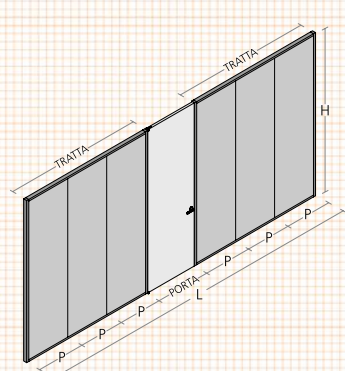

codice
code
AWPLSWM Anta battente / Swing door

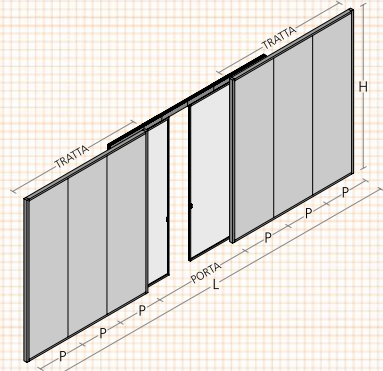

codice
code
AWPLSLM Anta scorrevole / Sliding door

CONFIGURAZIONE PARETE CON SNODO 3 VIE E PORTE / WALL COMPOSITION WITH 3 WAYS JOIN AND DOORS

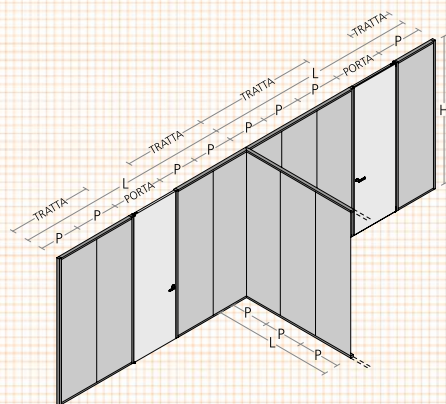

codice
code
AWPS3VSWM Anta battente / Swing door

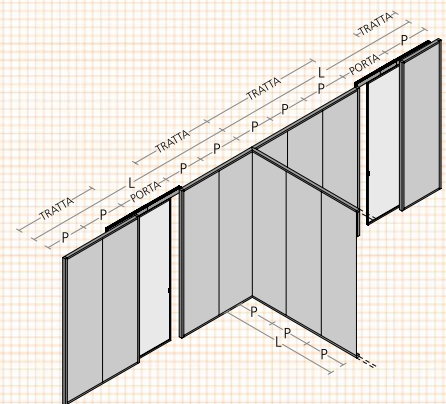

codice
code
AWPS3VSLM Anta scorrevole / Sliding door

CONFIGURAZIONE PARETE ANGOLARE CON PORTA / ANGULAR COMPOSITION WITH DOOR

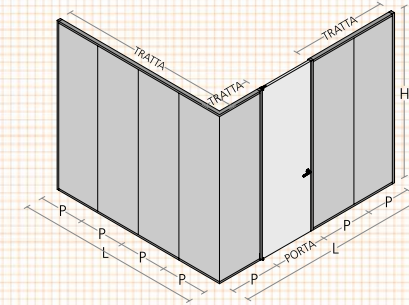

codice
code
AWPASWM Anta battente / Swing door

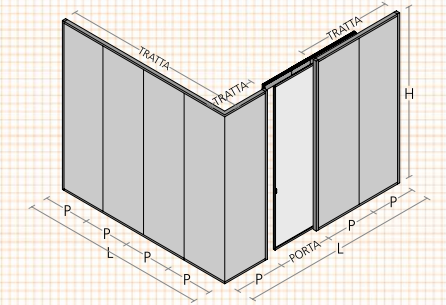

codice
code
AWPASLM Anta scorrevole / Sliding door

CONFIGURAZIONE PENISOLA CON PORTA / PENINSULA WALL COMPOSITION WITH DOOR

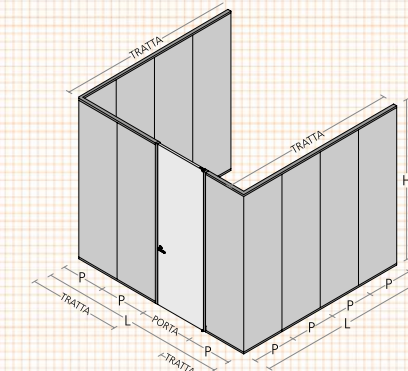

codice
code
AWPSWM Anta battente / Swing door

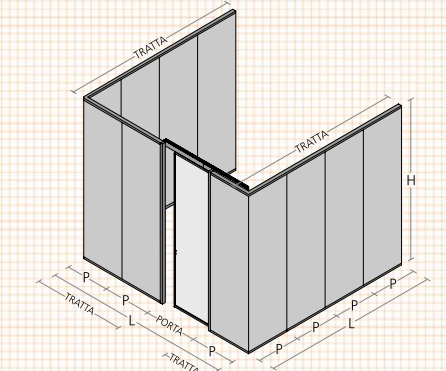

codice
code
AWPSLM Anta scorrevole / Sliding door

CONFIGURAZIONE ISOLA CON PORTA / ISLAND FREE STANDING WALL COMPOSITION WITH DOOR

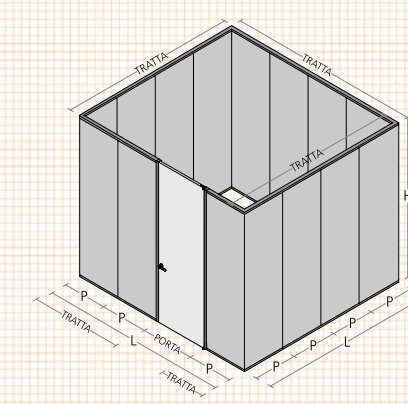

codice
code
AWISWM Anta battente / Swing door

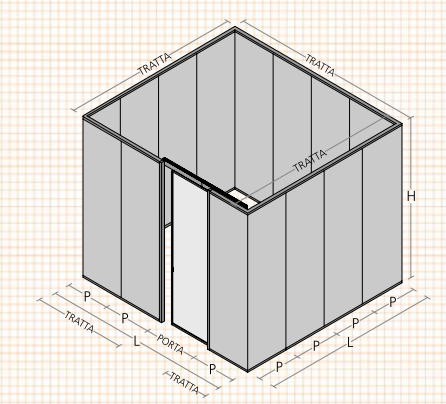

codice
code
AWISLM Anta scorrevole / Sliding door

IT

Aladin Wall Duo è una parete divisoria, terra-soffitto, con doppio vetro stratificato mm. 5+5 (o mm 4+6) applicato su entrambi i lati dei profili d'alluminio fissati a pavimento, soffitto e parete, in modo da formare una camera d'aria interna e avere superfici perfettamente planari sulle due facce della parete. La struttura d'alluminio, disponibile in cinque diverse finiture, prevede un sistema di regolazioni per mettere la parete in bolla e compensare le irregolarità degli ambienti. Nella parete sono integrabili tutti i modelli di porte a battente e scorrevoli Glas Italia, coordinate nelle stesse finiture o con finiture diverse (attenzione: non tutte le tipologie di vetro utilizzabili nella parete sono disponibili in ogni modello di porta). Il vetro, disponibile in una vastissima gamma di finiture, è certificato secondo le normative di sicurezza ANSI Z97.1 e UNI EN12150. Sono disponibili anche pannelli in gres in diverse finiture.

REGOLAZIONE DELLA PARETE

- Soffitto 8 mm.
- Pavimento 12 mm.

EN

Aladin Wall Duo is a wall partition, floor-ceiling, with double laminated glass 5+5 mm. (or 4+6 mm) applied on both sides of the aluminum profiles, fixed to floor, ceiling and wall, so as to form an internal air chamber and have surfaces perfectly flush on both sides of the wall. The aluminum structure, available in 5 different finishes, is supplied with an adjustment system to level the wall and to compensate irregularities in the floor or ceiling. The wall partition can be integrated with all the Glas Italia models of swing and sliding doors, and in the same or different finishes. (Note: not all glass finishes usable for the wall partition is available with every door model). The glass, available in a wide range of finishes, is certified in compliance with the safety regulation ANSI Z97.1 and UNI EN12150. The panels are also available in stoneware in many different finishes.

WALL ADJUSTMENT

- Ceiling: 8 mm.
- Floor: 12 mm.

FR

Aladin Wall Duo est une cloison sol-plafond avec double verre stratifié de 5+5 mm d'épaisseur (ou 4 6 mm) appliqués sur les deux côtés des profils en aluminium fixés au sol, au plafond et au mur, de manière à former un volume d'air intérieur et avoir des surfaces parfaitement planes sur les deux faces de la paroi. La structure en aluminium, disponible en cinq finitions différentes, a un système de réglages permettant de niveler le mur et de compenser les irrégularités de l'espace. Tous les modèles de portes battantes et coulissantes Glas Italia peuvent être intégrés dans cette paroi, coordonnés dans les mêmes finitions ou avec des finitions différentes. (Attention: toutes les typologies de verre utilisables pour la paroi ne sont pas utilisables avec chaque modèle de porte). Les verres, disponibles dans une vaste gamme de finitions, sont certifiés selon les normes de sécurité ANSI Z97.1 et UNI EN12150. Panneaux en grès en différents finitions sont également disponibles.

RÉGLAGE DE LA CLOISON

- Plafond: 8 mm.
- Sol: 12 mm.



DE

Aladin Wall Duo ist eine Boden-Decke Trennwand aus 5+5 mm (oder 4+6) stark beschichtetem Glas, das beidseitig in den umlaufenden Aluminiumrahmen verklebt ist. Die Aluminiumrahmen werden am Boden, an der Decke und an der Wand befestigt, so dass zwischen den Füllungen einen Luftraum besteht und beide Seite bündig mit der Wand abschließen. Die Aluminiumstruktur, erhältlich in fünf verschiedenen Ausführungen, wird mit einem Anpassungssystem geliefert, um die Trennwand zu nivellieren und die Unregelmäßigkeiten des Raumes auszugleichen. Die Trennwände sind kombinierbar mit allen Glas Italia Modellen von Dreh- und Schiebetüren und können in den gleichen oder verschiedenen Ausführungen abgestimmt werden. (Achtung: nicht alle Glastypologien, die für die Trennwände verfügbar sind, können für jedes Türmodell verwendet sein). Das Glas ist in zahlreichen Ausführungen erhältlich und ist gemäß ANSI Z97.1 und UNI EN12150 zertifiziert. Feinsteinzeug-Paneele in verschiedenen Ausführungen sind ebenfalls erhältlich.

TRENNWANDJUSTIERUNG

- Decke: 8 mm.
- Boden: 12 mm.

ES

Aladin Wall Duo es una pared divisoria, suelo-techo, con cristal doble estratificado 5+5 mm (o 4+6 mm) aplicado en ambos lados de los perfiles de aluminio fijados a suelo, techo y pared, con el fin de crear una cámara de aire interna y tener superficies perfectamente planas en los dos lados de la pared. La estructura de aluminio, disponible en cinco acabados diferentes, tiene un sistema de regulación para permitir posicionar la pared a nivel y compensar las irregularidades de las habitaciones. En las paredes se pueden integrar todos los modelos de puertas batientes y correderas Glas Italia, coordinadas en los mismos acabados o con acabados diferentes (atención: no todos los tipos de cristal que se pueden utilizar en las paredes están disponibles en cada modelo de puerta). El cristal, disponible en una amplia gama de acabados, está certificado según las normativas de seguridad ANSI Z97.1 y UNI EN12150. Están disponibles también paneles de gres con diferentes acabados.

REGULACIÓN PARED

- Techo: 8 mm.
- Suelo: 12 mm.

Aladin Wall Duo

PANNELLI ALADIN WALL DUO / ALADIN WALL DUO PANELS

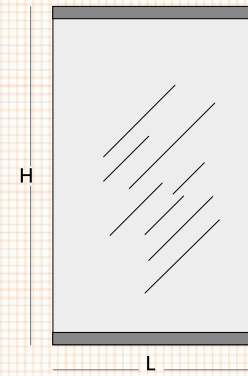

PROFILO VERTICALE CONTRO MURO / WALL MOUNTED PROFILE

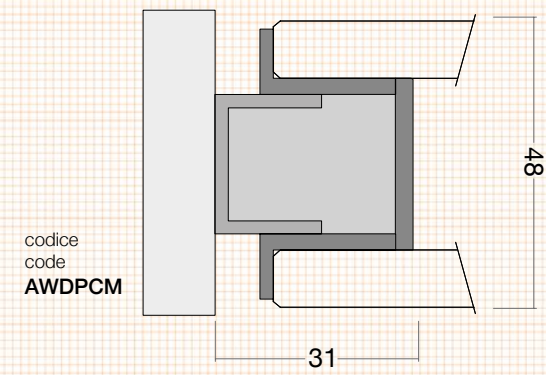

PROFILO VERTICALE CENTRO STANZA / CENTRAL VERTICAL PROFILE

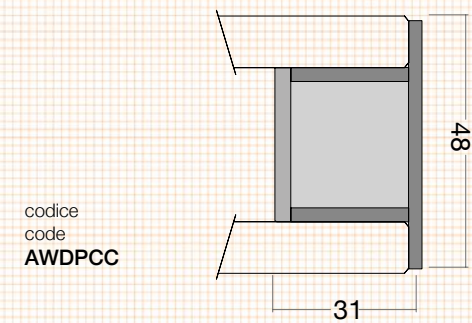

PROFILO PER PORTA BATTENTE / SWING DOOR PROFILE

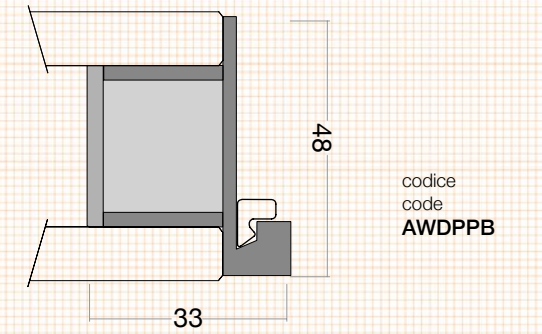

PROFILO PER PORTA BATTENTE POSIZIONATA A MURO / PROFILE FOR SWING DOOR PLACED AGAINST THE WALL

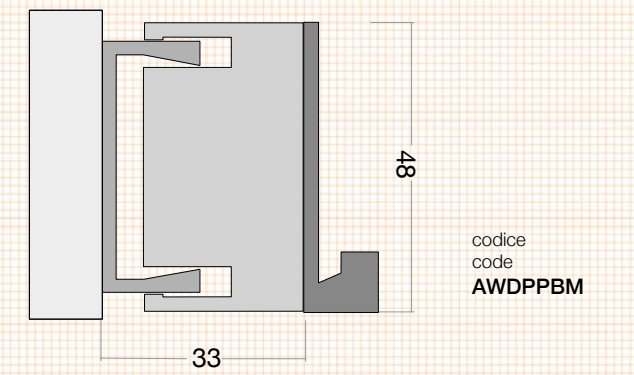

PROFILO VERTICALE PER ABBASSAMENTO / WALL MOUNTED PROFILE FOR DROP CEILING

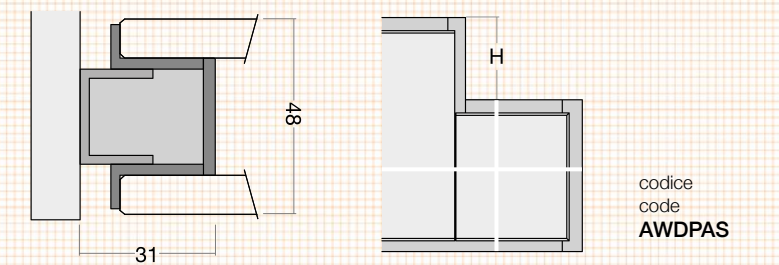

Aladin Wall Duo

GIUNZIONE IN LINEA / ALIGNED JOINT

codice
code
AWDGL

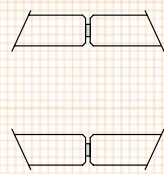

ANGOLO A 90 GRADI / 90 DEGREE ANGLE

codice
code
AWD90

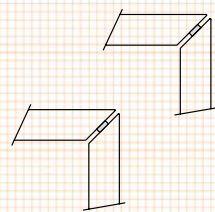

ANGOLO A GRADI VARIABILI CON BIADESIVO /
VARIABLE DEGREES ANGLE

codice
code
AWDGV

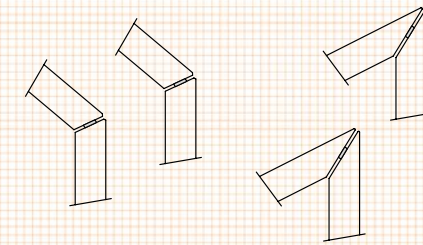

SNODO 3 VIE / 3 WAYS JOINT

codice
code
AWD3V

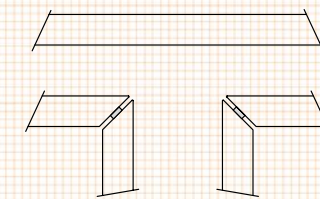

SNODO A 3 VIE AD ANGOLI VARIABILI CON BIADESIVO /
VARIABLE ANGLES 3 WAYS JOINT

codice
code
AWD3VV

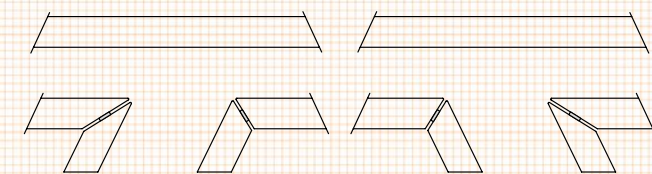

Aladin Wall Duo

CONFIGURAZIONE PARETE LINEARE CON PORTA / LINEAR WALL CONFIGURATION WITH DOOR

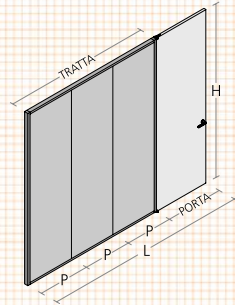

codice
code
AWPLSWD Anta battente / Swing door

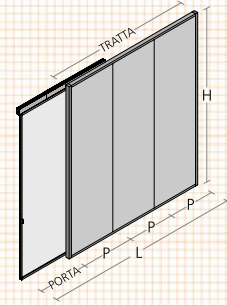

codice
code
AWPLSLD Anta scorrevole / Sliding door

CONFIGURAZIONE PARETE LINEARE CON PORTA / LINEAR WALL CONFIGURATION WITH DOOR

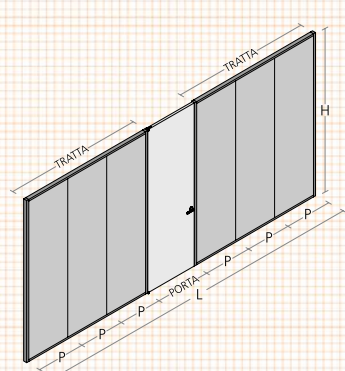

codice
code
AWPLSWD Anta battente / Swing door

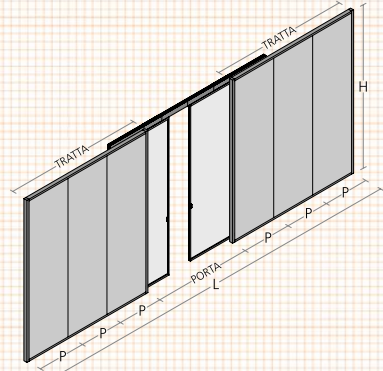

codice
code
AWPLSLD Anta scorrevole / Sliding door

CONFIGURAZIONE PARETE CON SNODO 3 VIE E PORTE / WALL COMPOSITION WITH 3 WAYS JOIN AND DOORS

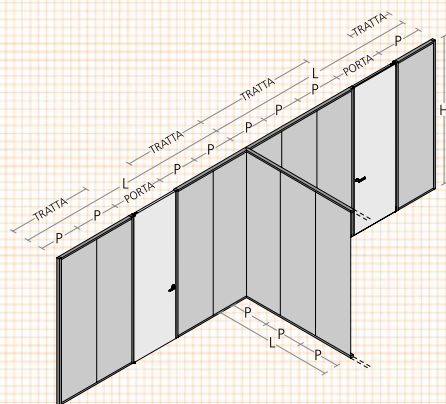

codice
code
AWPS3VSWD Anta battente / Swing door

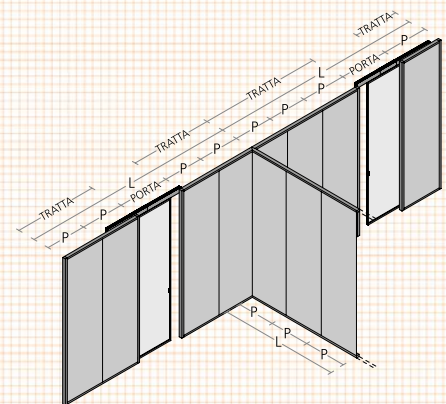

codice
code
AWPS3VSLD Anta scorrevole / Sliding door

CONFIGURAZIONE PARETE ANGOLARE CON PORTA / ANGULAR COMPOSITION WITH DOOR

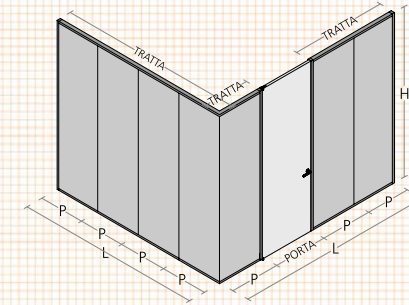

codice
code
AWPASWD Anta battente / Swing door

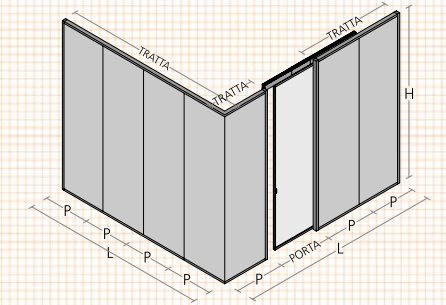

codice
code
AWPASLD Anta scorrevole / Sliding door

CONFIGURAZIONE PENISOLA CON PORTA / PENINSULA WALL COMPOSITION WITH DOOR

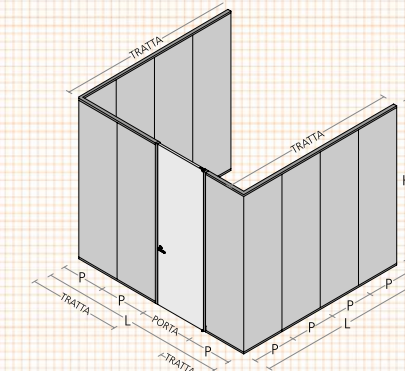

codice
code
AWPSWD Anta battente / Swing door

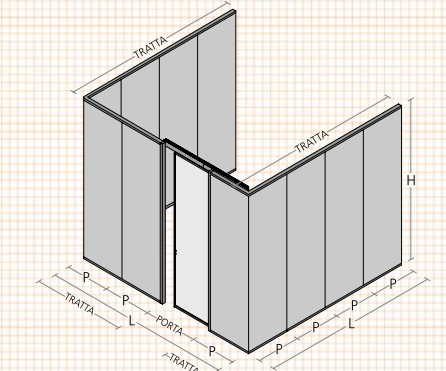

codice
code
AWPSLD Anta scorrevole / Sliding door

CONFIGURAZIONE ISOLA CON PORTA / ISLAND FREE STANDING WALL COMPOSITION WITH DOOR

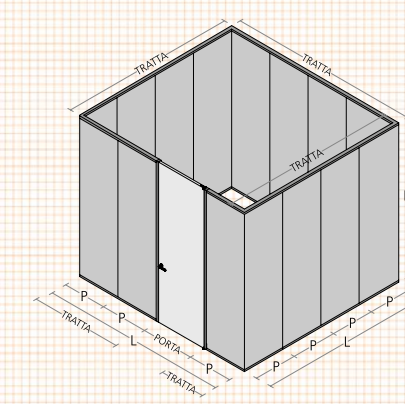

codice
code
AWISWD Anta battente / Swing door

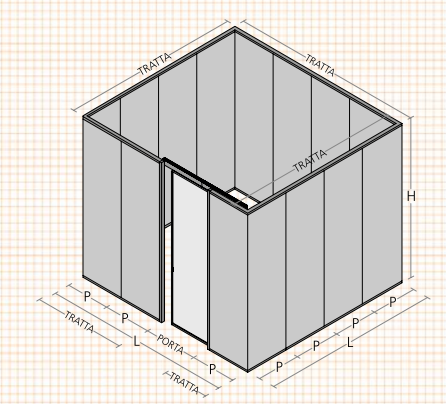

codice
code
AWISLD Anta scorrevole / Sliding door

IT

Sherazade Spin è un pannello con movimento rotatorio a bilico verticale, con cerniere a perno regolabili, che si presta a numerose soluzioni progettuali.

L'anta, priva di battuta, ha sempre un'apertura bidirezionale ed è disponibile con perno centrale o decentrato. La versione con perno centrale ha una rotazione di 360 gradi. Affiancando due o più pannelli, si possono configurare partizioni apribili parzialmente o totalmente. Il perfetto allineamento dei pannelli è garantito da un sistema magnetico (non è prevista una chiusura idraulica). Un vetro monolitico temperato da 6 mm o stratificato 3+3 mm è inserito tramite una guarnizione al centro di un telaio d'alluminio, fornito in cinque diverse finiture.

I vetri, disponibili in una vastissima gamma di finiture, sono certificati secondo le normative di sicurezza ANSI Z97.1 e UNI EN12150. Sono disponibili anche pannelli in gres o in legno con diverse finiture ed essenze.

Il corpo della cerniera superiore è alloggiato all'interno di un profilo d'alluminio da inserire a filo del controsoffitto e verniciare con la pitturazione dello stesso.



EN

Sherazade Spin is a panel with a vertical pivoting revolving movement, with adjustable pivot hinges, which lends itself to numerous design solutions.

The door WITH NO STOP always has a bidirectional opening and is available with a central or offset pivot. The version with central pivot has a rotation of 360 degrees. By placing two or more panels side by side, you can configure partially or totally openable partitions. The perfect alignment of the panels is guaranteed by a magnetic system (there is no hydraulic closure). A 6 mm tempered monolithic glass or 3 + 3 mm laminated glass is inserted through a gasket in the center of an aluminum frame, supplied in five different finishes.

The glass, available in a wide range of finishes, is certified according to the ANSI Z97.1 and UNI EN12150 safety. Ceramic or wooden panels with different finishes and veneers are also available.

The body of the upper hinge is housed inside an aluminium profile, to be inserted flush with the false ceiling and painted as per the wall finish.

FR

Sherazade Spin est un panneau avec un mouvement de rotation vertical pivotant, avec des charnières pivotantes ajustables, qui se prête à de nombreuses solutions de design.

La porte sans butée a toujours une ouverture bidirectionnelle et est disponible avec un pivot central ou décentralisé.

La version avec pivot central a une rotation de 360 degrés. En plaçant deux ou plusieurs panneaux côte à côte, on peut configurer des partitions partiellement ou totalement ouvrables. L'alignement parfait des panneaux est garanti par un système magnétique (il n'y a pas de fermeture hydraulique). Un verre monolithique trempé de 6 mm ou un verre stratifié de 3 + 3 mm est inséré par un joint au milieu d'un cadre en aluminium, disponible en cinq finitions différentes. Les verres, disponibles dans une large gamme de finitions, sont certifiés selon les normes de sécurité ANSI Z97.1 et UNI EN12150. Des panneaux en grès ou en bois avec différentes finitions et essences sont également disponibles. Le corps de la charnière supérieure est logé dans un profil en aluminium à insérer au fil du faux plafond et peint avec la peinture correspondante.

DE

Sherazade Spin ist ein vertikal drehbares Paneel, das mittels eines Stiftes und verstellbaren Zapfenschäbnerie zwischen Boden und Decke verspannt wird und geeignet für zahlreiche Designlösungen ist. Die Tür, ohne Anschlag, kann beidseitig geöffnet werden. Die Montage des Stiftes ist zentral oder dezentral möglich. Die Version mit zentralem Stift ist um 360 Grad drehbar. Die Version mit Mittelstift ist um 360 Grad drehbar.

Indem Sie zwei oder mehrere Paneele nebeneinanderstellen, können Sie Raumteiler gestalten, die man komplett oder partiell öffnen kann. Die perfekte Ausrichtung der Paneele wird durch ein Magnetsystem gewährleistet (Kein hydraulischer Verschluss ist vorgesehen). Das Glas kann 6 mm. stark monolithisch gehärtet oder 3+3 mm. stark beschichtet sein. Es ist mittels einer Dichtung in dem Aluminiumrahmen eingesetzt, der in fünf verschiedenen Ausführungen erhältlich ist. Die Gläser sind in einer sehr weiten Serie von Ausführungen verfügbar und sind gemäß ANSI Z97.1 und UNI EN12150 zertifiziert. Gres- und Holzpaneele in verschiedenen Ausführungen und Hölzern sind ebenfalls erhältlich.

Das nicht verblendbare Deckenprofil aus Aluminium wird bündig in einer Zwischendecke montiert und in der gleichen Deckenfarbe angestrichen.

ES

Sherazade Spin es un panel con movimiento de rotación a pivotante vertical, con bisagras a perno ajustable, que se presta a numerosas soluciones de proyectos. La puerta, sin renvalso, tiene siempre una apertura bidireccional y está disponible con perno central o descentrado. La versión con perno central tiene una rotación de 360°.

Flanqueando dos o más paneles, se pueden configurar particiones que se abren parcialmente o totalmente.

La perfecta alineación de los paneles está garantizada por un sistema magnético (no hay cierre hidráulico).

Un cristal monolitico templado de 6 mm o estratificado 3+3 mm, se inserta por medio de una junta en el marco de aluminio, suministrado en cinco acabados diferentes. Los cristales son certificados según las normativas de seguridad ANSI Z97.1 y UNI EN12150. Están disponibles también en paneles de gres o de madera con diferentes acabados. El cuerpo de la bisagra superior está en el interior de un perfil de luminio, para insertar al falso techo y barnizar con la pintura del mismo.

Sherazade Spin

Design Piero Lissoni

ANTA SPIN / SPIN DOOR

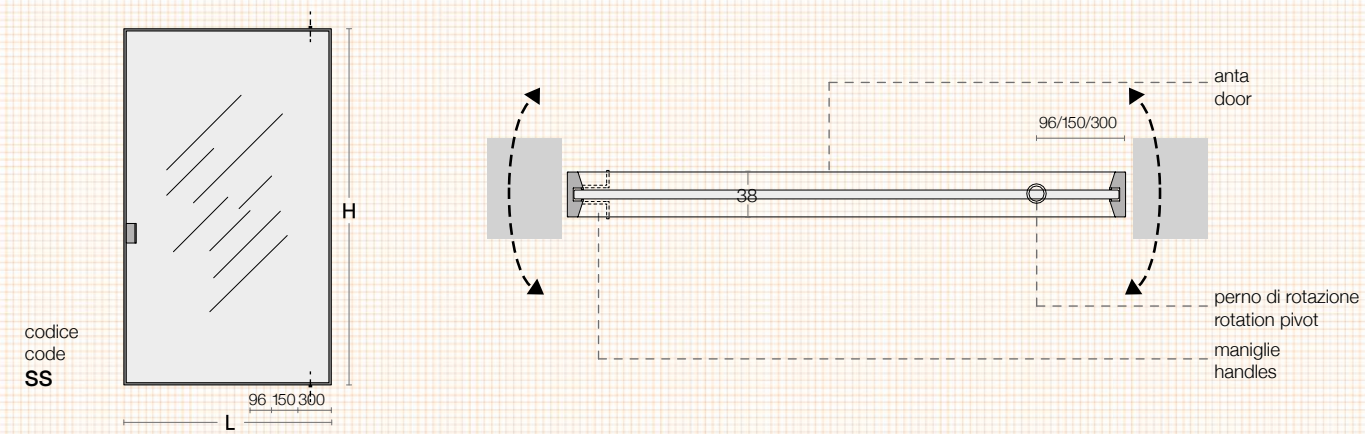
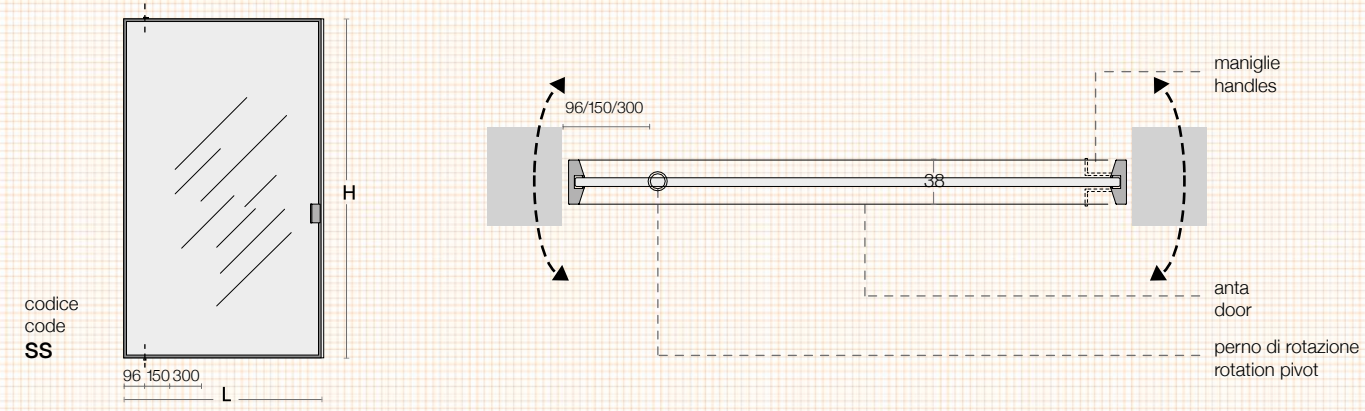
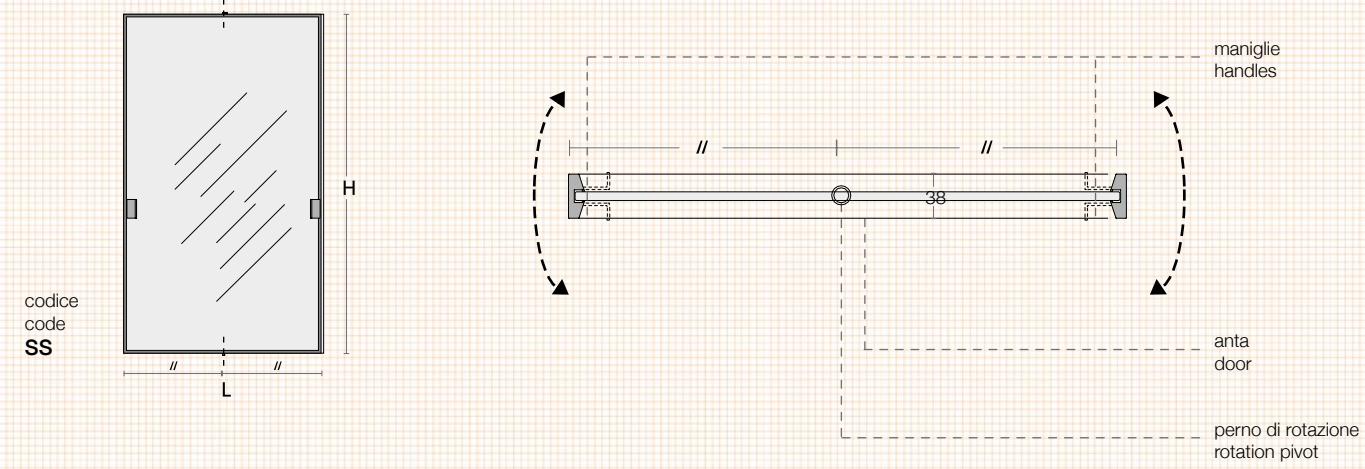

MANIGLIE SHERAZADE SPIN / HANDLES SHERAZADE SPIN

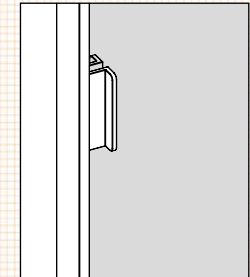

maniglia senza supporto /
handle without support

codice / code :
MSSS

IT

Sherazade Spin Patchwork è un pannello con movimento rotatorio a bilico verticale, con cerniere a perno regolabili, che si presta a numerose soluzioni progettuali.

L'anta, priva di battuta, ha sempre un'apertura bidirezionale ed è disponibile con perno centrale o decentrato. La versione con perno centrale ha una rotazione di 360 gradi. Affiancando due o più pannelli, si possono configurare partizioni apribili parzialmente o totalmente. Il perfetto allineamento dei pannelli è garantito da un sistema magnetico (non è prevista una chiusura idraulica). La superficie dell'anta è ripartita in quattro riquadri, in cui possono essere posizionati diversi tipi di cristalli temperati monolitici 6 mm o stratificati 3+3 mm.

Questi pannelli, tramite una guarnizione, vengono inseriti al centro di profili d'alluminio, forniti in cinque diverse finiture.

I vetri, disponibili in una vastissima gamma di finiture, sono certificati secondo le normative di sicurezza ANSI Z97.1 e UNI EN12150 (ad eccezione di 533. retinato). Il corpo della cerniera superiore è alloggiato all'interno di un profilo d'alluminio da inserire a filo del controsoffitto e verniciare con la pitturazione dello stesso.



EN

Sherazade Spin Patchwork is a panel with a vertical pivoting rotary movement, with adjustable pivot hinges, which lends itself to numerous design solutions.

The door with no stop always has a bidirectional opening and is available with a central or offset pivot. The version with central pivot has a rotation of 360 degrees. By placing two or more panels side by side, you can configure partially or totally openable partitions. The perfect alignment of the panels is guaranteed by a magnetic system (there is no hydraulic closure). The surface of the door is divided into four panels, into which different types of 6 mm monolithic or stratified 3 + 3 mm tempered glass can be positioned. These panels are inserted through a gasket in the center of aluminum profiles, supplied in five different finishes. The glass, available in a wide range of finishes, is certified according to the ANSI Z97.1 and UNI EN12150 safety standards (except for 533. Retinato). Ceramic or wooden panels with different finishes and veneers are also available. The body of the upper hinge is housed inside an aluminum profile, to be inserted flush with the false ceiling and painted as per the wall finish.

FR

Sherazade Spin Patchwork est un panneau avec un mouvement de rotation vertical, avec des charnières à pivot ajustables, qui se prête à de nombreuses solutions de design.

La porte sans butée a toujours une ouverture bidirectionnelle et elle est disponible avec un pivot central ou décentralisé. La version avec pivot central a une rotation de 360 degrés. En plaçant deux ou plusieurs panneaux côte à côte, on peut configurer des partitions partiellement ou totalement ouvrables. L'alignement parfait des panneaux est garanti par un système magnétique (il n'y a pas de fermeture hydraulique). La surface de la porte est divisée en quatre panneaux dans lesquels différents types de verre trempé monolithique de 6 mm ou stratifié de 3 + 3 mm peuvent être positionnés. Ces panneaux, à l'aide d'un joint, sont insérés au centre de profilés en aluminium, fournis en cinq finitions différentes. Les verres, disponibles dans une vaste gamme de finitions, sont certifiés selon les normes de sécurité ANSI Z97.1 et UNI EN12150 (à l'exception de la finition 533. retinato). Le corps de la charnière supérieure est logé dans un profil en aluminium à insérer au ras du faux plafond et peint avec la peinture correspondante.

DE

Sherazade Spin Patchwork ist ein vertikal drehbares Paneel, das mittels eines Stiftes und verstellbaren Zapfenschärniere zwischen Boden und Decke verspannt wird und geeignet für zahlreiche Designlösungen ist. Die Tür, ohne Anschlag, kann beidseitig geöffnet werden. Die Montage des Stiftes ist zentral oder dezentral möglich. Die Version mit zentralem Stift ist um 360 Grad drehbar. Die Version mit Mittelstift ist um 360 Grad drehbar. Indem Sie zwei oder mehrere Paneele nebeneinanderstellen, können Sie Raumteiler gestalten, die man partiell oder komplett öffnen kann. Die perfekte Ausrichtung der Paneele wird durch ein Magnetsystem gewährleistet (Kein hydraulischer Verschluss ist vorgesehen). Die Oberfläche ist auf vier Felder aufgeteilt, wo verschiedene Glastypologien von 6 mm starken monolithischen gehärteten Gläsern oder 3+3 mm. starken beschichteten Gläsern platziert werden können. Es ist mittels einer Dichtung in dem Aluminiumrahmen eingesetzt, der in fünf verschiedenen Ausführungen erhältlich ist. Die Gläser sind in einer sehr weiten Serie von Ausführungen verfügbar und sind gemäß ANSI Z97.1 und UNI EN12150 zertifiziert (außer für die Ausführung 533. Retinato). Das nicht verblendbare Deckenprofil aus Aluminium wird bündig in einer Zwischendecke montiert und in der gleichen Deckenfarbe angestrichen.

ES

Sherazade Spin Patchwork es un panel con movimiento de rotación a pivotante vertical, con bisagras a perno ajustable, que se presta a numerosas soluciones de proyectos.

La puerta, sin renvalso, tiene siempre una apertura bidireccional y está disponible con perno central o descentrado. La versión con perno central tiene una rotación de 360°. Flanqueando dos o más paneles, se pueden configurar particiones que se abren parcialmente o totalmente. La perfecta alineación de los paneles está garantizada por un sistema magnético (no hay cierre hidráulico). La superficie de la puerta está dividida en cuatro cuadrados, donde se pueden colocar diferentes tipos de cristales templados monolíticos de 6 mm o estratificado 3+3 mm.

Estos paneles, por medio de una junta, se insertan en el centro del marco de aluminio, suministrado en cinco acabados diferentes. Los cristales son certificados según las normativas de seguridad ANSI Z97.1 y UNI EN12150 (533. retinato excluido). Están disponibles también en paneles de gres o de madera con diferentes acabados.

El cuerpo de la bisagra superior está en el interior de un perfil de aluminio, para insertar en falso techo y barnizar con la pintura del mismo.

Sherazade Spin Patchwork

Design Piero Lissoni

APERTURA PORTA SPIN / OPENING SPIN DOOR

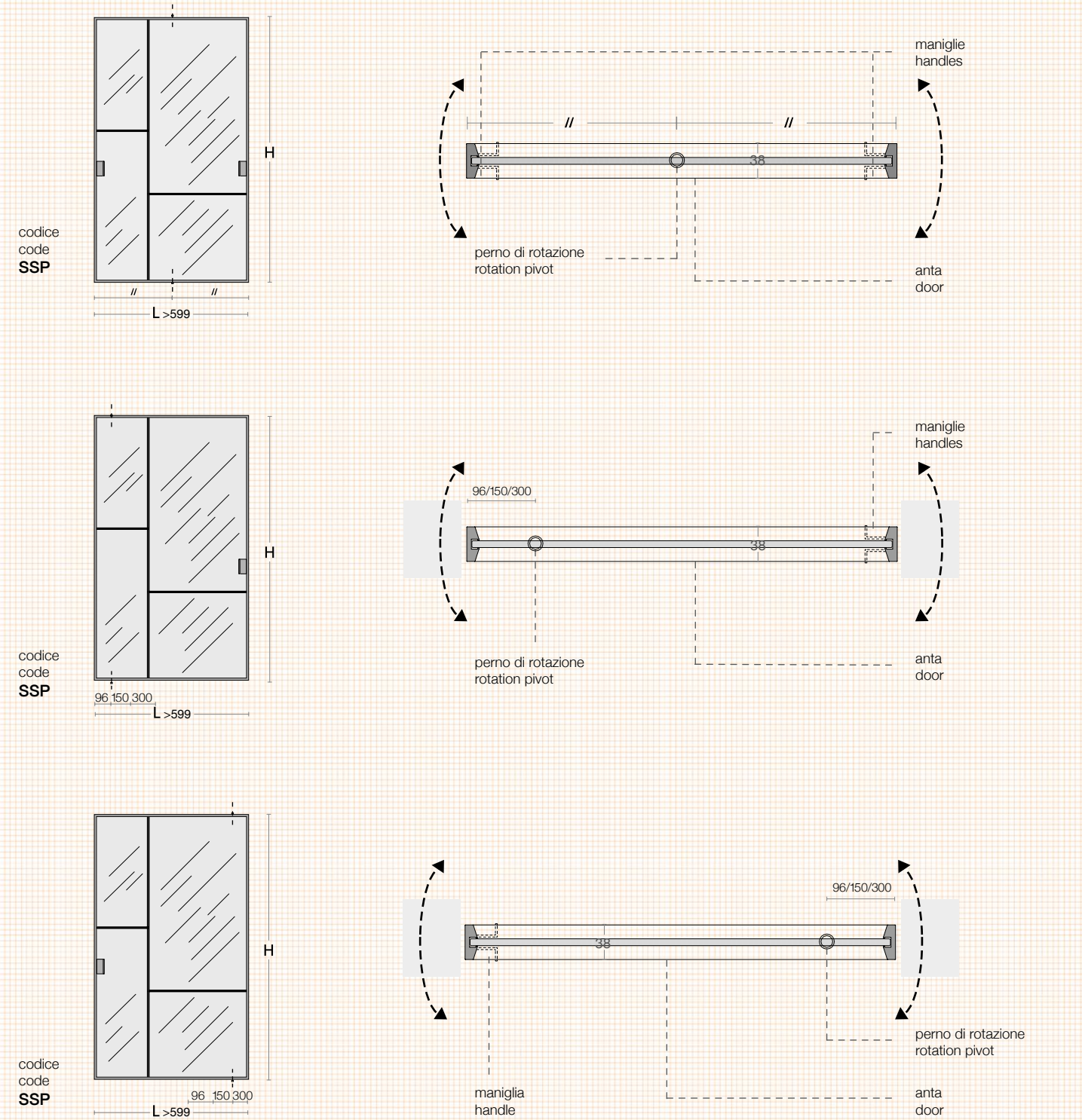

CONFIGURAZIONE PORTA SPIN / CONFIGURATION SPIN DOOR

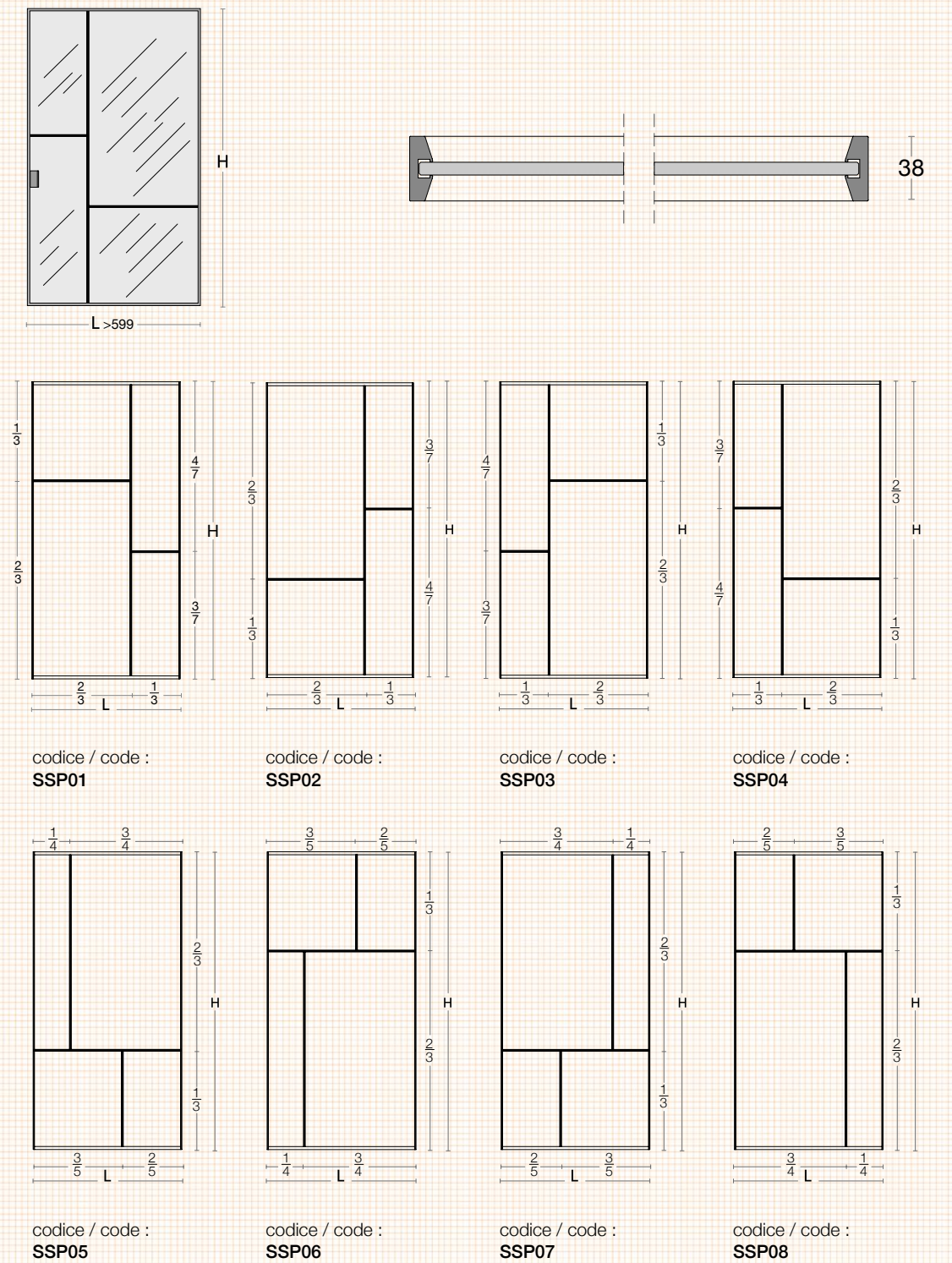

Sherazade Spin Patchwork

Design Piero Lissoni

IPOTESI PROGETTUALI / PROJECTS CONFIGURATION

codice
code
SSP

asse parete / wall axis



porte chiuse / door closed

asse parete / wall axis

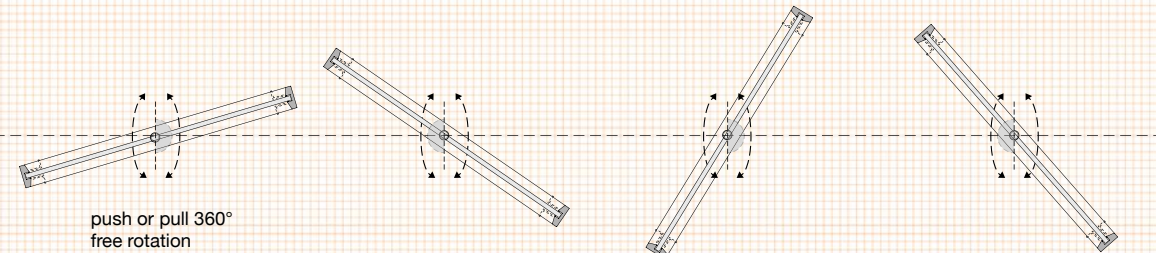

porte aperte / door open

push or pull 360°
free rotation

codice
code
SSP

asse parete / wall axis



porte chiuse / door closed

asse parete / wall axis



porte aperte / door open

push or pull 180°
free rotation

MANIGLIE SHERAZADE SPIN / HANDLES SHERAZADE SPIN

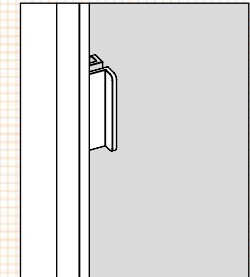

maniglia senza supporto /
handle without support

codice / code :
MSSS

IT

Aladin Spin Mono è un pannello con movimento rotatorio a bilico verticale, con cerniere a perno regolabili, che si presta a numerose soluzioni progettuali. L'anta, priva di battuta, ha sempre un'apertura bidirezionale ed è disponibile con perno centrale o decentrato. La versione con perno centrale ha una rotazione di 360 gradi. Affiancando due o più pannelli, si possono configurare partizioni apribili parzialmente o totalmente. Il perfetto allineamento dei pannelli è garantito da un sistema magnetico (non è prevista una chiusura idraulica). Un vetro è applicato su un lato di un telaio in alluminio, disponibile in cinque finiture, in modo da avere una faccia con superficie planare e l'altra con superficie arretrata rispetto alla cornice perimetrale. Il vetro può essere monolitico temperato 6 mm oppure stratificato 3+3 mm, disponibile in una vastissima gamma di finiture. Tutti i vetri sono certificati secondo le normative di sicurezza ANSI Z97.1 e UNI EN12150. Sono disponibili anche pannelli in gres o in legno con diverse finiture ed essenze. Il corpo della cerniera superiore è alloggiato all'interno di un profilo d'alluminio da inserire a filo del controsoffitto e verniciare con la pitturazione dello stesso.

EN

Aladin Spin Mono is a panel with a vertical pivoting rotary movement, with adjustable pivot hinges, which lends itself to numerous design solutions. The - door WITH NO STOP always has a bidirectional opening and is available with a central or offset pin. The version with central pivot has a rotation of 360 degrees. By placing two or more panels side by side, you can configure partially or totally openable partitions. The perfect alignment of the panels is guaranteed by a magnetic system (there is no hydraulic closure). Glass is applied on one side of an aluminum frame, available in five finishes, so as to have a face with a flush surface and the other with a recessed surface with respect to the perimeter frame. The glass can be 6 mm tempered monolithic or 3 + 3 mm laminated, available in a wide range of finishes. The glass is certified according to the ANSI Z97.1 and UNI EN12150 safety standards. Ceramic or wooden panels with different finishes and veneers are also available. The body of the upper hinge is housed inside an aluminum profile, to be inserted flush with the false ceiling and painted as per the wall finish.

FR

Aladin Spin Mono est un panneau avec un mouvement de rotation vertical pivotant, avec des charnières pivotantes ajustables, qui se prête à de nombreuses solutions de design. La porte sans butée a toujours une ouverture bidirectionnelle et elle est disponible avec une pivot central ou décentralisé. La version avec pivot central a une rotation de 360 degrés. En plaçant deux ou plusieurs panneaux côte à côte, on peut configurer des partitions partiellement ou totalement ouvrables. L'alignement parfait des panneaux est garanti par un système magnétique (il n'y a pas de fermeture hydraulique). Un verre est appliqué sur un côté d'un cadre en aluminium, disponible en cinq finitions, de manière à avoir une face avec une surface plane et l'autre avec une surface en retrait par rapport au cadre périmétrique. Le verre peut être monolithique trempé de 6 mm ou stratifié de 3 + 3 mm, disponible dans une large gamme de finitions. Tous les verres sont certifiés selon les normes de sécurité ANSI Z97.1 et UNI EN12150. Des panneaux en céramique ou en bois avec différentes finitions et essences sont également disponibles. Le corps de la charnière supérieure est logé dans un profil en aluminium à insérer à fil du faux plafond et peint avec la peinture correspondante.



DE

Aladin Spin Mono ist ein vertikal drehbares Paneel, das mittels eines Stiftes und verstellbaren Zapfenschärniere zwischen Boden und Decke verspannt wird und geeignet für zahlreiche Designlösungen ist. Die Tür, ohne Anschlag, kann beidseitig geöffnet werden. Die Montage des Stiftes ist zentral oder dezentral möglich. Die Version mit zentralem Stift ist um 360 Grad drehbar. Indem Sie zwei oder mehrere Paneele nebeneinanderstellen, können Sie Raumteiler gestalten, die man partiell oder komplett öffnen kann. Die perfekte Ausrichtung der Paneele wird durch ein Magnetsystem gewährleistet (Kein hydraulischer Verschluss ist vorgesehen). Das Glas ist einseitig auf ein Aluminiumrahmen aufgeklebt, so dass es bündig mit dem Rahmen abschließt und auf der Gegenseite zurückspringt. Der Rahmen ist in fünf verschiedenen Ausführungen erhältlich. Das Glas, das in einer breiten Auswahl von Ausführungen verfügbar ist, kann 6 mm. monolithisch gehärtet oder 3+3 mm. stark beschichtet sein. Alle Gläser sind gemäß ANSI Z97.1 und UNI EN12150 zertifiziert. Gres- und Holzpaneele in verschiedenen Ausführungen und Hölzern sind ebenfalls erhältlich. Das nicht verblendbare Deckenprofil aus Aluminium wird bündig in einer Zwischendecke montiert und in der gleichen Deckenfarbe angestrichen.

ES

Aladin Spin Mono es un panel con movimiento de rotación a pivotante vertical, con bisagras a perno ajustable, que se presta a numerosas soluciones de proyectos. La puerta, sin renvalso, tiene siempre una apertura bidireccional y está disponible con perno central o descentrado. La versión con perno central tiene una rotación de 360°. Flanqueando dos o más paneles, se pueden configurar particiones que se abren parcialmente o totalmente. La perfecta alineación de los paneles está garantizada por un sistema magnético (no hay cierre hidráulico). Un cristal está aplicado en un lado de un marco de aluminio, disponible en cinco acabados, con el fin de tener una cara con superficie retraída respecto al marco perimetral. El cristal puede ser monolitico templado 6 mm o estratificado 3+3 mm, disponibles en una amplia gama de acabados. Todos los cristales son certificados según las normativas de seguridad ANSI Z97.1 y UNI EN12150. Están disponibles también en paneles de gres o de madera con diferentes acabados. El cuerpo de la bisagra superior está en el interior de un perfil de aluminio, para insertar al falso techo y barnizar con la pintura del mismo.

Aladin Spin Mono

Design Piero Lissoni

ANTA SPIN / SPIN DOOR

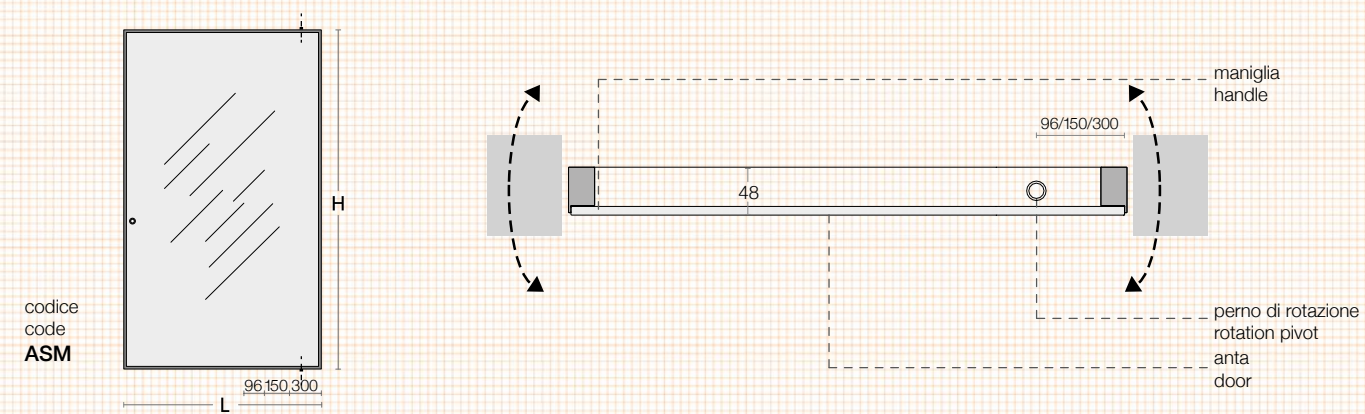
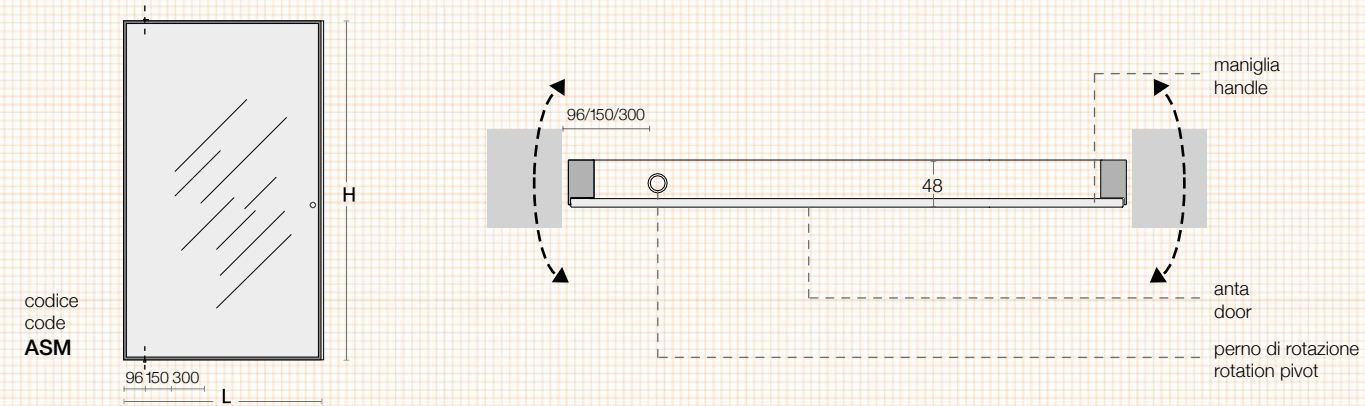
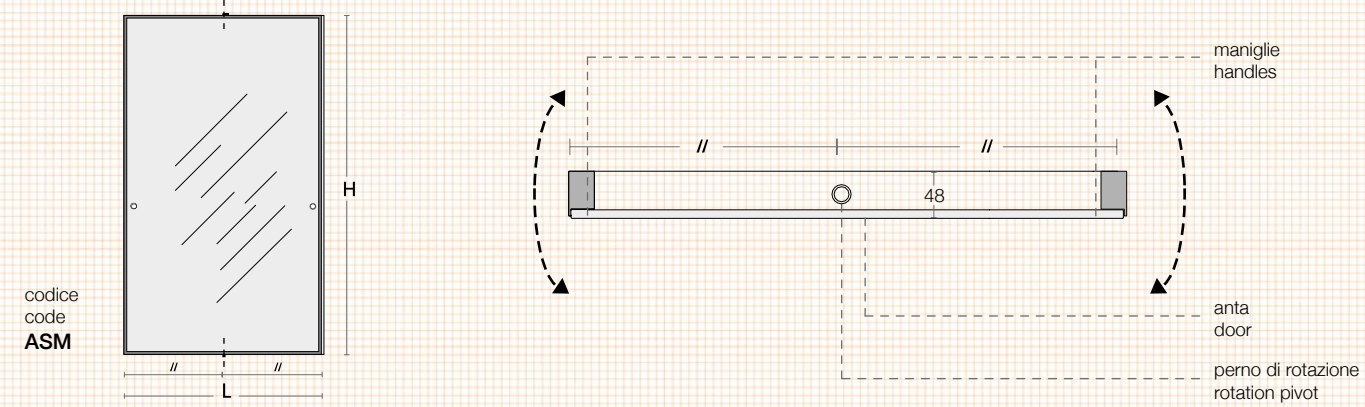

MANIGLIE ALADIN SPIN MONO / HANDLES ALADIN SPIN MONO

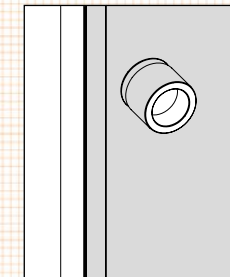

maniglia senza supporto /
handle without support

codice / code :
MSS2

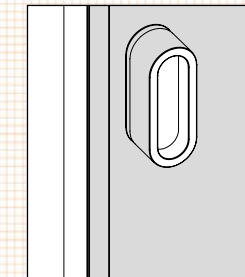

maniglia ovale senza supporto /
oval handle without support

codice / code :
MSO2

IT

Aladin Spin Duo è un pannello con movimento rotatorio a bilico verticale, con cerniere a perno regolabili, che si presta a numerose soluzioni progettuali. L'anta, priva di battuta, ha sempre un'apertura bidirezionale ed è disponibile con perno centrale o decentrato. La versione con perno centrale ha una rotazione di 360 gradi. Affiancando due o più pannelli, si possono configurare partizioni apribili parzialmente o totalmente. Il perfetto allineamento dei pannelli è garantito da un sistema magnetico (non è prevista una chiusura idraulica). Vetri temperati spessore 4 mm sono applicati su entrambe le facce di un telaio in alluminio, disponibile in cinque finiture, in modo da formare un volume con una camera d'aria interna. I vetri, disponibili in un'ampia gamma di finiture, sono certificati secondo le normative di sicurezza ANSI Z97.1 e UNI EN12150. Sono disponibili anche pannelli in gres o in legno con diverse finiture ed essenze. Il corpo della cerniera superiore è alloggiato all'interno di un profilo d'alluminio, da inserire a filo del controsoffitto e verniciare con la pitturazione dello stesso.

EN

Aladin Spin Duo is a panel with a vertical pivoting revolving movement, with adjustable pivot hinges, which lends itself to numerous design solutions. The door with no stop always has a bidirectional opening and is available with a central or offset pivot. The version with central pivot has a rotation of 360 degrees. By placing two or more panels side by side, you can configure partially or totally openable partitions. The perfect alignment of the panels is guaranteed by a magnetic system (there is no hydraulic closure) 4 mm thick tempered glass is applied to both sides of an aluminum frame, available in five finishes, to form a volume with an internal air chamber. The glass, available in a wide range of finishes, is certified according to the ANSI Z97.1 and UNI EN12150 safety standards. Ceramic or wooden panels with different finishes and veneers are also available. The body of the upper hinge is housed inside an aluminum profile, to be inserted flush with the false ceiling and painted as per the wall finish.

FR

Aladin Spin Duo est un panneau avec un mouvement de rotation vertical pivotant, avec des charnières pivotantes ajustables, qui se prête à de nombreuses solutions de design. La porte sans butée a toujours une ouverture bidirectionnelle et elle est disponible avec un pivot central ou décentralisé. La version avec pivot central a une rotation de 360 degrés. En plaçant deux ou plusieurs panneaux côte à côte, on peut configurer des partitions partiellement ou totalement ouvrables. L'alignement parfait des panneaux est garanti par un système magnétique (il n'y a pas de fermeture hydraulique). Des verres trempés de 4 mm d'épaisseur sont appliqués sur les deux côtés d'un cadre en aluminium, disponible en cinq finitions, de manière à former un volume d'air intérieur. Les verres, disponibles dans une large gamme de finitions, sont certifiés selon les normes de sécurité ANSI Z97.1 et UNI EN12150. Panneaux en céramique ou en bois avec différentes finitions et essences sont également disponibles. Le corps de la charnière supérieure est logé dans un profil en aluminium, pour être inséré à fil du faux plafond et peint avec la peinture correspondante.



DE

Aladin Spin Duo ist ein vertikal drehbares Paneel, das mittels eines Stiftes und verstellbaren Zapfenschärfen zwischen Boden und Decke verspannt wird und geeignet für zahlreiche Designlösungen ist. Die Tür, ohne Anschlag, kann beidseitig geöffnet werden. Die Montage des Stiftes ist zentral oder dezentral möglich. Die Version mit zentralem Stift ist um 360 Grad drehbar. Indem Sie zwei oder mehrere Paneele nebeneinanderstellen, können Sie Raumteiler gestalten, die man partiell oder komplett öffnen kann. Die parallele Ausrichtung der Paneele wird durch ein Magnetsystem gewährleistet (Kein hydraulischer Verschluss ist vorgesehen). Die 4 mm starken gehärteten Gläser werden beidseitig auf einen Aluminiumrahmen aufgeklebt, der in fünf verschiedenen Ausführungen erhältlich ist. Zwischen den Füllungen besteht einen Luftraum. Die Gläser, die in einer Vielzahl von Ausführungen erhältlich sind, sind gemäß ANSI Z97.1 und UNI EN12150 zertifiziert. Gres- und Holzpaneele in verschiedenen Ausführungen und Hölzern sind ebenfalls erhältlich. Das nicht verblendbare Deckenprofil aus Aluminium wird bündig in einer Zwischendecke montiert und in der gleichen Deckenfarbe angestrichen.

ES

Aladin Spin Duo es un panel con movimiento de rotación a pivotante vertical, con bisagras a perno ajustable, que se presta a numerosas soluciones de proyectos. La puerta, sin renvalso, tiene siempre una apertura bidireccional y está disponible con perno central o descentrado. La versión con perno central tiene una rotación de 360°. Flanqueando dos o más paneles, se pueden configurar particiones que se abren parcialmente o totalmente. La perfecta alineación de los paneles está garantizada por un sistema magnético (no hay cierre hidráulico). Los cristales templados de 4 mm de espesor están aplicados en ambas caras de un marco de aluminio, disponible en cinco acabados, con el fin de crear volumen con una cámara de aire interna. Los cristales, disponibles en una amplia gama de acabados, son certificados según las normativas de seguridad ANSI Z97.1 y UNI EN12150. Está disponibles también en paneles de gres o de madera con diferentes acabados. El cuerpo de la bisagra superior está en el interior de un perfil de aluminio, para insertar al falso techo y barnizar con la pintura del mismo.

Aladin Spin Duo

Design Piero Lissoni

ANTA SPIN / SPIN DOOR

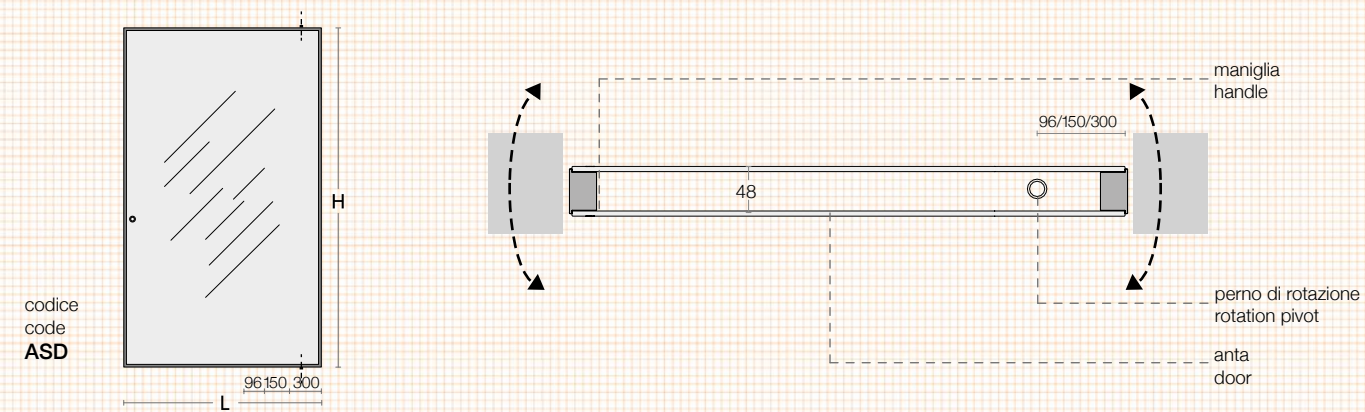
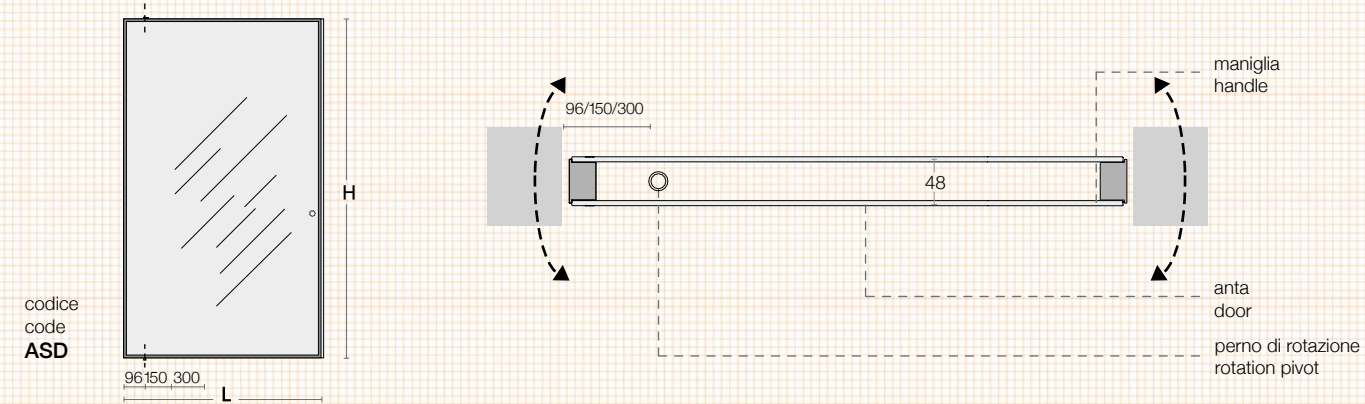
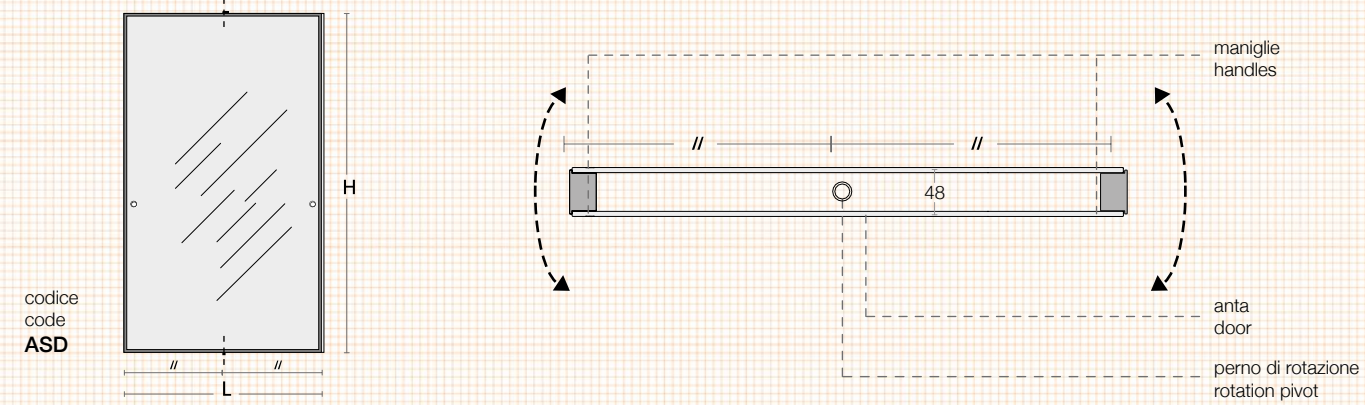

MANIGLIE ALADIN SPIN DUO / HANDLES ALADIN SPIN DUO

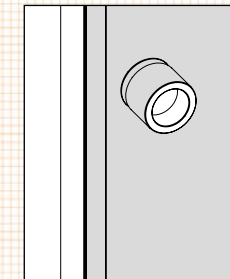

maniglia senza supporto /
handle without support

codice / code :
MSS2

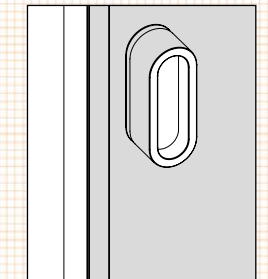

maniglia ovale senza supporto /
oval handle without support

codice / code :
MSO2

IT

Il **sistema scorrevole** Glas Italia è composto da un binario regolabile a una o più vie, contenuto in una trave d'alluminio con fissaggio a parete o a soffitto, incassata nel cartongesso o sospesa.

Trave e binario vengono forniti sezionati su misura.

Le ante, prodotte nella versione mono lastra Aladin Slide Mono, Sherazade Slide o doppia lastra Aladin Slide Duo, con telaio d'alluminio disponibile in cinque finiture, vengono appese al binario per mezzo di carrelli con scorrimento fluido e silenzioso. La chiusura delle ante, grazie a dei rallentatori posti a fine corsa, risulta essere molto dolce e precisa.

Le ante possono anche essere bloccate e utilizzate come pannellature divisorie fisse; è inoltre possibile montare maniglie con o senza serratura e profili di battuta di diverse tipologie.

Il sistema non ha guida a terra.

EN

The Glas Italia **sliding system** is composed by an adjustable one-way or more-ways rail, contained in an aluminium beam, fixed whether on the wall or on the ceiling, recessed into the drywall or hanging. Beam and rail are supplied custom-cut. The doors, produced in the single panel version Aladin Slide Mono, Sherazade Slide or double panel Aladin Slide Duo, with aluminium frame available in five different finishes, are hanged on the rail thanks to carriages with fluid and silent sliding. The closing of the doors, thanks to a soft motion placed at the end of the rail, is very soft and precise. Doors can be also blocked and used as fixed wall partitions.

It is possible to assemble different handles with or without lock and different kinds of door-strikers profiles.

The system has no guiding tracks.

FR

Le **système coulissant** Glas Italia se compose d'un rail réglable à une ou plusieurs voies, contenu dans une poutre en aluminium avec fixation au mur ou au plafond, encastrée dans le Placoplatre ou suspendu.

Poutre et rail sont fournis coupés sur mesure. Les portes, produites dans la version simple panneau, Aladin Slide Mono, Sherazade Slide ou double panneau, Aladin Slide Duo, avec cadre en aluminium disponible en cinq finitions, sont accrochées au rail au moyen de chariots avec glissement doux et silencieux. La fermeture des portes, grâce à un système de ralentissement en fin de course, est très douce et précise. Les portes peuvent aussi être bloquées et utilisées comme panneaux de cloisonnement fixes; c'est en outre possible monter poignées avec ou sans serrure et différents modèles de profil de feuillure.

Le système n'a pas de guidage au sol.

**DE**

Das Glas Italia **schiebsystem** besteht aus einer verstellbaren Ein- oder Mehrläufigschiene, die in einem Tragbalken aus Aluminium enthalten ist. Der Tragbalken, wird an der Wand oder an der Decke befestigt, integriert im Gipskarton oder hängend. Der Tragbalken und die Schiene sind vorhanden nach Maß geschnitten.

Die Einzelpaneel Aladin Slide Mono, Sherazade Slide oder Doppelpaneel Aladin Slide Duo hergestellten Türen mit Aluminiumrahmen, in fünf Ausführungen verfügbar, werden durch Laufwagen mit fließendem und geräuschlosem Lauf an die Schiene aufgehängt. Das Türschließen, durch ein Endlauf-Verlangsamungs-System, ist ganz leicht und genau. Die Paneele können blockiert und als feste Trennwände verwendet werden: es ist auch möglich, Klink mit oder ohne Schloss und verschiedene Anschlagprofile der Seitenleisten zu montieren. Das System hat keine Bodenführung. Die Rahmeninstallation muss während der Rohbauphase durchgeführt werden, die Feinbearbeitung direkt beim Wände streichen Verfügbar auch in der Version mit Rahmen bündig mit der Decke. Die gesamte Griffbaugruppe wird mit einem speziellen, hygienischen Lack (geprüft nach ISO 22196: 2011) behandelt, der durch die Bekämpfung des Bakterienwachstums maximale Hygiene und Sauberkeit der Oberflächen garantiert.

ES

El **sistema corredero** Glas Italia está compuesto por una guía regulable a una o más vías, contenida en una viga de aluminio con fijación a pared o a techo, empotrada en el pladur o suspendida. La viga y la guía están equipadas cortadas a medida. El sistema no tiene guía a suelo. Las puertas, producidas en la versión mono panele Aladin Slide Mono, Sherazade Slide o doble panele Aladin Slide Duo, con el marco de aluminio, disponible en cinco acabados, se cuelgan a la guía por medio de carretillas con desplazamiento fluido y silencioso. El cierre de las puertas es muy suave y preciso, gracias a un sistema de ralentización puesto al final de la guía. Las puertas se pueden bloquear y utilizar como paneles divisorios fijos; es también posible montar manillas con o sin cerraduras y perfiles de golpe de diferentes tipos.

El sistema no tiene guía a suelo.

Sistema Scorrevole / Sliding System
binario a 1 via / 1 way rail

BINARIO A PARETE / WALL RAIL

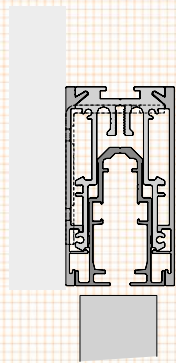

BINARIO A PARETE CARTONGESSO / WALL RAIL IN PLASTERBOARD

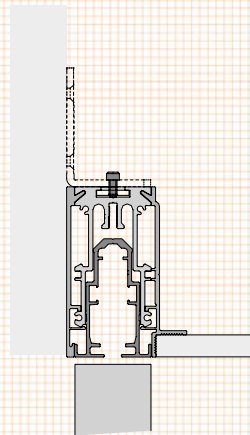

BINARIO A SOFFITTO / CEILING RAIL

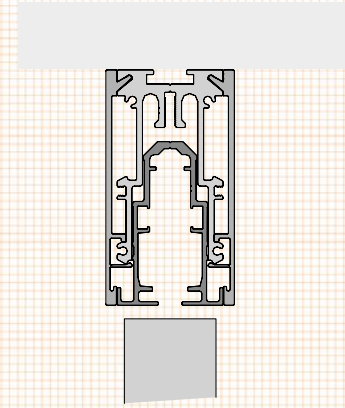

BINARIO A SOFFITTO CARTONGESSO / CEILING RAIL IN PLASTERBOARD

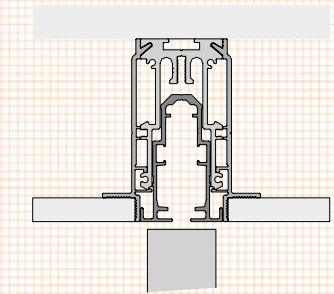
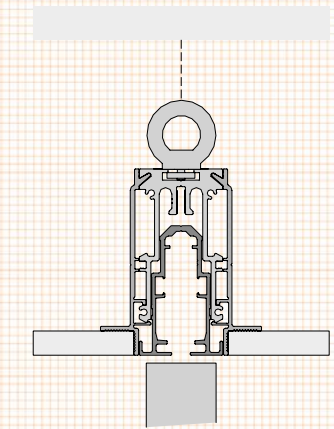

Sistema Scorrevole / Sliding System
binario a 2 vie / 2 ways rail

BINARIO A PARETE / WALL RAIL

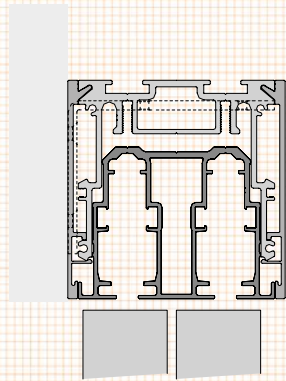

BINARIO A PARETE CARTONGESSO / WALL RAIL IN PLASTERBOARD

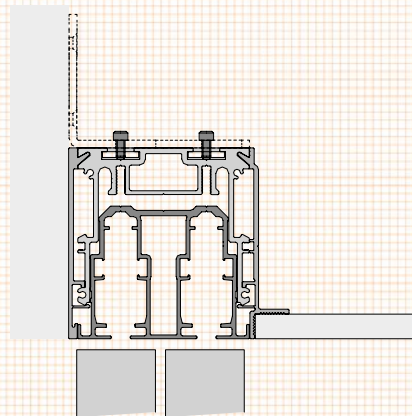

BINARIO A SOFFITTO / CEILING RAIL

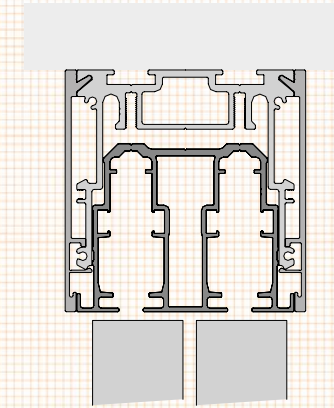

BINARIO A SOFFITTO CARTONGESSO / CEILING RAIL IN PLASTERBOARD

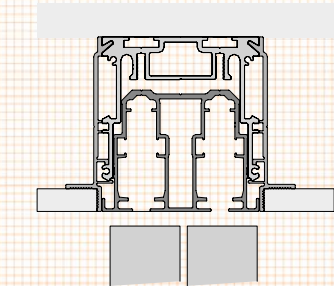
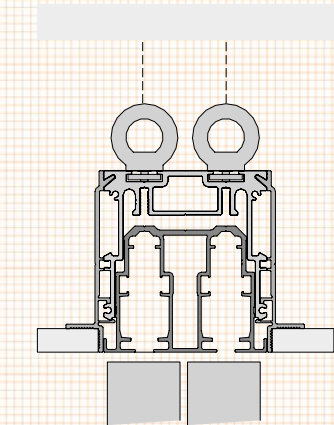

Sistema Scorrevole / Sliding System
binario a 3 vie / 3 ways rail

BINARIO A SOFFITTO / CEILING RAIL

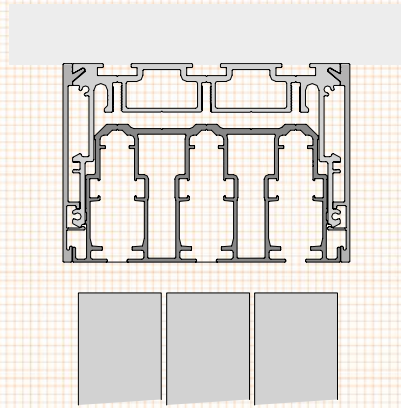

BINARIO A SOFFITTO CARTONGESSO / CEILING RAIL IN PLASTERBOARD

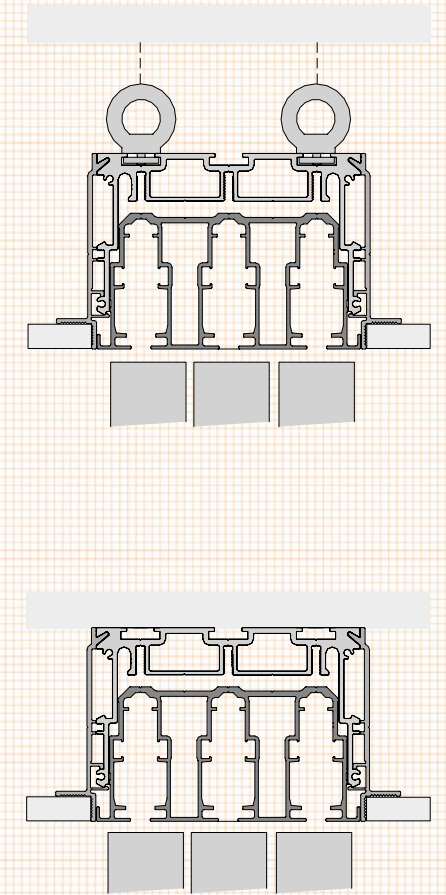

IT

Sherazade Slide è un'anta caratterizzate da grande eleganza e cura dei dettagli, con vetro temperato monolitico da 6 mm o stratificato 3+3 mm inserito tramite una guarnizione al centro di un telaio d'alluminio, fornito in cinque diverse finiture. I vetri, disponibili in una vastissima gamma di finiture, sono certificati secondo le normative di sicurezza ANSI Z97.1 e UNI ENI 2150 (ad eccezione di 533. armato).

Sono disponibili anche pannelli in gres o in legno, con diverse finiture ed essenze. Possono essere forniti anche pannelli fissi, da installare per mezzo di due profili fissati a soffitto e a pavimento.

**EN**

Sherazade Slide is a door characterized by great elegance and attention to details.

The monolithic 6 mm. or laminated 3+3 mm thick tempered glass is inserted by means of a seal in the center of the aluminium frame, which is supplied in five different finishes.

The glasses are available in a wide range of finishes and they are certified according to the safety regulations ANSI Z97.1 and UNI ENI 2150 (with the exception of 533. armato).

Panels in stoneware and in wood with different finishes and essences are available too.

Fixed panels can also be supplied, to be installed with two profiles fixed to the ceiling and to the floor.

DE

Sherazade Slide ist eine Schiebtür, von großer Eleganz und besonderer Qualität des Details gekennzeichnet. Das Glas kann 6 mm. stark monolithisch gehärtet oder 3+3 mm. stark beschichtet sein und es ist mittels einer Dichtung in der Mitte eines Aluminiumrahmens eingesetzt, der in fünf verschiedenen Ausführungen erhältlich ist.

Die Gläser, die in einer Vielzahl von Ausführungen erhältlich sind, sind gemäß ANSI Z97.1 und UNI ENI 2150 zertifiziert (außer für die Ausführung 533. armato).

Gres- und Holzpaneele in verschiedenen Ausführungen und Hölzern sind ebenfalls erhältlich. Man kann auch feste Paneele liefern, die mittels zwei in der Decke und im Boden angebrachten Profile installiert werden

FR

Sherazade Slide est une porte caractérisé par une grande élégance et le soin des détails, avec un verre trempé monolithique de 6 mm ou stratifié 3+3 mm inséré par un joint au milieu de un cadre en aluminium, fourni en cinq finitions différents.

Les verres sont disponibles dans une large gamme de finitions, ils sont certifiés selon les normes de sécurité ANSI Z97.1 et UNI ENI 2150 (à l'exception de la finition 533. armato).

Panneaux en grès et bois en différentes finitions et essences sont également disponibles.

Des panneaux fixes peuvent être fournis, à installer au moyen de deux profilés fixés au plafond et au planche.

ES

Sherazade Slide es una puerta caracterizada por la gran elegancia y atención a los detalles.

El cristal templado monolítico de 6 mm o estratificado 3+3 mm está insertado por medio de una junta en el centro del marco de aluminio, suministrado en cinco diferentes acabados.

Los cristales, disponibles en una amplia gama de acabados, son certificados según las normativas de seguridad ANSI Z97.1 y UNI ENI 2150 (a excepción de 533. armato).

Están disponibles también paneles de gres y madera con diferentes acabados y esencias.

También se pueden suministrar paneles fijos, para ser instalados mediante dos perfiles fijados al techo y al suelo.

Sherazade Slide

Design Piero Lissoni

PANNELLO / PANEL

codice
code
SSL

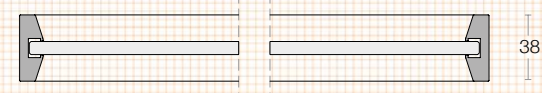
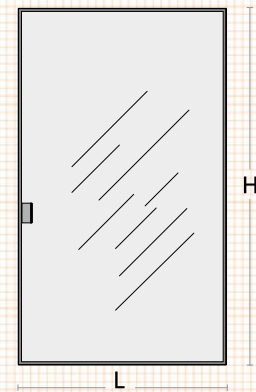

MANIGLIE / HANDLES

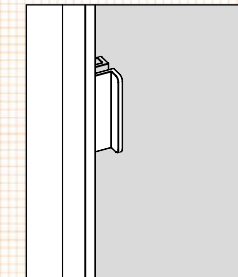

maniglia senza supporto /
handle without support

codice / code :
MSSS

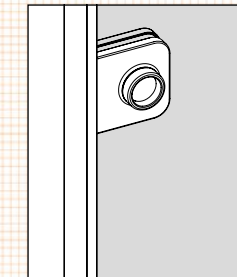

maniglia con supporto /
handle with support

codice / code :
MCSS

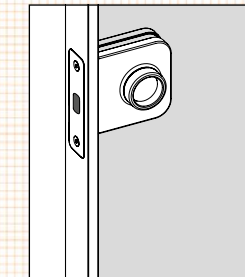

maniglia con nottolino /
handle with revolving plug

codice / code :
MCNS

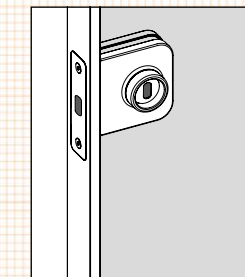

maniglia con chiave /
handle with key lock

codice / code :
MCCS

IT

Sherazade Slide Patchwork è un'anta dalla grande eleganza e cura dei dettagli, la cui superficie è ripartita in quattro riquadri, in cui possono essere posizionati diversi tipi di cristalli temperati monolitici mm 6 o stratificati mm 3+3. Questi pannelli, tramite una guarnizione, vengono inseriti al centro di profili d'alluminio, forniti in cinque diverse finiture. I vetri, disponibili in una vastissima gamma di finiture, sono certificati secondo le normative di sicurezza ANSI Z97.1 e UNI ENI 2150 (ad eccezione di 533. retinato). Possono essere forniti anche pannelli fissi, da installare per mezzo di due profili fissati a soffitto e a pavimento.

EN

Sherazade Slide Patchwork is a door panel of great detail and elegance whose surface is divided into four parts where different types of glass, tempered monolithic 6 mm or laminated 3+3 mm, can be used. These panels, fitted using a gasket, are inserted in the centre of the aluminum profiles, supplied in five different finishes. The glass, available in a very wide range of finishes, is certified in compliance with the ANSI Z97.1 and UNI ENI 2150 safety regulations (except the finish 533. retinato). Fixed panels can also be supplied, to be installed with two profiles fixed to the ceiling and to the floor.

FR

Sherazade Slide Patchwork est une porte de grande élégance et soin des détails, dont la surface est divisée en quatre panneaux, dans lesquels différents types de verre trempé monolithique mm 6 ou stratifié mm 3 + 3 peuvent être positionnés. Ces panneaux, à travers un joint, sont insérés au centre des profils en aluminium, fournis en cinq finitions différentes. Les verres, disponibles dans une vaste gamme de finitions, sont certifiés selon les normes de sécurité ANSI Z97.1 et UNI EN12150 (exclue la finition 533. retinato). Des panneaux fixes peuvent être fournis, à installer au moyen de deux profilés fixés au plafond et au planche.



DE

Sherazade Slide Patchwork ist eine Tür gekennzeichnet durch außergewöhnliche Eleganz und besondere Qualität der Details. Die Oberfläche ist auf vier Felder aufgeteilt, wo verschiedene Glastypologien von 6 mm starken monolithischen gehärteten Gläsern oder 3+3 mm starken beschichteten Gläsern platziert werden können. Diese Glaspaneele sind mittels einer Dichtung in dem Aluminiumrahmen eingesetzt, der in fünf verschiedenen Ausführungen erhältlich ist. Die Gläser sind in einer sehr weiten Serie von Ausführungen verfügbar und sind gemäß ANSI Z97.1 und UNI ENI 2150 zertifiziert (ausschließlich 533. retinato). Man kann auch feste Paneele liefern, die mittels zwei in der Decke und im Boden angebrachten Profile installiert werden.

ES

Sherazade Slide Patchwork es una puerta caracterizada por la gran elegancia y atención a los detalles, cuya superficie está dividida en cuatro cuadrados, donde se pueden posicionar diferentes tipos de cristales templados monolíticos de 6 mm o estratificado 3+3 mm. Estos paneles, por medio de una junta, están insertados en el centro del marco de aluminio, suministrado en cuatro acabados diferentes. Los cristales, disponibles en una amplia gama de acabados, son certificados según las normativas de seguridad ANSI Z97.1 y UNI ENI 2150 (533. retinato excluido). También se pueden suministrar paneles fijos, para ser instalados mediante dos perfiles fijados al techo y al suelo.

Sherazade Slide Patchwork

Design Piero Lissoni

PANNELLO / PANEL

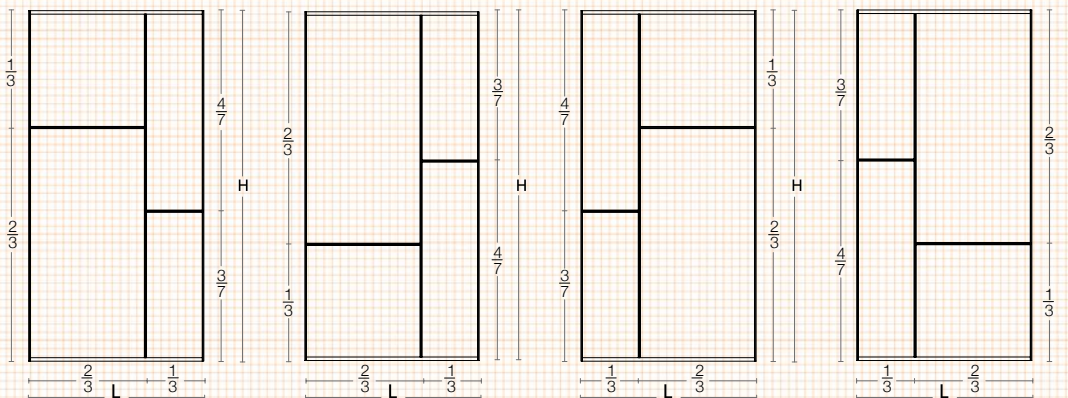
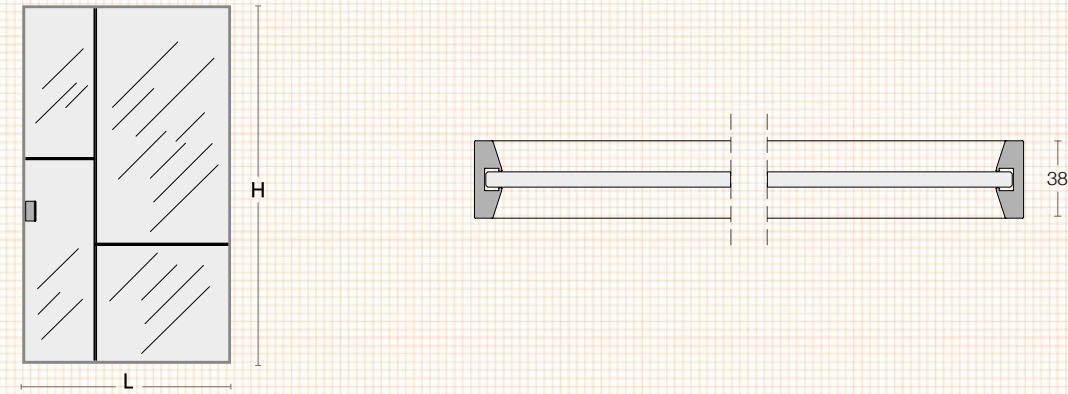

codice / code :
SSLP01

codice / code :
SSLP02

codice / code :
SSLP03

codice / code :
SSLP04

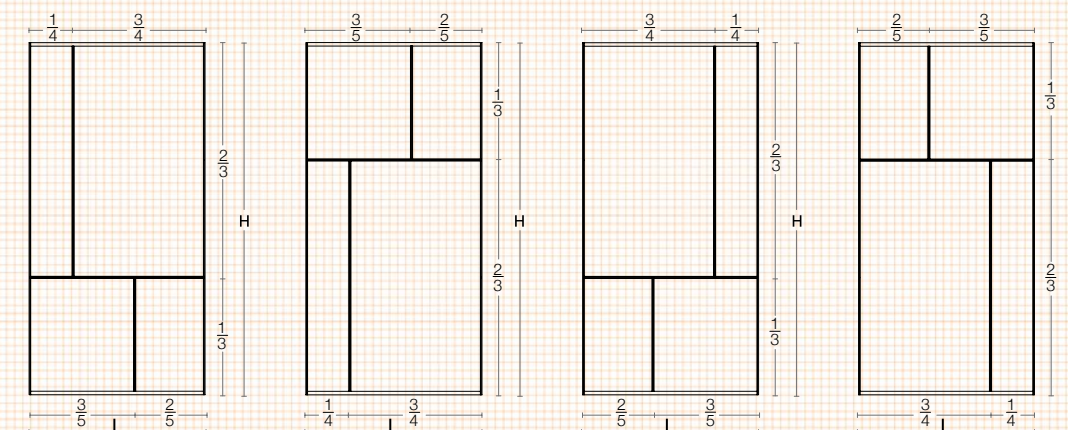

codice / code :
SSLP05

codice / code :
SSLP06

codice / code :
SSLP07

codice / code :
SSLP08

MANIGLIE SHERAZADE SLIDE PATCHWORK / HANDLES SHERAZADE SLIDE PATCHWORK

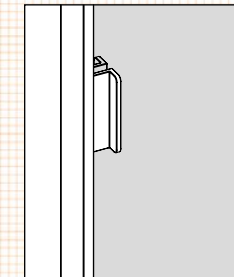

maniglia senza supporto /
handle without support

codice / code :
MSSS

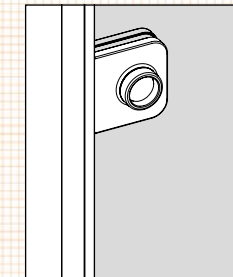

maniglia con supporto /
handle with support

codice / code :
MCSS

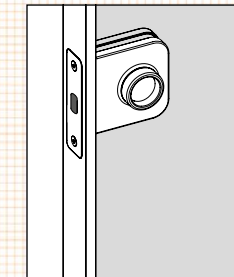

maniglia con nottolino /
handle with revolving plug

codice / code :
MCNS

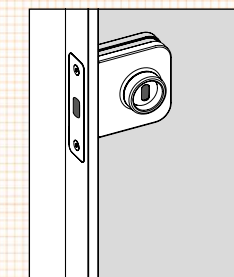

maniglia con chiave /
handle with key lock

codice / code :
MCCS

IT

Le ante **Aladin Slide Mono** hanno un vetro applicato su un lato del telaio, in modo da avere una faccia con superficie planare e l'altra con superficie arretrata rispetto alla cornice perimetrale d'alluminio disponibile in cinque diverse finiture. Il vetro, disponibile in una vastissima gamma di finiture, può essere monolitico temperato 6 mm oppure stratificato 3 + 3 mm. Tutti i vetri sono certificati secondo le normative di sicurezza ANSI Z97.1 e UNI EN12150. Sono disponibili anche pannelli in gres con diverse finiture.

Possono essere forniti anche pannelli fissi, da installare per mezzo di due profili fissati a soffitto e a pavimento.

**EN**

The **Aladin Slide Mono** doors have a glass applied on one side of the frame so that one side has a flush surface and the other is rebated from the aluminium frame available in five different finishes.

The glass, available in a wide range of finishes, can be monolithic tempered 6 mm in a single piece or laminated 3 + 3 mm. All glasses are certified according to the safety regulation ANSI Z97.1 and UNI EN12150.

Panels in stoneware with different finishes are available too.

Fixed panels can also be supplied, to be installed with two profiles fixed to the ceiling and to the floor.

DE

Aladin Slide Mono Türen haben in dem umlaufenden Aluminiumrahmen eine einseitige Glasfüllung, die bündig mit dem Rahmen abschließt und auf der Gegenseite zurückspringt. Der Rahmen ist in fünf verschiedenen Ausführungen erhältlich. Das Glas, das in einer breiten Auswahl von Ausführungen verfügbar ist, kann 6 mm monolithisch gehärtet oder 3 + 3 mm. stark beschichtet sein. Alle Gläser sind gemäß ANSI Z97.1 und UNI EN 12150 zertifiziert. Grespaneele in verschiedenen Ausführungen sind ebenfalls erhältlich. Man kann auch feste Paneele liefern, die mittels zwei in der Decke und im Boden angebrachten Profile installiert werden.

FR

Les portes **Aladin Slide Mono** ont un cristal appliqué sur un côté du cadre de façon à avoir un côté avec surface plane et l'autre côté avec une surface en retrait par rapport au cadre périmétrique en aluminium disponible en cinq finitions différents. Le cristal, disponible dans une large gamme de finitions, peut être monolithique trempé 6 mm ou stratifié 3 + 3 mm. Tous les verres sont certifiés selon les normes de sécurité ANSI Z97.1 et UNI EN12150.

Panneaux en grès en différentes finitions sont également disponibles.

Des panneaux fixes peuvent être fournis, à installer au moyen de deux profilés fixés au plafond et au planche.

ES

Las puertas **Aladin Slide Mono** tienen un cristal aplicado en un lado del marco, con el fin de tener una cara con una superficie coplanar y la otra con superficie retraída respecto al marco perimetral de aluminio disponible en cincodiferentes acabados. El cristal, disponible en una amplia gama de acabados, puede ser monolítico templado 6 mm o laminado 3 + 3 mm. Todos los cristales son certificados según las normativas de seguridad ANSI Z97.1 y UNI EN12150. Estàn disponibles también paneles de gres con diferentes acabados.

También se pueden suministrar paneles fijos, para ser instalados mediante dos perfiles fijados al techo y al suelo.

Aladin Slide Mono

Design Piero Lissoni

PANNELLO / PANEL

codice
code
ASLM

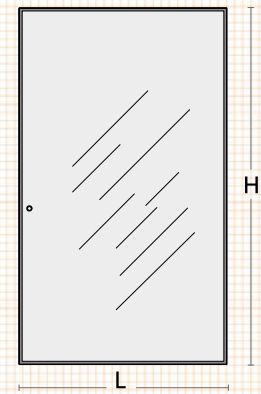

MANIGLIE PANNELLO MONO / HANDLES PANEL MONO

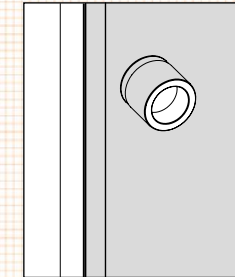

maniglia tonda
senza supporto /
round handle
without support

codice / code :
MSS

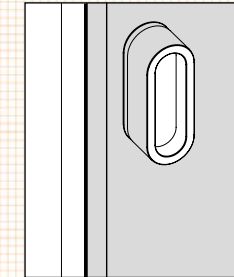

maniglia ovale
senza supporto /
oval handle
without support

codice / code :
MSO

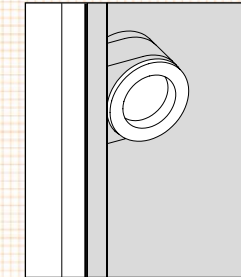

maniglia con supporto /
handle with support

codice / code :
MCS

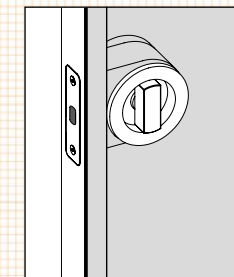

maniglia con nottolino /
handle with revolving plug

codice / code :
MCN

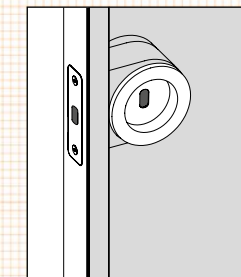

maniglia con chiave /
handle with key lock

codice / code :
MCC

IT

Le ante **Aladin Slide Duo** hanno vetri temperati spessore 4 mm, applicati su entrambe le facce del telaio d'alluminio, disponibile in cinque diverse finiture, in modo da formare un volume con una camera d'aria interna.

I vetri, disponibili in un'ampia gamma di finiture, sono certificati secondo le normative di sicurezza ANSI Z97.1 e UNI EN12150. Sono disponibili anche pannelli in gres o in legno, con diverse finiture ed essenze.

Possono essere forniti anche pannelli fissi, da installare per mezzo di due profili fissati a soffitto e a pavimento.

**EN**

The **Aladin Slide Duo** doors, have 4 mm thick tempered glass applied on both faces of the aluminium frame available in five different finishes, so as to form a volume with an internal air chamber.

The glasses are available in a wide range of finishes and they are certified according to the safety regulation ANSI Z97.1 and UNI EN12150. Panels in stoneware and in wood with different finishes and essences are available too.

Fixed panels can also be supplied, to be installed with two profiles fixed to the ceiling and to the floor.

DE

Aladin Slide Duo Türen sind beidseitig mit 4 mm starken Glaspaneelen gefüllt. Der Rahmen ist in fünf verschiedenen Ausführungen erhältlich. Zwischen den Füllungen besteht ein Luftraum. Die Gläser, die in einer Vielzahl von Ausführungen erhältlich sind, sind gemäß ANSI Z97.1 e UNI EN12150 zertifiziert. Gres- und Holzpaneele in verschiedenen Ausführungen und Hölzern sind ebenfalls erhältlich. Man kann auch feste Paneele liefern, die mittels zwei in der Decke und im Boden angebrachten Profile installiert werden.

FR

Les portes **Aladin Slide Duo** ont des cristaux trempés épaisseur 4 mm appliqués sur les deux côtés du cadre en aluminium, disponible en cinq finitions différents, de manière à former un volume d'air intérieur.

Les verres, disponibles dans une large gamme de finitions, sont certifiés selon les normes de sécurité ANSI Z97.1 et UNI EN12150. Panneaux en grès et bois en différentes finitions et essences sont également disponibles.

Des panneaux fixes peuvent être fournis, à installer au moyen de deux profilés fixés au plafond et au planche.

ES

Las puertas **Aladin Slide Duo** tienen cristales templados de 4 mm de espesor y están aplicados en ambos caras del marco de aluminio, disponible en cinco diferentes acabados, con el fin de crear un volumen con una cámara de aire interna. Los cristales, disponibles en una amplia gama de acabados, son certificados según las normativas de seguridad ANSI Z97.1 y UNI EN12150. Paneaux en grès et bois en différentes finitions et essences sont également disponibles. También se pueden suministrar paneles fijos, para ser instalados mediante dos perfiles fijados al techo y al suelo.

Aladin Slide Duo

Design Piero Lissoni

PANNELLO / PANEL

codice
code
ASLD

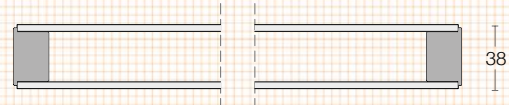

MANIGLIE PANNELLO DUO / HANDLES PANEL DUO

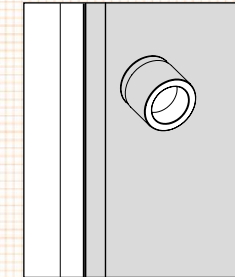

maniglia tonda
senza supporto /
round handle
without support

codice / code :
MSS

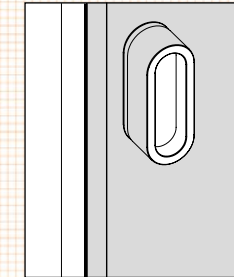

maniglia ovale
senza supporto /
oval handle
without support

codice / code :
MSO

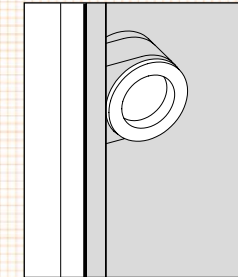

maniglia con supporto /
handle with support

codice / code :
MCS

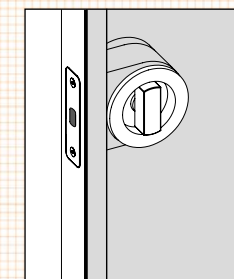

maniglia con nottolino /
handle with revolving plug

codice / code :
MCN

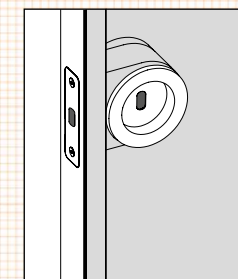

maniglia con chiave /
handle with key lock

codice / code :
MCC

IT

Il **sistema scorrevole Glas Italia per porte a scomparsa** è composto da un binario a una o più vie contenuto in una trave d'alluminio. Trave e binario vengono forniti sezionati su misura.

La trave viene fissata a soffitto o a parete prima della chiusura del vano, mentre il binario, fornito in finitura, volendo può essere installato anche successivamente, a lavori edili ultimati, grazie ad un funzionale sistema di aggancio a baionetta. Tale sistema permette al binario all'occorrenza di essere smontato.

EN

The **Glas Italia sliding system for pocket doors** consists of a single or a multi-way rail contained inside an aluminum beam. The beam and rail are supplied cut to custom size. The beam is fixed to the ceiling or wall before the door opening is finished, whereas the rail, supplied in color, can be installed later once the construction work has been completed, thanks to a functional bayonet connecting system. This system also allows the rail to be disassembled if necessary.

FR

Le **système coulissant Glas Italia pour portes à galandage** se compose d'un rail à une ou plusieurs voies contenu dans une poutre en aluminium. La poutre et le rail sont fournis coupés sur mesure.

La poutre est fixée au plafond ou à la paroi avant la fermeture du passage, alors que le rail, fourni en finition, peut également être installé successivement, une fois les travaux de construction terminés, grâce à un système fonctionnel d'accroche à baïonnette. Ce système permet de démonter le rail si nécessaire.



DE

Das **Schiebesystem Glas Italia für Taschentüren besteht** aus einer ein- oder mehrläufige Laufschiene, die in einer Tragschiene aus Aluminium enthalten ist. Tragschiene und Laufschiene werden nach Maß geschnitten geliefert. Die Tragschiene wird an der Decke oder an der Wand vor dem Ende des Durchgangs befestigt, während die Laufschiene, geliefert in Farbe, dank eines funktionalen Bajonett-Kupplungssystems auch nachträglich nach Ende der Bauarbeiten montiert werden kann. Dieses System ermöglicht die Demontage der Schiene bei Bedarf.

ES

El **sistema de corredera Glas Italia para puertas empotradas** consta de un carril de una o más vías contenido en una viga de aluminio. Viga y carril se suministran seccionados a medida.

La viga se fija al techo o a la pared antes de cerrar el compartimento, mientras que el carril, suministrado en acabado, también se puede instalar posteriormente, una vez finalizada la obra, gracias a un funcional sistema de enganche de bayoneta. Este sistema permite desmontar la pista si es necesario.

Sistema Scorrevole Glas Italia per porte a scomparsa /
Glas Italia Sliding System for pocket doors
binario a 1 via / 1 way rail

BINARIO A PARETE / WALL RAIL

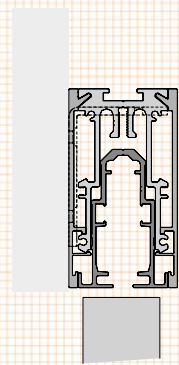

BINARIO A PARETE CARTONGESSO / WALL RAIL IN PLASTERBOARD

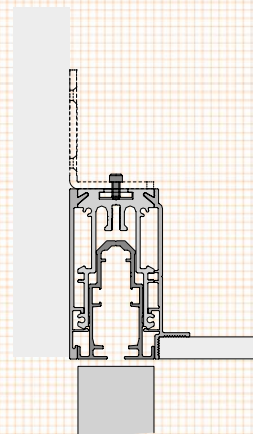

BINARIO A SOFFITTO / CEILING RAIL

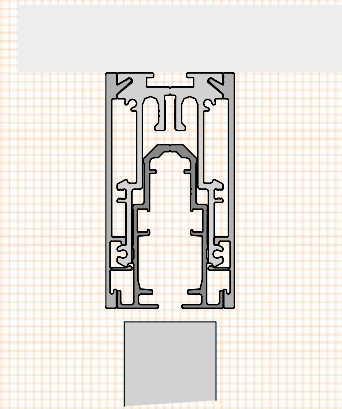

BINARIO A SOFFITTO CARTONGESSO / CEILING RAIL IN PLASTERBOARD

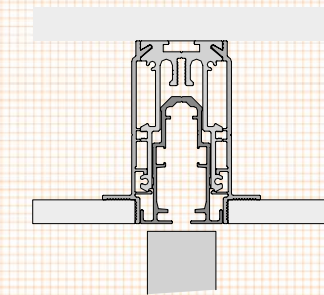
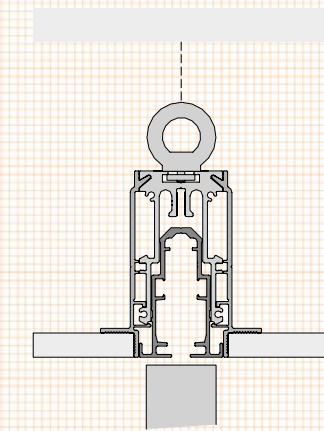

IT

Le ante **Sherazade Pocket**, prodotte su misura e perfettamente integrabili nei più diffusi sistemi di porte scorrevoli a scomparsa senza stipite, quali Scrigno Essential® Scorrevole ed Eclisse® SyntesisLine, hanno un vetro temperato monolitico da 6 mm o stratificato 3 + 3 mm inserito tramite una guarnizione al centro di un telaio d'alluminio, fornito in cinque diverse finiture. I vetri, disponibili in una vastissima gamma di finiture, sono certificati secondo le normative di sicurezza ANSI Z97.1 e UNI ENI 2150 (ad eccezione di 533. armato). Sono disponibili anche pannelli in gres o in legno, con diverse finiture ed essenze. Le due versioni ad anta singola e ad anta doppia possono essere fornite con o senza serratura. A richiesta vengono forniti anche i controtelai per cartongesso e intonaco.



EN

The **Sherazade Pocket** doors are custom-made, can be integrated into the most common systems of frameless sliding pocket doors such as Scrigno Essential® sliding and Eclisse® Syntesis Line and The monolithic 6 mm. or laminated glass 3 + 3 mm thick tempered glass is inserted by means of a seal in the center of the aluminum frame, which is supplied in five different finishes. The glass, available in a wide range of finishes are certified according to the safety regulation ANSI Z97.1 and UNI EN12150 (with the exception of 533. armato). Panels in stoneware and in wood with different finishes and essences are available too. The two versions, with single or double door, can be supplied with or without the lock. Subframes for plasterboard or brick walls can be provided on demand.

FR

Les portes **Sherazade Pocket**, produites sur mesure et parfaitement intégrables dans les plus diffuses systèmes de portes coulissantes à galandage sans cadre comme Scrigno Essential® coulissant et Eclisse® Syntesis Line, ont un verre monolithique trempé 6 mm ou stratifié 3 + 3 mm inséré par un joint au milieu de un cadre en aluminium, fourni en cinq finitions différents. Les verres sont disponibles dans une large gamme de finitions, ils sont certifiés selon les normes de sécurité ANSI Z97.1 et UNI ENI 2150 (à l'exception de la finition 533. armato). Panneaux en grès et bois en différentes finitions et essences sont également disponibles. Les deux versions, avec porte simple ou double porte sont fournies avec ou sans serrure. Sur demande les contre-châssis pour Placoplâtre et pour béton sont fournis.

DE

Sherazade Pocket Türen werden nach Maß hergestellt und sind mit den meistverbreiteten Führungsschienensystemen von rahmenlosen Schiebe-Taschentüren wie Scrigno Essential® und Eclisse® SyntesisLine kombinierbar. Das Glas kann 6 mm stark monolithisch gehärtet oder 3 + 3 mm. stark beschichtet sein und es ist mittels einer Dichtung in der Mitte eines Aluminiumrahmens eingesetzt, der in fünf verschiedenen Ausführungen erhältlich ist. Die Gläser, die in einer Vielzahl von Ausführungen erhältlich sind, sind gemäß ANSI Z97.1 und UNI ENI 2150 zertifiziert (außer für die Ausführung 533. armato). Gres- und Holzpaneele in verschiedenen Ausführungen und Hölzern sind ebenfalls erhältlich. Die zwei Varianten, Einzeltür und Doppeltür, können mit oder ohne Schloss vorhanden sein. Auf Wunsch können Doppelrahmen für Gipskarton- und Betonwände geliefert werden.

ES

Las puertas **Sherazade Pocket** son producidas a medida y son perfectamente integrables en los sistemas de puertas correderas empotradas sin jamba más utilizados, como Scrigno Essential® corredera y Eclisse® Syntesis Line. Estos paneles tienen un cristal templado monolítico de 6 mm o estratificado 3 + 3 mm está insertado por medio de una junta en el centro del marco de aluminio, suministrado en cinco diferentes acabados. Los cristales, disponibles en una amplia gama de acabados, son certificados según las normativas de seguridad ANSI Z97.1 y UNI ENI 2150 (a excepción de 533. armato). Están disponibles también paneles de gres y madera con diferentes acabados y esencias. Las dos versiones, con puerta simple o doble, pueden ser suministradas con o sin cerradura. A petición pueden ser suministrados los contramarcos para pladur y ladrillo.

Sherazade Pocket

Design Piero Lissoni

PORTA A SCOMPARSA SENZA STIPITE / POCKET DOOR WITH CONCEALED FRAME

codice
code
SPO1

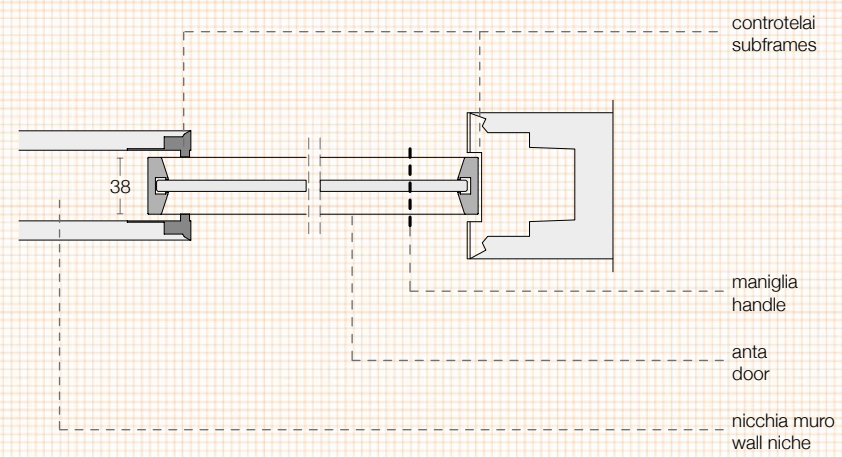
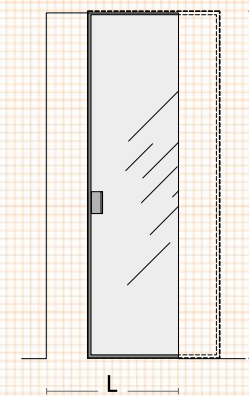

MANIGLIE SHERAZADE POKET / HANDLES SHERAZADE POKET

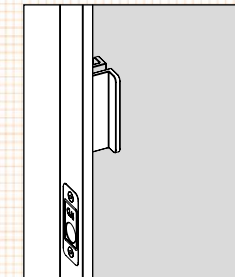

maniglia senza supporto /
handle without support

codice / code :
MSSSP

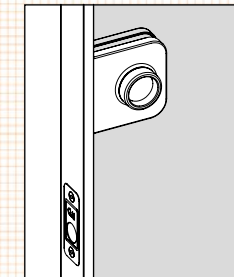

maniglia con supporto /
handle with support

codice / code :
MCSSP

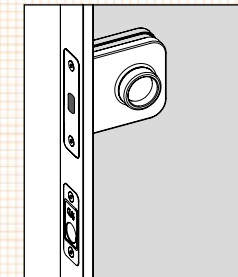

maniglia con nottolino /
handle with revolving plug

codice / code :
MCNSP

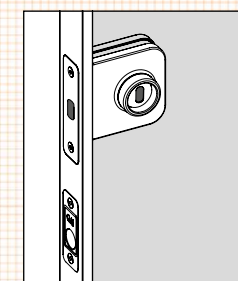

maniglia con chiave /
handle with key lock

codice / code :
MCCSP

Sherazade Double Pocket

Design Piero Lissoni

PORTA A SCOMPARSA SENZA STIPITE / POCKET DOOR WITH CONCEALED FRAME

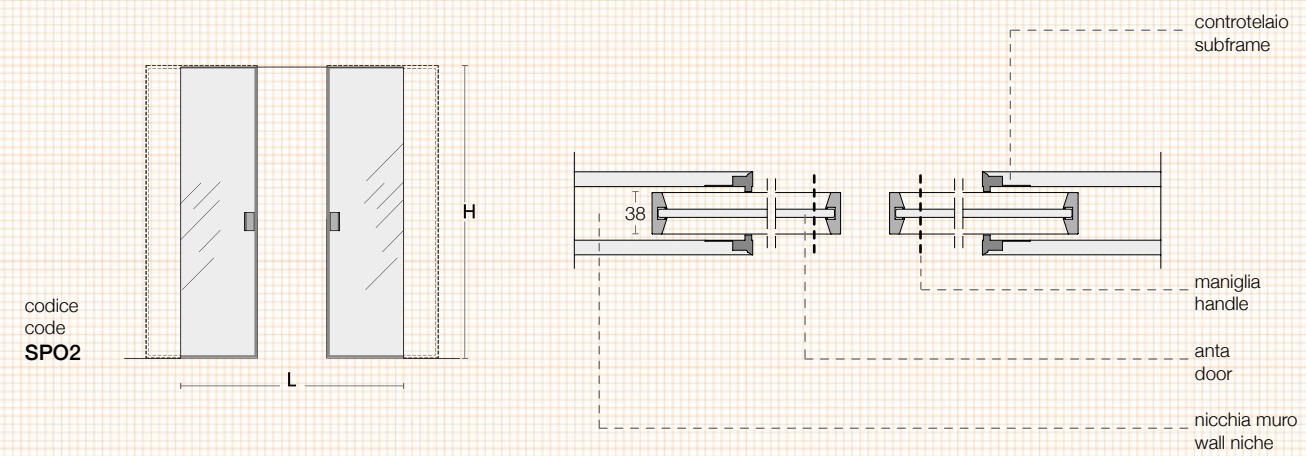

MANIGLIE PORTA A SCOMPARSA ANTA DOPPIA / HANDLES DOUBLE POCKET DOOR

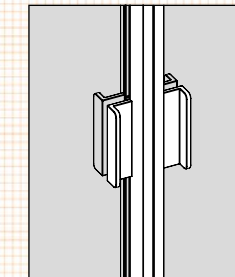

maniglia doppia
senza supporto /
double handle
without support

codice / code :
M2SSSP

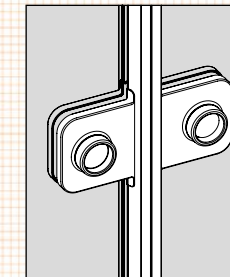

maniglia doppia
con supporto /
double handle
with support

codice / code :
M2CSSP

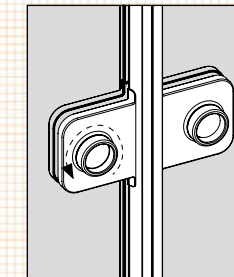

maniglia doppia
con nottolino /
double handle
with revolving plug

codice / code :
M2CNSP

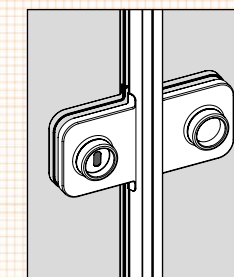

maniglia doppia
con chiave /
double handle
with key lock

codice / code :
M2CCSP

IT

Le ante **Sherazade Pocket Patchwork**, con le medesime caratteristiche di Sherazade Slide Patchwork, sono prodotte su misura e perfettamente integrabili nei più diffusi sistemi di porte scorrevoli a scomparsa senza stipite, quali Scigno Essential® Scorrevole ed Eclisse® SyntesisLine. Le due versioni ad anta singola e ad anta doppia possono essere fornite con o senza serratura. A richiesta vengono forniti anche i controtelai per cartongesso e intonaco.

**EN**

The **Sherazade Pocket Patchwork** doors, with the same features as Sherazade Slide Patchwork, are custom-made and can be integrated with the most common systems of sliding pocket doors without jamb, such as Scigno Essential® Scorrevole and Eclisse® SyntesisLine. The two versions, single or double door, are available with or without lock. Subframes for plasterboard or brick walls are available on demand.

DE

Die **Sherazade Pocket Patchwork** Türen sind durch dieselben Eigenschaften von Sherazade Slide Patchwork gekennzeichnet. Sie werden nach Maß hergestellt sind mit den meistverbreiteten Führungsschienensystemen von Schiebe-Taschentüren ohne Pfosten kombinierbar (wie Scigno Essential® und Eclisse® SyntesisLine). Die zwei Varianten, Einzeltür und Doppeltür, können mit oder ohne Schloss vorhanden sein. Auf Wunsch können Doppelrahmen für Gipskarton- und Betonwände geliefert werden.

FR

Les portes **Sherazade Pocket Patchwork**, avec les mêmes caractéristiques de Sherazade Slide Patchwork, sont produites sur mesure et parfaitement intégrables dans les plus diffusés systèmes de portes coulissantes à galandage, comme Scigno Essential® coulissant et Eclisse® SyntesisLine. Les deux versions avec porte simple et double porte peuvent être fournies avec ou sans serrure. Sur demande, les contrechâssis pour Placoplatre et pour béton sont fournis.

ES

Las puertas **Sherazade Pocket Patchwork**, con las mismas características de Sherazade Slide Patchwork, son producidas a medida y son perfectamente integrables en los sistemas de puertas correderas empotradas sin jamba más utilizados, como Scigno Essential® corredera y Eclisse® Syntesis Line. Las dos versiones, con puerta simple o doble, pueden ser suministradas con o sin cerradura. A petición pueden ser suministrados los contramarcos para pladur y ladrillo.

Sherazade Pocket Patchwork

Design Piero Lissoni

PORTA A SCOMPARSA SENZA STIPITE / POCKET DOOR WITH CONCEALED FRAME

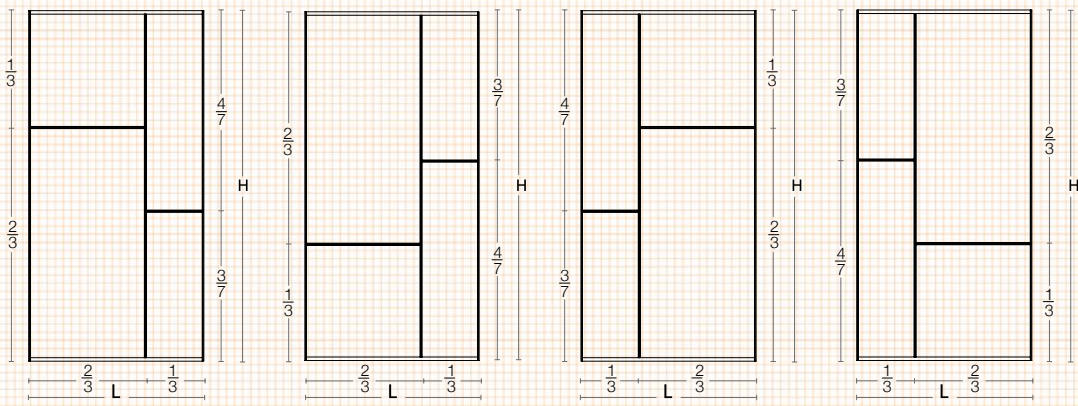
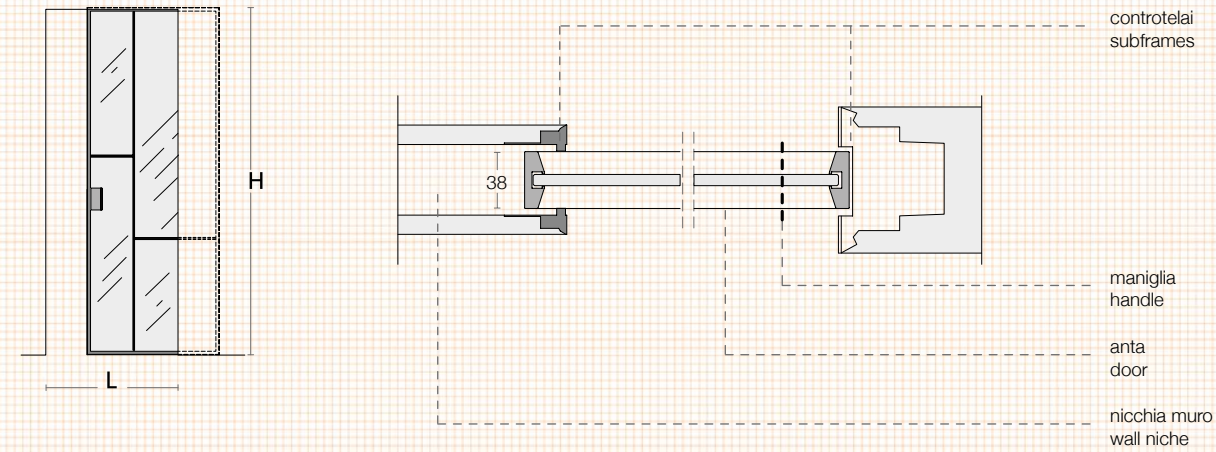

codice / code :
SPO1P01

codice / code :
SPO1P02

codice / code :
SPO1P03

codice / code :
SPO1P04

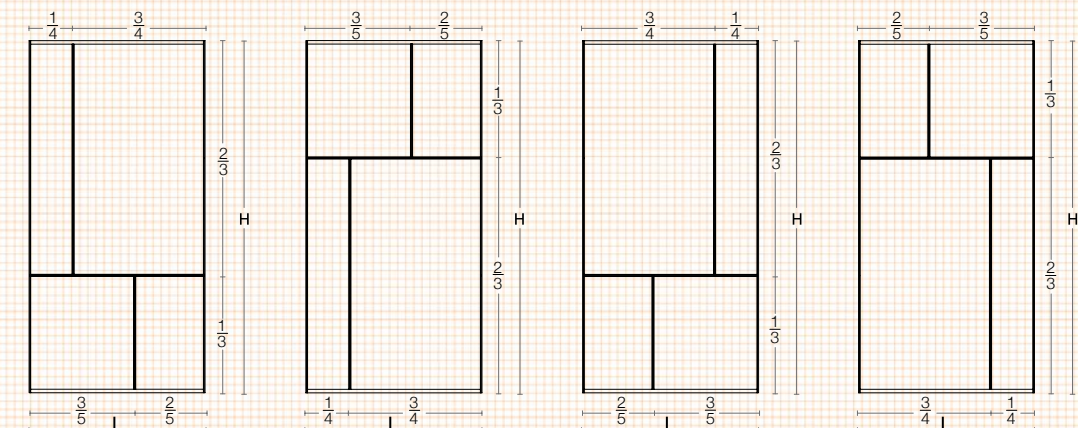

codice / code :
SPO1P05

codice / code :
SPO1P06

codice / code :
SPO1P07

codice / code :
SPO1P08

MANIGLIE SHERAZADE POCKET PATCHWORK / HANDLES SHERAZADE POCKET PATCHWORK

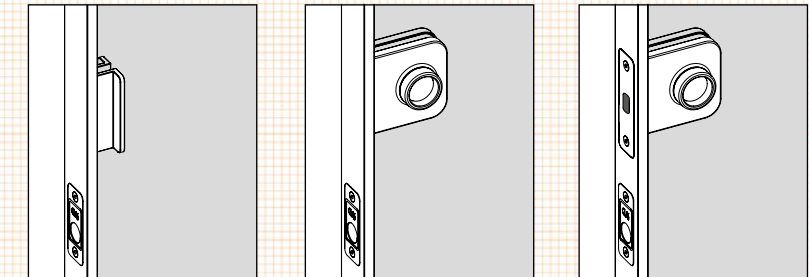

maniglia senza supporto /
handle without support

maniglia con supporto /
handle with support

maniglia con nottolino /
handle with revolving plug

codice / code :
MSSSP

codice / code :
MCSSP

codice / code :
MCNSP

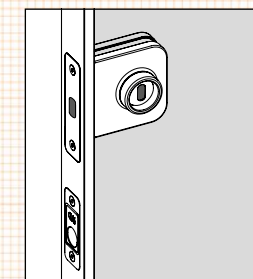

maniglia con chiave /
handle with key lock

codice / code :
MCCSP

Sherazade Double Pocket Patchwork

Design Piero Lissoni

PORTA A SCOMPARSА SENZA STIPITE / POCKET DOOR WITH CONCEALED FRAME

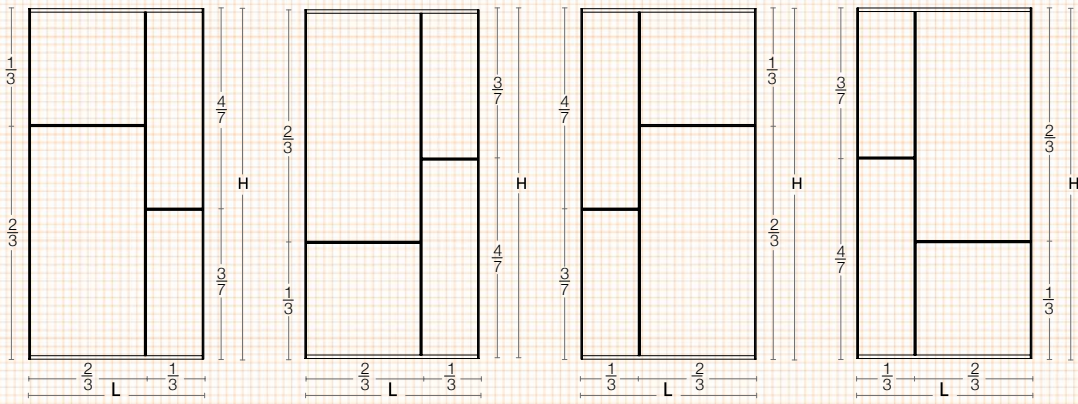
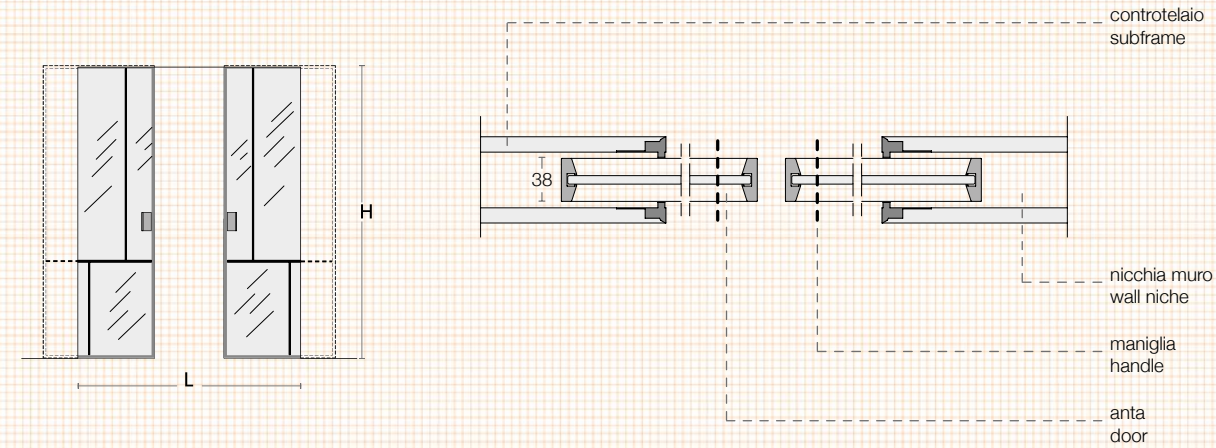

codice / code :
SPO2P01

codice / code :
SPO2P02

codice / code :
SPO2P03

codice / code :
SPO2P04

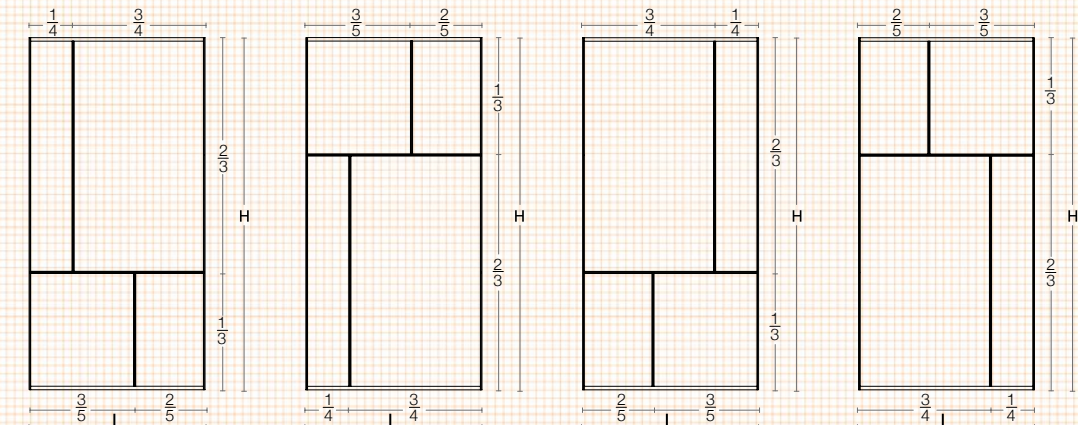

codice / code :
SPO2P05

codice / code :
SPO2P06

codice / code :
SPO2P07

codice / code :
SPO2P08

MANIGLIE SHERAZADE DOUBLE POCKET PATCHWORK / HANDLES SHERAZADE DOUBLE POCKET PATCHWORK

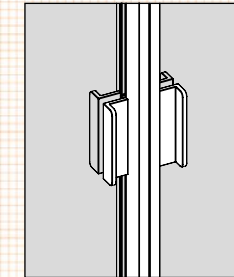

maniglia doppia
senza supporto /
double handle
without support

codice / code :
M2SSSP

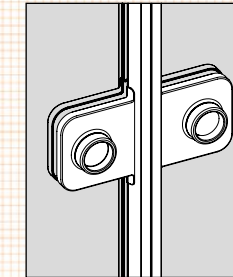

maniglia doppia
con supporto /
double handle
with support

codice / code :
M2CSSP

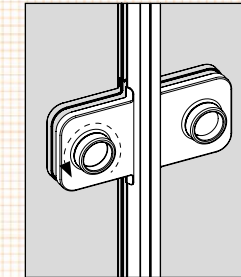

maniglia doppia
con nottolino /
double handle
with revolving plug

codice / code :
M2CNPS

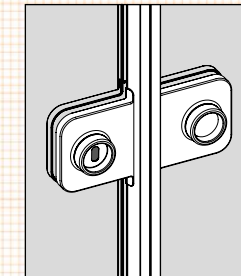

maniglia doppia
con chiave /
double handle
with key lock

codice / code :
M2CCSP

IT

Le ante **Aladin Pocket Mono**, prodotte su misura e perfettamente integrabili nei più diffusi sistemi di porte scorrevoli a scomparsa senza stipite, quali Scrigno Essential® scorrevole ed Eclisse® Syntesis Line, hanno un vetro applicato su un lato del telaio, in modo da avere una faccia con superficie planare e l'altra con superficie arretrata rispetto alla cornice perimetrale d'alluminio disponibile in cinque diverse finiture. Il vetro, disponibile in una vastissima gamma di finiture, può essere monolitico temperato 6 mm oppure stratificato 3 + 3 mm. Tutti i vetri sono certificati secondo le normative di sicurezza ANSI Z97.1 e UNI EN12150. Sono disponibili anche pannelli in gres con diverse finiture.

Le due versioni, ad anta singola e ad anta doppia, possono essere fornite con o senza serratura.

A richiesta vengono forniti anche i controtelai per cartongesso e intonaco.

EN

The **Aladin Pocket Mono** doors are custom-made, can be integrated into the most common systems of frameless sliding pocket doors such as Scrigno Essential® sliding and Eclisse® Syntesis Line and have glass applied on one side of the frame so that one side has a flush surface and the other is rebated from the aluminium frame available in five different finishes. The glass, available in a wide range of finishes, can be monolithic tempered 6 mm as a single piece or laminated 3 + 3 mm. All glasses are certified according to the safety regulation ANSI Z97.1 and UNI EN12150. Panels in stoneware with different finishes are available too. The two versions, with single or double door, can be supplied with or without the lock. Subframes for plasterboard or brick walls can be provided on demand.

FR

Les portes **Aladin Pocket Mono**, produites sur mesure et parfaitement intégrables dans les plus diffuses systèmes de portes coulissantes escamotables sans montant comme Scrigno Essential® coulissant et Eclisse® Syntesis Line, ont un cristal appliqué sur un côté du cadre, de façon à avoir un côté avec surface plane et l'autre côté avec une surface en retrait par rapport au cadre périmétrique en aluminium disponible en cinq finitions différents.

Le cristal, disponible dans une large gamme de finitions, peut être monolithique trempé 6 mm ou stratifié 3 + 3 mm.

Tous les verres sont certifiés selon les normes de sécurité ANSI Z97.1 et UNI EN12150. Panneaux en grès en différentes finitions sont également disponibles. Les deux versions, avec porte simple ou double porte, sont fournies avec ou sans serrure. Sur demande les contre-châssis pour placoplâtre et pour béton sont également fournis.



DE

Aladin Pocket Mono Türen werden nach Maß gefertigt und sind mit den meistverbreiteten Führungsschienensystemen von Schiebe-Taschentüren ohne Pfosten, wie Scrigno Essential® Schiebetür und Eclisse® Syntesis Line kombinierbar. Der umlaufende Aluminiumrahmen ist mit einer einseitigen Glasfüllung versehen, die einseitig bündig mit dem Rahmen abschließt und auf der Gegenseite zurückspringt. Der Rahmen ist in fünf verschiedenen Ausführungen erhältlich. Die Glasfüllung, das in einer sehr breiten Auswahl von Ausführungen verfügbar ist, kann 6 mm stark monolithisch gehärtet oder 3 + 3 mm stark beschichtet sein. Alle Gläser sind gemäß ANSI Z97.1 und UNI EN 12150 zertifiziert. Grespaneele in verschiedenen Ausführungen sind ebenfalls erhältlich. Die zwei Varianten, Einzeltür und Doppeltür, können mit oder ohne Schloss vorhanden sein. Auf Wunsch können Doppelrahmen für Gipskarton- und Betonwände geliefert werden.

ES

Las puertas **Aladin Pocket Mono** son producidas a medida y son perfectamente integrables en los sistemas de puertas correderas empotradas sin jamba más utilizados, como Scrigno Essential® corredera y Eclisse® Syntesis Line. Estos paneles tienen un cristal aplicado en un lado del marco, con el fin de tener una cara con una superficie coplanar y la otra con superficie retraída respecto al marco perimetral de aluminio disponible en cinco diferentes acabados. El cristal, disponible en una amplia gama de acabados, puede ser monolítico templado 6 mm o laminado 3 + 3 mm. Todos los cristales son certificados según las normativas de seguridad ANSI Z97.1 y UNI EN12150. Estàn disponibles también paneles de gres con diferentes acabados. Las dos versiones, con puerta singular o doble, pueden ser suministradas con o sin cerradura. A petición pueden ser suministrados los contramarcos para pladur y ladrillo.

Aladin Pocket Mono

Design Piero Lissoni

PORTA A SCOMPARSA SENZA STIPITE / POCKET DOOR WITH CONCEALED FRAME

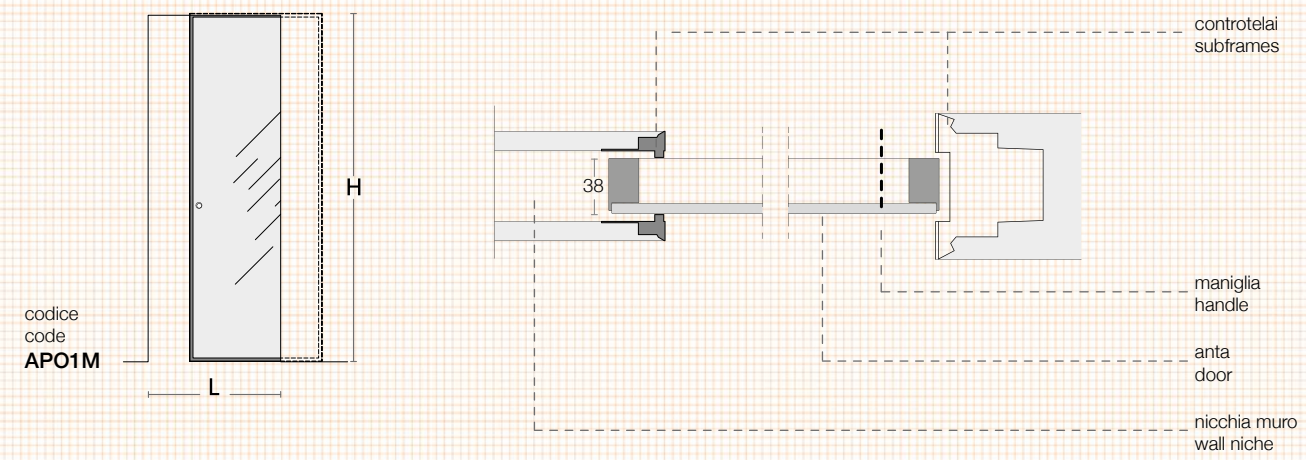

MANIGLIE PANNELLO MONO / HANDLES PANEL MONO

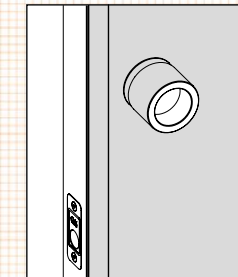

maniglia tonda
senza supporto /
round handle
without support

codice / code :
MSSP

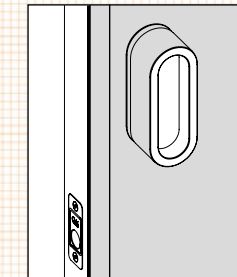

maniglia ovale
senza supporto /
oval handle
without support

codice / code :
MSOP

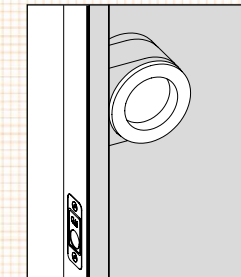

maniglia con supporto /
handle with support

codice / code :
MCSP

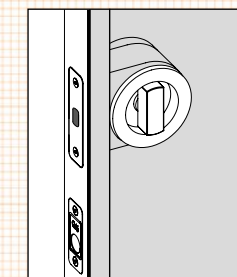

maniglia con nottolino /
handle with revolving plug

codice / code :
MCNP

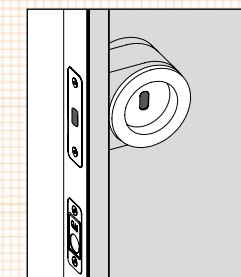

maniglia con chiave /
handle with key lock

codice / code :
MCCP

Aladin Double Pocket Mono

Design Piero Lissoni

PORTA A SCOMPARSA SENZA STIPITE / POCKET DOOR WITH CONCEALED FRAME

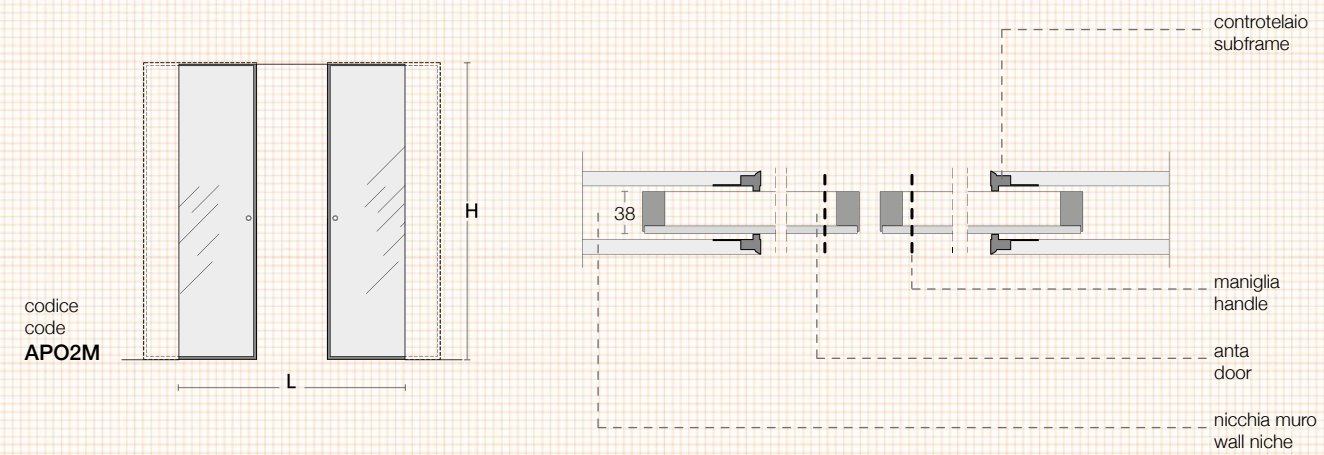

MANIGLIE PORTA A SCOMPARSA ANTA DOPPIA / HANDLES DOUBLE POCKET DOOR

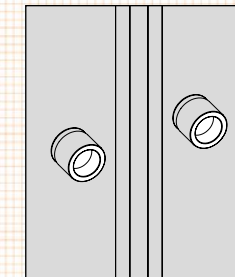

maniglia doppia tonda
senza supporto /
double round handle
without support

codice / code :
M2SSP

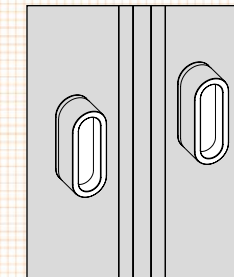

maniglia doppia ovale
senza supporto /
double oval handle
without support

codice / code :
M2SOP

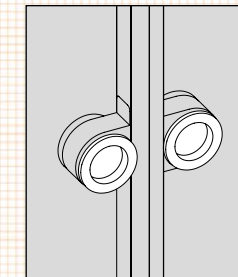

maniglia doppia
con supporto /
double handle
with support

codice / code :
M2CSP

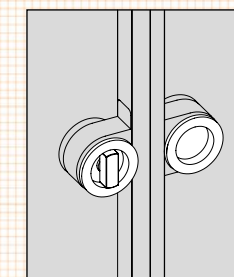

maniglia doppia
con nottolino /
double handle
with revolving plug

codice / code :
M2CNP

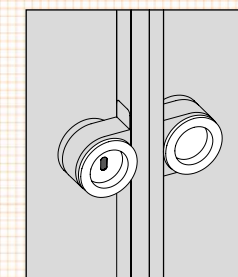

maniglia doppia
con chiave /
double handle
with key lock

codice / code :
M2CCP

IT

Le ante **Aladin Pocket Duo**, prodotte su misura e perfettamente integrabili nei più diffusi sistemi di porte scorrevoli a scomparsa senza stipite, quali Scrigno Essential® scorrevole ed Eclisse® Syntesis Line, hanno vetri temperati spessore 4 mm applicati su entrambe le facce del telaio d'alluminio, disponibile in cinque diverse finiture, in modo da formare un volume con una camera d'aria interna. I vetri, disponibili in un'ampia gamma di finiture, sono certificati secondo le normative di sicurezza ANSI Z97.1 e UNI EN12150. Sono disponibili anche pannelli in gres o in legno, con diverse finiture ed essenze. Le due versioni, ad anta singola e ad anta doppia, possono essere fornite con o senza serratura. A richiesta vengono forniti anche i controtelai per cartongesso e intonaco.

EN

The **Aladin Pocket Duo** doors are custom-made, can be integrated into the most common systems of frameless sliding pocket doors such as Scrigno Essential® sliding and Eclisse® Syntesis Line and have 4 mm thick tempered glass applied on both faces of the aluminium frame, available in five different finishes, so as to form a volume with an internal air chamber. The glasses are available in a wide range of finishes and they are certified according to the safety regulation ANSI Z97.1 and UNI EN12150. Panels in stoneware and in wood with different finishes and essences are available too. The two versions, with single or double door, can be supplied with or without the lock. Subframes for plasterboard or brick walls can be provided on demand.

FR

Les portes **Aladin Pocket Duo**, produites sur mesure et parfaitement intégrables dans les plus diffuses systèmes de portes coulissantes escamotables sans montant, comme Scrigno Essential® coulissant et Eclisse® Syntesis Line, ont des cristaux trempés épaisseur 4 mm appliqués sur les deux côtés du cadre en aluminium, disponible en cinq finitions différents, de manière à former un volume d'air interne. Les verres, disponibles dans une large gamme de finitions, sont certifiés selon les normes de sécurité ANSI Z97.1 et UNI EN12150. Panneaux en grès et bois en différentes finitions et essences sont également disponibles. Les deux versions, avec porte simple ou double porte, sont fournies avec ou sans serrure. Sur demande les contre-châssis pour placoplâtre et pour béton sont également fournis.

**DE**

Aladin Pocket Duo Türen werden nach Maß gefertigt und sind mit den meistverbreiteten Führungsschienensystemen von Schiebe-Taschentüren ohne Pfosten, wie Scrigno Essential® Schiebetür und Eclisse® Syntesis Line kombinierbar. Die beidseitigen Glasfüllungen sind je 4 mm stark und gehärtet. Der Rahmen ist in fünf verschiedenen Ausführungen erhältlich. Zwischen den Füllungen befindet sich einen Luftraum. Die Gläser, die in einer Vielzahl von Ausführungen erhältlich sind, sind gemäß ANSI Z97.1 e UNI EN12150 zertifiziert. Gres-und Holzpaneele in verschiedenen Ausführungen und Hölzern sind ebenfalls erhältlich. Die zwei Varianten, Einzeltür und Doppeltür, können mit oder ohne Schloss vorhanden sein. Auf Wunsch können Doppelrahmen für Gipskarton-und Betonwände geliefert werden.

ES

Las puertas **Aladin Pocket Duo** son producidas a medida y son perfectamente integrables en los sistemas de puertas correderas empotradas sin jamba más utilizados, como Scrigno Essential® corredera y Eclisse® Syntesis Line. Estos paneles tienen cristales templados de 4 mm de espesor y están aplicados en ambas caras del marco de aluminio, disponible en cinco diferentes acabados, con el fin de crear un volumen con una cámara de aire interna. Los cristales, disponibles en una amplia gama de acabados, son certificados según las normativas de de seguridad ANSI Z97.1 y UNI EN12150. Están disponibles también paneles de gres y madera con diferentes acabados y esencias. Las dos versiones, con puerta singular o doble, pueden ser suministradas con o sin cerradura. A petición pueden ser suministrados los contramarcos para pladur y ladrillo.

Aladin Pocket Duo

Design Piero Lissoni

PORTA SCOMPARSA SENZA STIPITE / POCKET DOOR WITH CONCEALED FRAME

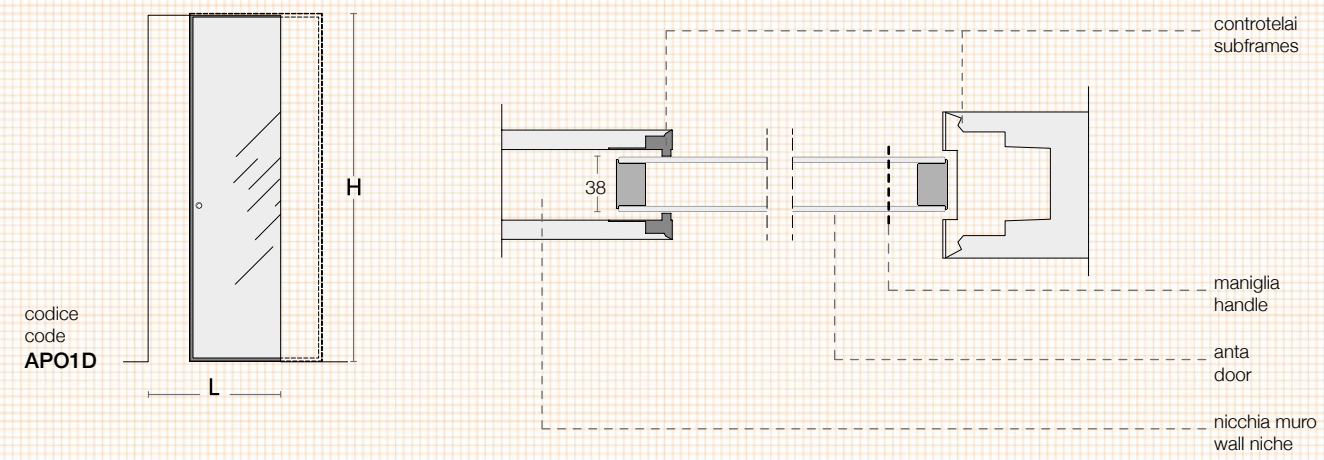

MANIGLIE PANNELLO DUO / HANDLES PANEL DUO

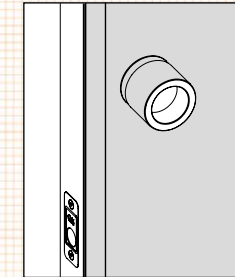

maniglia tonda
senza supporto /
round handle
without support

codice / code :
MSSP

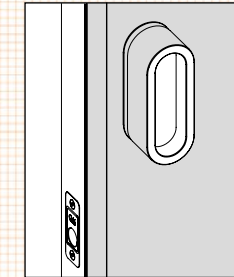

maniglia ovale senza supporto /
oval handle without support

codice / code :
MSOP

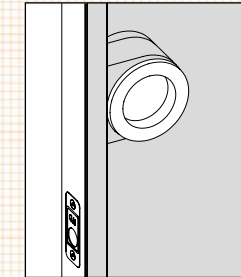

maniglia con supporto /
handle with support

codice / code :
MCSP

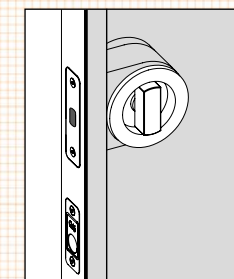

maniglia con nottolino /
handle with revolving plug

codice / code :
MCNP

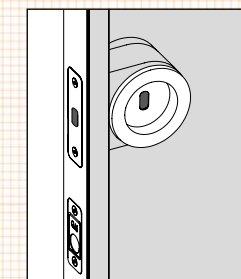

maniglia con chiave /
handle with key lock

codice / code :
MCCP

Aladin Double Pocket Duo

Design Piero Lissoni

PORTA SCOMPARSA SENZA STIPITE / POCKET DOOR WITH CONCEALED FRAME

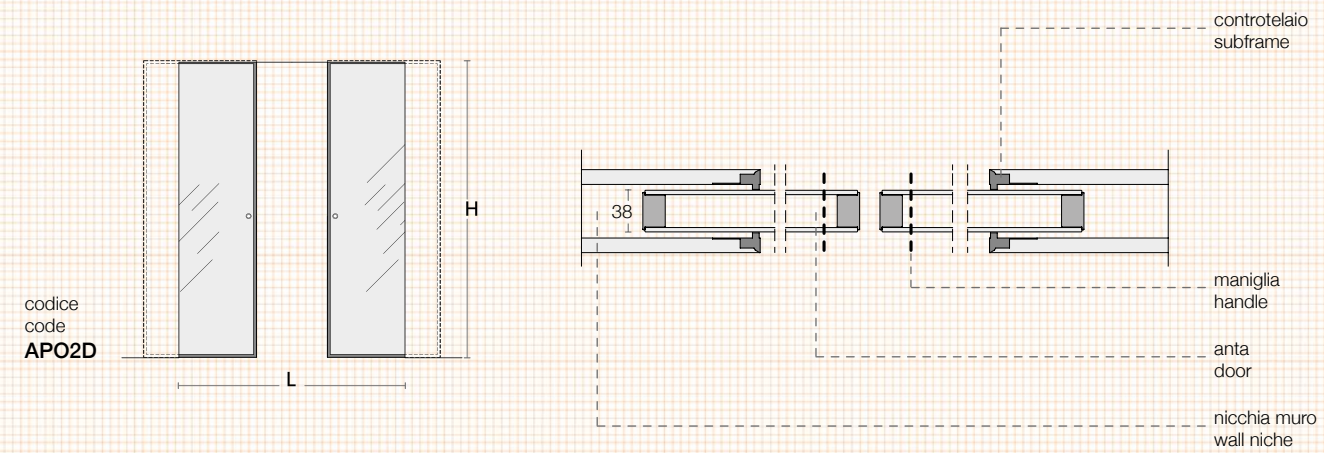

MANIGLIE PORTA A SCOMPARSA ANTA DOPPIA / HANDLES DOUBLE POCKET DOOR

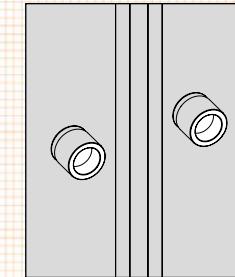

maniglia doppia tonda
senza supporto /
double round handle
without support

codice / code :
M2SSP

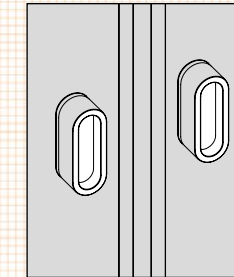

maniglia doppia ovale
senza supporto /
double oval handle
without support

codice / code :
M2SOP

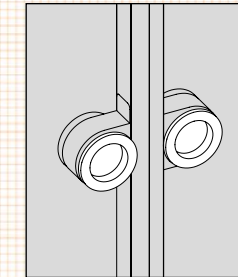

maniglia doppia
con supporto /
double handle
with support

codice / code :
M2CSP

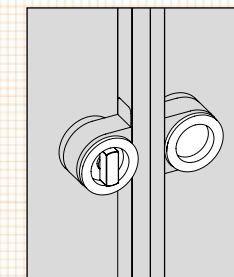

maniglia doppia
con nottolino /
double handle
with revolving plug

codice / code :
M2CNP

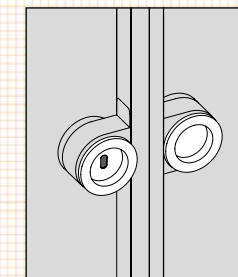

maniglia doppia
con chiave /
double handle
with key lock

codice / code :
M2CCP

IT

Le ante **Sherazade Pocket Frame**, prodotte su misura e perfettamente integrabili nei più diffusi sistemi di porte scorrevoli a scomparsa con stipite hanno un vetro temperato monolitico da 6 mm o stratificato 3 + 3 mm inserito tramite una guarnizione al centro di un telaio d'alluminio, fornito in cinque diverse finiture.

La porta viene fornita completa di stipite telescopico in alluminio per pareti con spessore da 90 a 130 mm nella stessa finitura del telaio dell'anta. I vetri, disponibili in una vastissima gamma di finiture, sono certificati secondo le normative di sicurezza ANSI Z97.1 e UNI ENI 2150 (ad eccezione di 533. armato). Sono disponibili anche pannelli in gres o in legno, con diverse finiture ed essenze. Le due versioni ad anta singola e ad anta doppia possono essere fornite con o senza serratura. A richiesta vengono forniti anche i controtelai per cartongesso e intonaco.



EN

The **Sherazade Pocket Frame** doors are custom-made, can be integrated into the most common systems of sliding pocket doors with jamb and have a monolithic 6 mm or laminated glass 3 + 3 mm thick tempered glass inserted by means of a seal in the center of the aluminum frame, which is supplied in five different finishes.

The door is supplied with telescopic aluminum jambs, for walls with thickness from 90 up to 130 mm, in the same finish as the door frame. The glass, available in a wide range of finishes are certified according to the safety regulation ANSI Z97.1 and UNI EN12150 (with the exception of 533. armato). Panels in stoneware and in wood with different finishes and essences are available too. The two versions, with single or double door, can be provided with or without lock. Subframes for plasterboard or brick walls can be provided on demand.

FR

Les portes **Sherazade Pocket Frame**, produites sur mesure et parfaitement intégrables dans les plus diffuses systèmes de portes coulissantes à galandage avec montant ont un verre monolithique trempé 6 mm ou stratifié 3 + 3 mm inséré par un joint au milieu de un cadre en aluminium, fourni en cinq finitions différents.

La porte est fournie avec un montant télescopique en aluminium, pour parois avec épaisseur de 90 a 130 mm dans la meme finition que le cadre de la porte. Les verres sont disponibles dans une large gamme de finitions, ils sont certifiés selon les normes de sécurité ANSI Z97.1 et UNI ENI 2150 (à l'exception de la finition 533. armato).

Panneaux en grès et bois en différentes finitions et essences sont également disponibles.

Les deux versions, avec porte simple ou double porte sont fournies avec ou sans serrure.

Sur demande les contre-châssis pour Placoplâtre et pour béton sont fournis.

DE

Die **Sherazade Pocket Frame** Türen mit Pfosten werden nach Maß hergestellt und sind mit den meistverbreiteten Führungsschienensystemen von rahmenlosen Schiebe-Taschentüren kombinierbar. Das Glas kann 6 mm. stark monolithisch gehärtet oder 3 + 3 mm stark beschichtet sein und es ist mittels einer Dichtung in der Mitte eines Aluminiumrahmens eingesetzt, der in fünf verschiedenen Ausführungen erhältlich ist. Die Tür wird mit teleskopischen Pfosten aus Aluminium geliefert, der für Wände mit Stärke zwischen 90 und 130 mm verwendbar ist. Die Ausführung ist dieselbe des Rahmens. Die Gläser, die in einer Vielzahl von Ausführungen erhältlich sind, sind gemäß ANSI Z97.1 und UNI ENI 2150 zertifiziert (außer für die Ausführung 533. armato). Gres-und Holzpaneele in verschiedenen Ausführungen und Hölzern sind ebenfalls erhältlich. Die zwei Varianten, Einzeltür und Doppeltür, können mit oder ohne Schloss vorhanden sein. Auf Wunsch können Doppelrahmen für Gipskarton-und Betonwände geliefert werden.

ES

Las puertas **Sherazade Pocket Frame** son producidas a medida y son perfectamente integrables en los sistemas de puertas correderas empotradas más utilizados con jamba. Estos paneles tienen un cristal monolítico de 6 mm o estratificado 3 + 3 mm está insertado por medio de una junta en el centro del marco de aluminio, suministrado en cinco diferentes acabados. La puerta está equipada completa de la jamba telescópica en aluminio para paredes con espesor de mm 90 a 130 en el mismo acabado del marco de la puerta. Los cristales, disponibles en una amplia gama de acabados, son certificados según las normativas de seguridad ANSI Z97.1 y UNI ENI 2150 (a excepción de 533. armato). Están disponibles también paneles de gres y madera con diferentes acabados y esencias.

Las dos versiones, con puerta simple o doble, pueden ser suministradas con o sin cerradura.

A petición pueden ser suministrados los contramarcos para pladur y ladrillo.

Sherazade Pocket Frame

Design Piero Lissoni

PORTA SCOMPARSA CON STIPITE / POCKET DOOR WITH VISIBLE FRAME

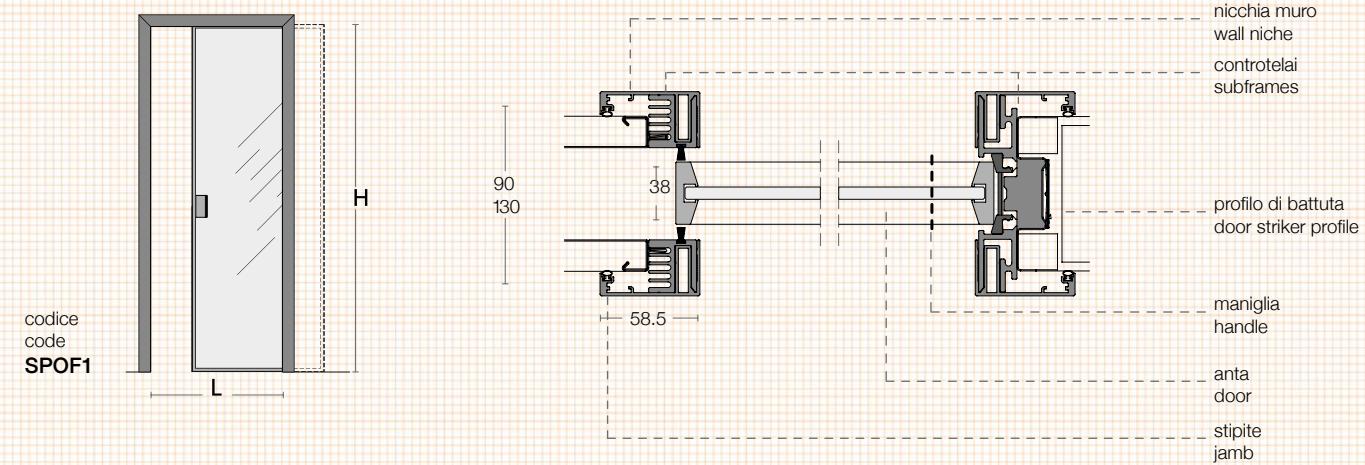

MANIGLIE SHERAZADE POCKET FRAME / HANDLES SHERAZADE POCKET FRAME

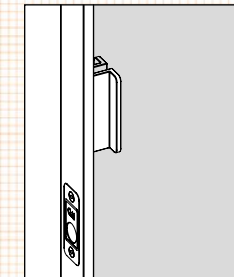

maniglia senza supporto /
handle without support

codice / code :
MSSSP

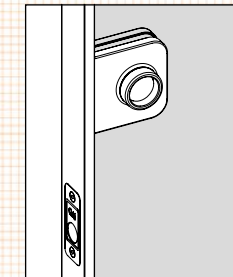

maniglia con supporto /
handle with support

codice / code :
MCSSP

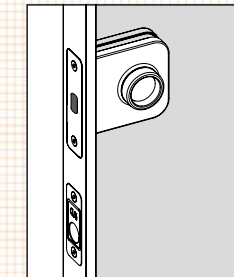

maniglia con nottolino /
handle with revolving plug

codice / code :
MCNSP

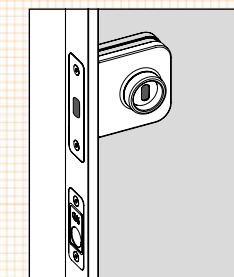

maniglia con chiave /
handle with key lock

codice / code :
MCCSP

Sherazade Double Pocket Frame

Design Piero Lissoni

PORTA SCOMPARSA CON STIPITE / POCKET DOOR WITH VISIBLE FRAME

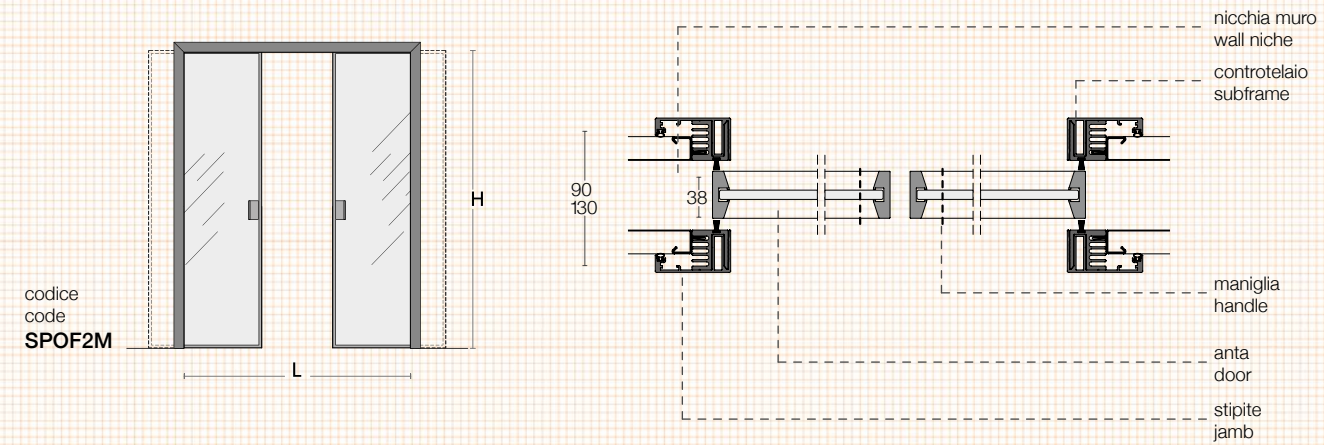

MANIGLIE SHERAZADE DOUBLE POCKET FRAME / HANDLES SHERAZADE DOUBLE POCKET FRAME

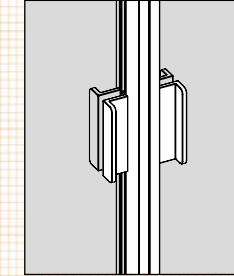

maniglia doppia
senza supporto /
double handle
without support

codice / code :
M2SSSP

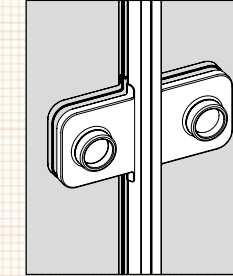

maniglia doppia
con supporto /
double handle
with support

codice / code :
M2CSSP

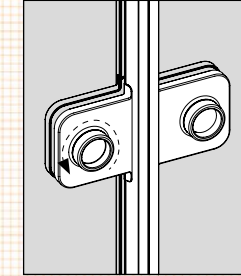

maniglia doppia
con nottolino /
double handle
with revolving plug

codice / code :
M2CNSP

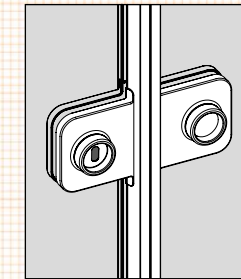

maniglia doppia
con chiave /
double handle
with key lock

codice / code :
M2CCSP

IT

Le ante **Sherazade Pocket Frame Patchwork**, con le medesime caratteristiche di Sherazade Slide Patchwork, sono prodotte su misura e perfettamente integrabili nei più diffusi sistemi di porte scorrevoli a scomparsa con stipite. La porta viene fornita completa di stipite telescopico in alluminio per pareti con spessore da 90 a 130 mm nella stessa finitura del telaio dell'anta. Le due versioni ad anta singola e ad anta doppia possono essere fornite con o senza serratura. A richiesta vengono forniti anche i controtelai per cartongesso e intonaco.

**EN**

The **Sherazade Pocket Frame Patchwork** doors, with the same features as Sherazade Slide Patchwork, are custom-made and can be integrated into the most common sliding pocket door systems with jamb. The door is supplied with a telescopic aluminum jamb for walls with a thickness from 90 to 130 mm, in the same finish as the door frame. The two versions, single or double door, can be supplied with or without lock. Subframes for plasterboard or brick walls are available on demand.

DE

Die **Sherazade Pocket Frame Patchwork** Türen sind durch dieselben Eigenschaften von Sherazade Slide Patchwork gekennzeichnet. Sie werden nach Maß hergestellt sind mit den meistverbreiteten Führungsschienensystemen von Schiebe-Taschentüren mit Pfosten kombinierbar. Die Tür wird mit teleskopischen Pfosten aus Aluminium geliefert, der für Wände mit Stärke zwischen 90 und 130 mm verwendbar ist. Die Ausführung ist dieselbe des Rahmens. Die zwei Varianten, Einzeltür und Doppeltür, können mit oder ohne Schloss vorhanden sein. Auf Wunsch können Doppelrahmen für Gipskarton- und Betonwände geliefert werden.

FR

Les portes **Sherazade Pocket Frame Patchwork**, avec les mêmes caractéristiques que Sherazade Slide Patchwork, sont produites sur mesure et sont parfaitement intégrables dans les plus diffusés systèmes de portes coulissantes à galandage avec montant. La porte est livrée complète avec un montant télescopique en aluminium pour des murs d'une épaisseur de 90 à 130 mm dans la même finition que le cadre de la porte. Les deux versions avec porte simple et double porte peuvent être fournies avec ou sans serrure. Sur demande, les contrechâssis pour placoplâtre et pour béton sont fournis.

ES

Las puertas **Sherazade Pocket Frame Patchwork**, con las mismas características de Sherazade Slide Patchwork, son producidas a medida y son perfectamente integrables en los sistemas de puertas correderas empotradas con jamba más utilizados. La puerta está suministrada con una jamba telescópica de aluminio con espesor de 90 a 130 mm en el mismo acabado del marco de la puerta. Las dos versiones, con puerta simple o doble, pueden ser suministradas con o sin cerradura. A petición pueden ser suministrados los contramarcos para pladur y ladrillo.

Sherazade Pocket Frame Patchwork

Design Piero Lissoni

PORTA SCOMPARSA CON STIPITE / POCKET DOOR WITH VISIBLE FRAME

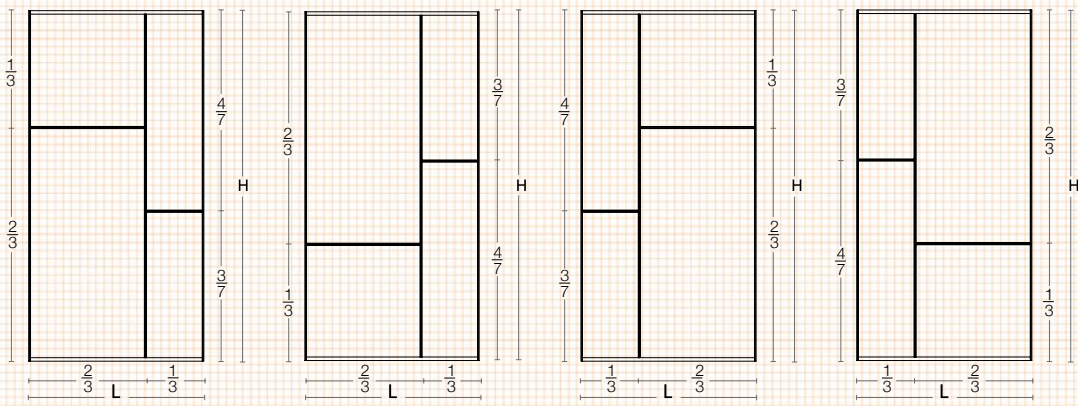
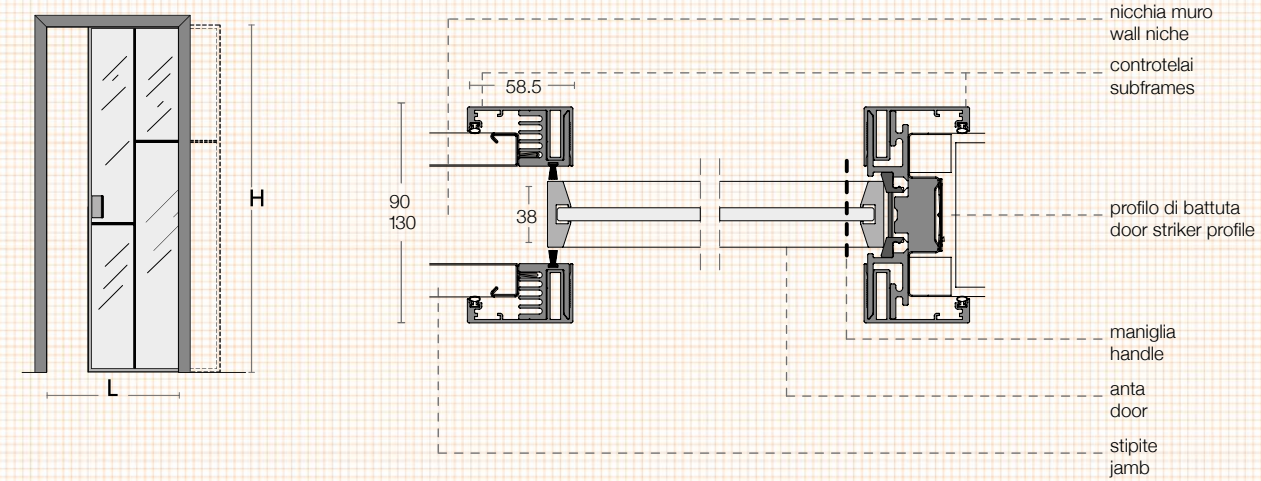

codice / code :
SPOF1P01

codice / code :
SPOF1P02

codice / code :
SPOF1P03

codice / code :
SPOF1P04

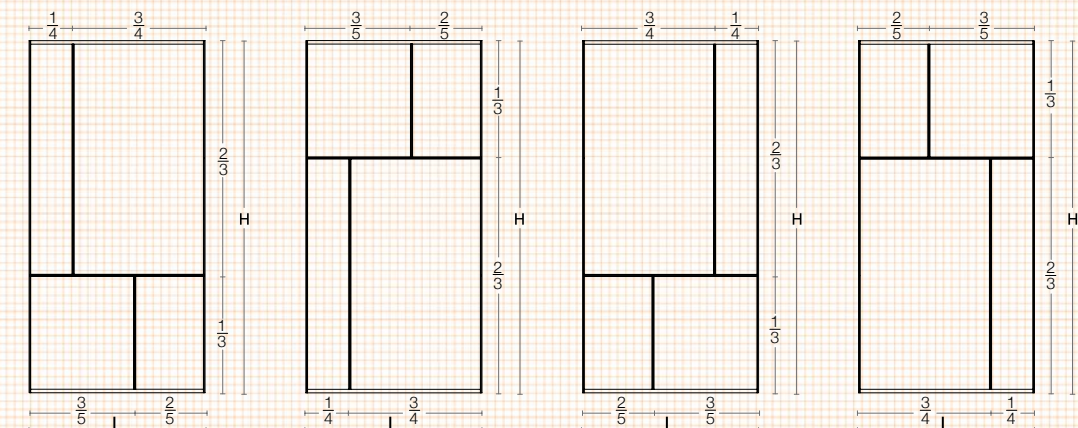

codice / code :
SPOF1P05

codice / code :
SPOF1P06

codice / code :
SPOF1P07

codice / code :
SPOF1P08

MANIGLIE SHERAZADE POCKET FRAME PATCHWORK / HANDLES SHERAZADE POCKET FRAME PATCHWORK

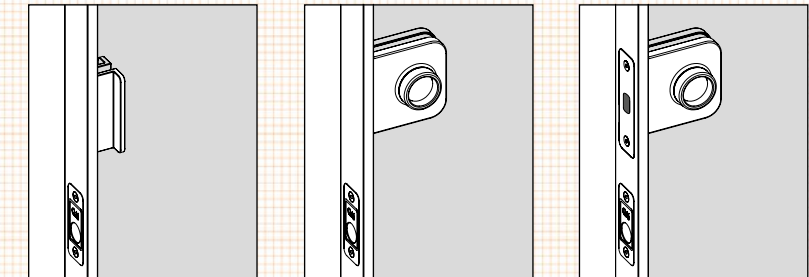

maniglia senza supporto /
handle without support

maniglia con supporto /
handle with support

maniglia con nottolino /
handle with revolving plug

codice / code :
MSSSP

codice / code :
MCSSP

codice / code :
MCNSP

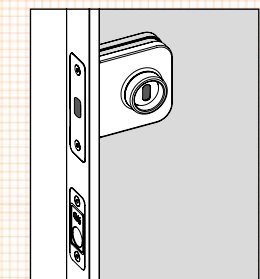

maniglia con chiave /
handle with key lock

codice / code :
MCCSP

Sherazade Double Pocket Frame Patchwork

Design Piero Lissoni

PORTA SCOMPARSA CON STIPITE / POCKET DOOR WITH VISIBLE FRAME

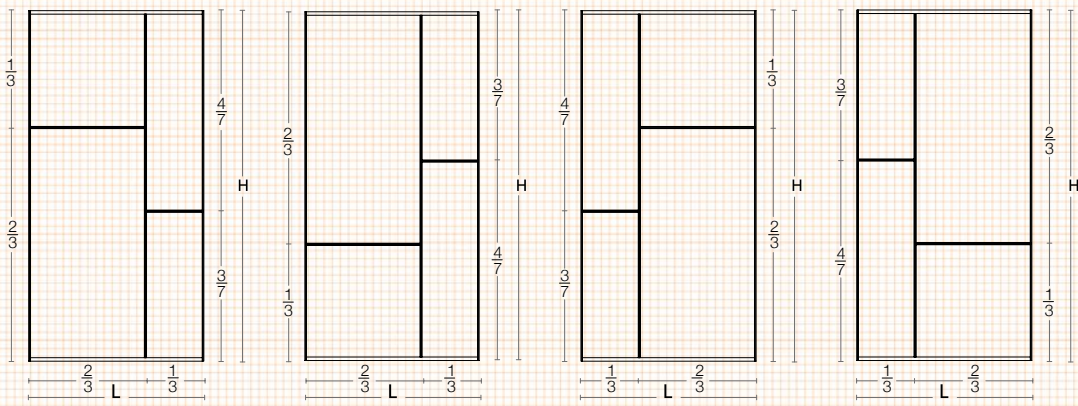
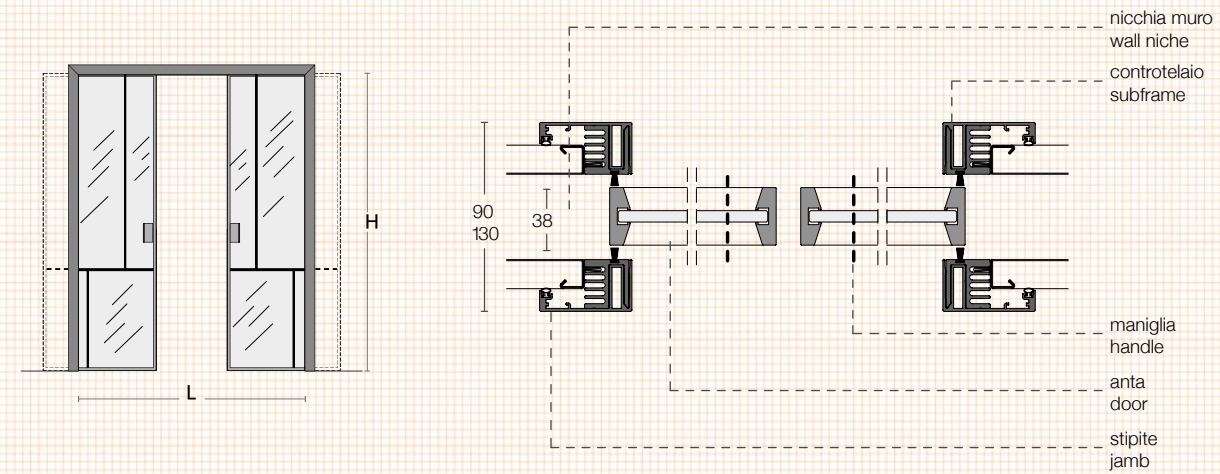

codice / code :
SPOF2P01

codice / code :
SPOF2P02

codice / code :
SPOF2P03

codice / code :
SPOF2P04

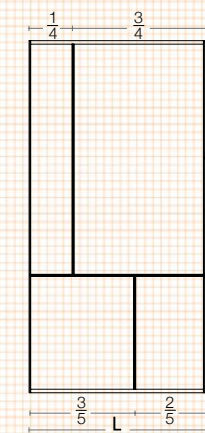

codice / code :
SPOF2P05

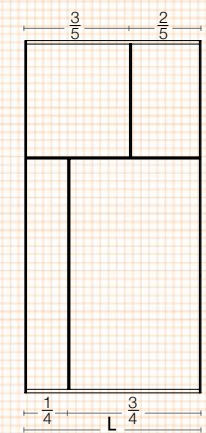

codice / code :
SPOF2P06

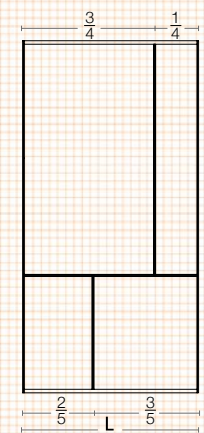

codice / code :
SPOF2P07

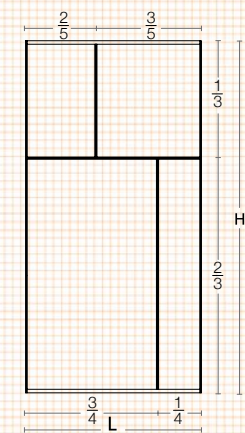

codice / code :
SPOF2P08

MANIGLIE SHERAZADE DOUBLE POCKET FRAME PATCHWORK / HANDLES SHERAZADE DOUBLE POCKET FRAME PATCHWORK

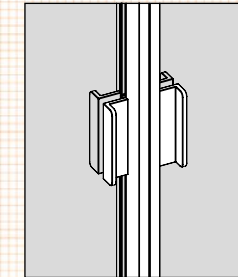

maniglia doppia
senza supporto /
double handle
without support

codice / code :
M2SSSP

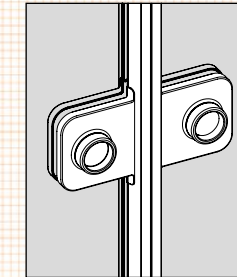

maniglia doppia
con supporto /
double handle
with support

codice / code :
M2CSSP

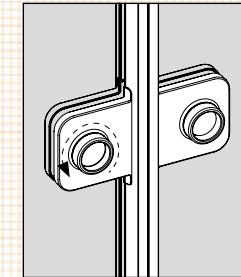

maniglia doppia
con nottolino /
double handle
with revolving plug

codice / code :
M2CNSP

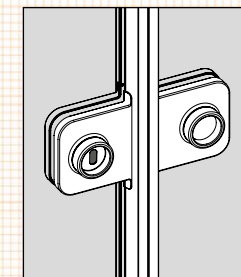

maniglia doppia
con chiave /
double handle
with key lock

codice / code :
M2CCSP

IT

Le ante **Aladin Pocket Frame Mono**, prodotte su misura e perfettamente integrabili nei più diffusi sistemi di porte scorrevoli a scomparsa con stipite, hanno un vetro applicato su un lato del telaio, in modo da avere una faccia con superficie planare e l'altra con superficie arretrata rispetto alla cornice perimetrale d'alluminio disponibile in cinque diverse finiture. Il vetro, disponibile in una vastissima gamma di finiture, può essere monolitico temperato 6 mm oppure stratificato 3 + 3 mm.

Tutti i vetri sono certificati secondo le normative di sicurezza ANSI Z97.1 e UNI EN12150. Sono disponibili anche pannelli in gres con diverse finiture. La porta viene fornita completa di stipite telescopico in alluminio per pareti con spessore da 90 a 130 mm nella stessa finitura del telaio dell'anta. Per dimensioni maggiori devono essere considerati gli extra prezzi indicati. Le due versioni, ad anta singola e ad anta doppia, possono essere fornite con o senza serratura. A richiesta vengono forniti anche i controtelai per cartongesso e intonaco.

EN

The **Aladin Pocket Frame Mono** doors are custom-made, can be integrated into the most common systems of sliding pocket doors with jamb and have a glass applied on one side of the frame so that one side has a flush surface whilst the other is rebated from the aluminium frame available in five different finishes. The glass, available in a wide range of finishes, can be monolithic tempered 6 mm as a single piece or laminated 3 + 3 mm. All glasses are certified according to the safety regulation ANSI Z97.1 and UNI EN12150. Panels in stoneware with different finishes are available too. The door is supplied with telescopic aluminium jambs, for walls with thickness from 90 up to 130 mm, in the same finish as the door frame. For larger dimensions, additional costs as specified must be taken into consideration. The two versions, with single or double door, can be provided with or without lock. Subframes for plasterboard or brick walls can be provided on demand.

FR

Les portes **Aladin Pocket Frame Mono**, produites sur mesure et parfaitement intégrables dans les plus diffuses systèmes de portes coulissantes escamotables avec montant, ont un cristal appliqué sur un côté du cadre, de façon à avoir un côté avec surface plane et l'autre côté avec une surface en retrait par rapport au cadre périmétrique en aluminium disponible en cinq finitions différents. Le cristal, disponible dans une large gamme de finitions, peut être monolithique trempé 6 mm ou stratifié 3 + 3 mm. Tous les verres sont certifiés selon les normes de sécurité ANSI Z97.1 et UNI EN12150. Panneaux en grès en différentes finitions sont également disponibles.

La porte est fournie avec un montant télescopique en aluminium, pour parois avec épaisseur de 90 à 130 mm, dans la même finition que le cadre de la porte. En cas de dimensions plus grandes, merci de consulter les prix supplémentaires indiqués. Les deux versions, avec porte simple ou double porte, sont fournies avec ou sans serrure. Sur demande les contre-châssis pour placoplâtre et pour béton sont également fournis.



DE

Die **Aladin Pocket Frame Mono** Türen mit Pfosten werden nach Maß hergestellt und sind mit den meistverbreiteten Führungsschienensystemen von Schiebe-Taschentüren kombinierbar. Der umlaufende Aluminiumrahmen ist mit einer einseitigen Glasfüllung versehen, die einseitig bündig mit dem Rahmen abschließt und auf der Gegenseite zurückspringt. Der Rahmen ist in fünf verschiedenen Ausführungen erhältlich.

Die Glasfüllung, die in einer sehr weiten Auswahl von Ausführungen verfügbar ist, kann 6 mm stark monolithisch gehärtet oder 3 + 3 mm stark beschichtet sein. Alle Gläser sind gemäß ANSI Z97.1 und UNI EN 12150 zertifiziert. Grespaneele in verschiedenen Ausführungen sind ebenfalls erhältlich. Die Tür wird mit teleskopischen Pfosten aus Aluminium geliefert, der für Wände mit Stärke zwischen 90 und 130 mm verwendbar ist.

Die Ausführung ist dieselbe des Rahmens. Für abweichende Dimensionen muss man die angegebene Extrapreise nachschlagen. Die zwei Varianten, Einzeltür und Doppeltür, können mit oder ohne Schloss vorhanden sein. Auf Wunsch können Doppelrahmen für Gipskarton- und Betonwände geliefert werden.

ES

Las puertas **Aladin Pocket Frame Mono** son producidas a medida y son perfectamente integrables en los sistemas de puertas correderas empotradas con jamba más utilizados. Estos paneles tienen un cristal aplicado en un lado del marco, con el fin de tener una cara con una superficie coplanar y la otra con superficie retraída respecto al marco perimetral de aluminio disponible en cinco diferentes acabados. El cristal, disponible en una amplia gama de acabados, puede ser monolítico templado 6 mm o laminado 3 + 3 mm. Todos los cristales son certificados según las normativas de seguridad ANSI Z97.1 y UNI EN12150. Están disponibles también paneles de gres con diferentes acabados. La puerta está equipada completa de la jamba telescópica en aluminio para paredes con espesor de mm 90 a 130 en el mismo acabado del marco de la puerta. Para medidas mayores se deben considerar los precios extras indicados. Las dos versiones, con puerta singular o doble, pueden ser suministradas con o sin cerradura. A petición pueden ser suministrados los contramarcos para pladur y ladrillo.

Aladin Pocket Frame Mono

Design Piero Lissoni

PORTA SCOMPARSA CON STIPITE / POCKET DOOR WITH VISIBLE FRAME

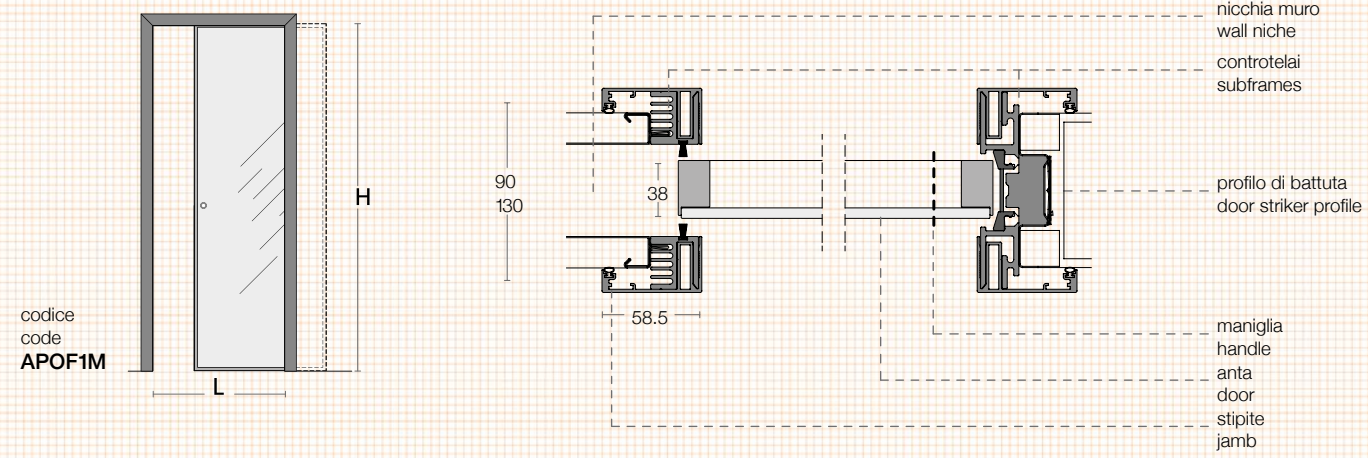

MANIGLIE PANNELLO MONO / HANDLES PANEL MONO

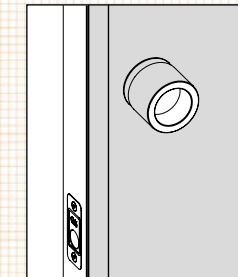

maniglia tonda
senza supporto /
round handle
without support

codice / code :
MSSP

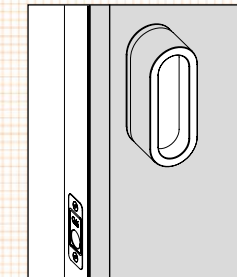

maniglia ovale senza supporto /
oval handle without support

codice / code :
MSOP

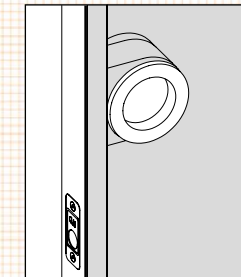

maniglia con supporto /
handle with support

codice / code :
MCSP

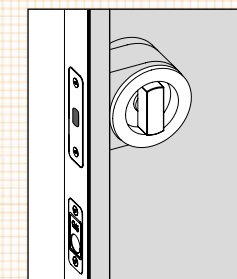

maniglia con nottolino /
handle with revolving plug

codice / code :
MCNP

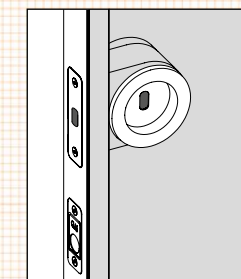

maniglia con chiave /
handle with key lock

codice / code :
MCCP

Aladin Double Pocket Frame Mono

Design Piero Lissoni

PORTA SCOMPARSA CON STIPITE / POCKET DOOR WITH VISIBLE FRAME

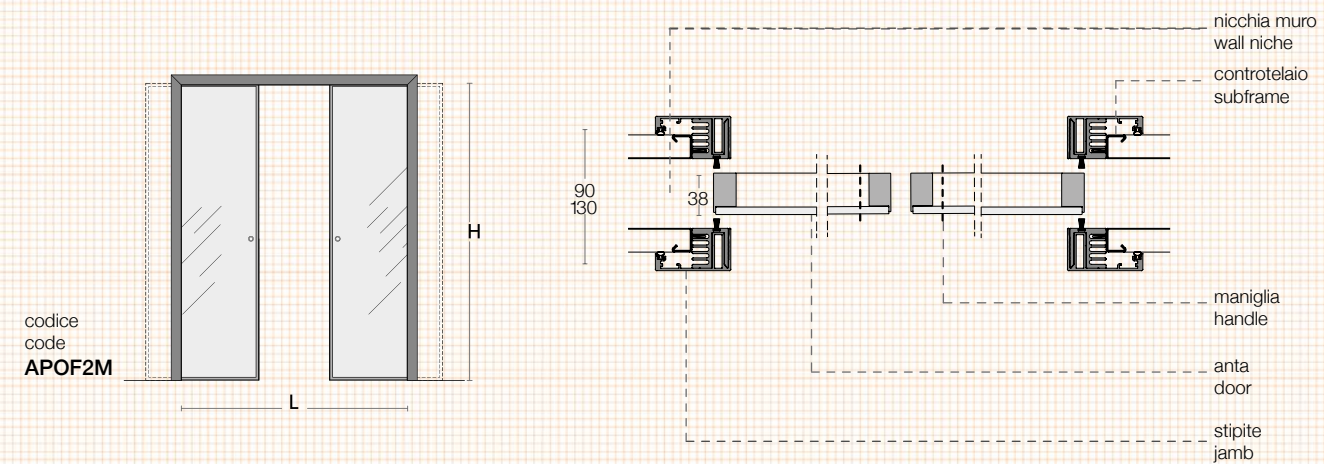

MANIGLIE PORTA A SCOMPARSA ANTA DOPPIA / HANDLES DOUBLE POCKET DOOR

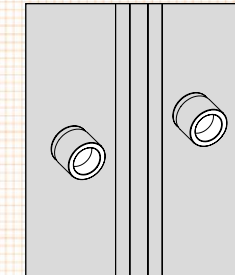

maniglia doppia tonda
senza supporto /
double round handle
without support

codice / code :
M2SSP

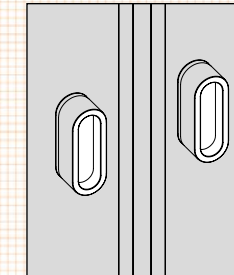

maniglia doppia ovale
senza supporto /
double oval handle
without support

codice / code :
M2SOP

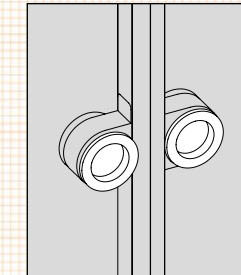

maniglia doppia
con supporto /
double handle
with support

codice / code :
M2CSP

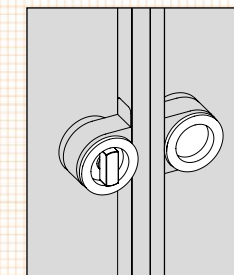

maniglia doppia
con nottolino /
double handle
with revolving plug

codice / code :
M2CNP

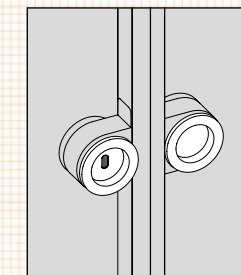

maniglia doppia
con chiave /
double handle
with key lock

codice / code :
M2CCP

IT

Le ante **Aladin Pocket Frame Duo**, prodotte su misura e perfettamente integrabili nei più diffusi sistemi di porte scorrevoli a scomparsa con stipite, hanno vetri temperati spessore 4 mm applicati su entrambe le facce del telaio d'alluminio, disponibile in cinque diverse finiture, in modo da formare un volume con una camera d'aria interna. La porta viene fornita completa di stipite telescopico in alluminio per pareti con spessore da 90 a 130 mm nella stessa finitura del telaio dell'anta. Per dimensioni maggiori devono essere considerati gli extra prezzi indicati. I vetri, disponibili in un'ampia gamma di finiture, sono certificati secondo le normative di sicurezza ANSI Z97.1 e UNI EN12150. Sono disponibili anche pannelli in gres o in legno, con diverse finiture ed essenze. Le due versioni, ad anta singola e ad anta doppia, possono essere fornite con o senza serratura. A richiesta vengono forniti anche i controtelai per cartongesso e intonaco.

EN

The **Aladin Pocket Frame Duo** doors are custom-made, can be integrated into the most common pocket systems of sliding pocket doors with jamb and have 4 mm thick tempered glass applied on both faces of the aluminium frame, available in five different finishes, so as to form a volume with an internal air chamber. The door is supplied with telescopic aluminium jambs, for walls with thickness from 90 up to 130 mm, in the same finish as the door frame. For larger dimensions, additional costs as specified must be taken into consideration. The glasses are available in a wide range of finishes and they are certified according to the safety regulation ANSI Z97.1 and UNI EN12150. Panels in stoneware and in wood with different finishes and essences are available too. The two versions, with single or double door, can be provided with or without lock. Subframes for plasterboard or brick walls can be provided on demand.

FR

Les portes **Aladin Pocket Frame Duo**, produites sur mesure et parfaitement intégrables dans les plus diffuses systèmes de portes coulissantes escamotables avec montant, ont des cristaux trempés épaisseur 4 mm appliqués sur les deux côtés du cadre en aluminium, disponible en cinq finitions différents, de manière à former un volume d'air interne. La porte est fournie avec un montant télescopique en aluminium, pour parois avec épaisseur de 90 à 130 mm, dans la même finition que le cadre de la porte. En cas de dimensions plus grandes, merci de consulter les prix supplémentaires indiqués. Les verres, disponibles dans une large gamme de finitions, sont certifiés selon les normes de sécurité ANSI Z97.1 et UNI EN12150. Panneaux en grès et bois en différentes finitions et essences sont également disponibles. Les deux versions, avec porte simple ou double porte, sont disponibles avec ou sans serrure. Sur demande les contre-châssis pour placoplâtre et pour béton sont également fournis.

**DE**

Die **Aladin Pocket Frame Duo** Türen mit Pfosten werden nach Maß hergestellt und sind mit den meistverbreiteten Führungsschienensystemen von Schiebe-Taschentüren kombinierbar. Die beidseitigen Glasfüllungen sind je 4 mm stark und gehärtet. Der Rahmen ist in fünf verschiedenen Ausführungen erhältlich. Zwischen den Füllungen befindet sich einen Luftraum. Die Tür wird mit teleskopischen Pfosten aus Aluminium geliefert, der für Wände mit Stärke zwischen 90 und 180 mm verwendbar ist. Die Ausführung ist dieselbe des Rahmens. Für abweichende Dimensionen muss man die angegebene Extrapreise nachschlagen. Die Gläser, die in einer Vielzahl von Ausführungen erhältlich sind, sind gemäß ANSI Z97.1 e UNI EN12150 zertifiziert. Gres-und Holzpaneele in verschiedenen Ausführungen und Hölzern sind ebenfalls erhältlich. Die zwei Varianten, Einzeltür und Doppeltür, können mit oder ohne Schloss vorhanden sein. Auf Wunsch können Doppelrahmen für Gipskarton-und Betonwände geliefert werden.

ES

Las puertas **Aladin Pocket Frame Duo** son producidas a medida y son perfectamente integrables en los sistemas de puertas correderas empotradas con jamba más utilizadas. Estos paneles tienen cristales templados de 4 mm de espesor y están aplicados en ambas caras del marco de aluminio, disponible en cinco diferentes acabados, con el fin de crear un volumen con una cámara de aire interna. La puerta está equipada completa de la jamba telescópica en aluminio para paredes con espesor de mm 90 a 130 en el mismo acabado del marco de la puerta. Para medidas mayores se deben considerar los precios extra indicados. Los cristales, disponibles en una amplia gama de acabados, son certificados según las normativas de de seguridad ANSI Z97.1 y UNI EN12150. Están disponibles también paneles de gres y madera con diferentes acabados y esencias. Las dos versiones, con puerta simple o doble, pueden ser suministradas con o sin cerradura. A petición pueden ser suministrados los contramarcos para pladur y ladrillo.

Aladin Pocket Frame Duo

Design Piero Lissoni

PORTA SCOMPARSA CON STIPITE / POCKET DOOR WITH VISIBLE FRAME

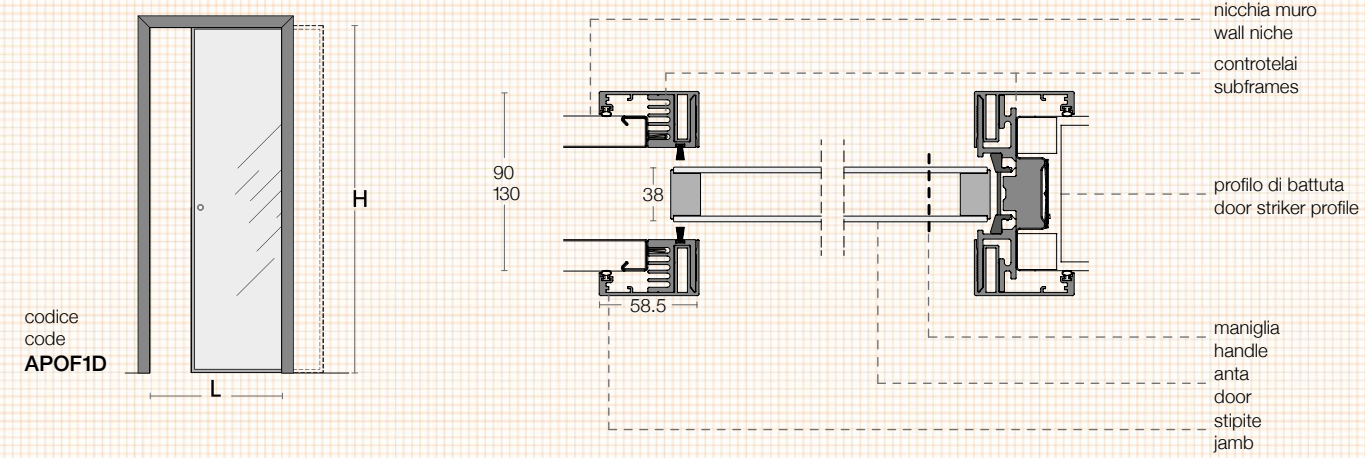

MANIGLIE PANNELLO DUO / HANDLES PANEL DUO

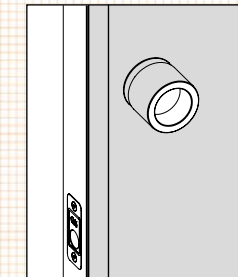

maniglia tonda
senza supporto /
round handle
without support

codice / code :
MSSP

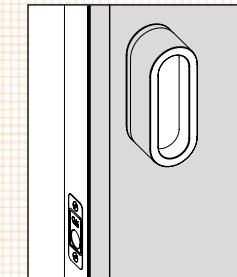

maniglia ovale senza supporto /
oval handle without support

codice / code :
MSOP

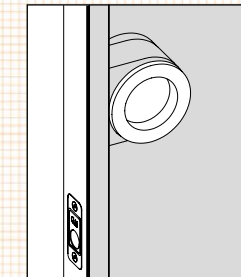

maniglia con supporto /
handle with support

codice / code :
MCSP

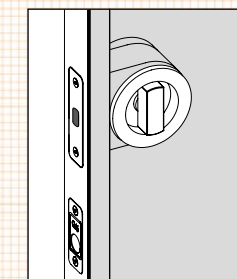

maniglia con nottolino /
handle with revolving plug

codice / code :
MCNP

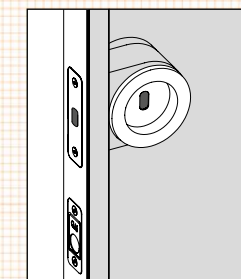

maniglia con chiave /
handle with key lock

codice / code :
MCCP

Aladin Double Pocket Frame Duo

Design Piero Lissoni

PORTA SCOMPARSA CON STIPITE / POCKET DOOR WITH VISIBLE FRAME

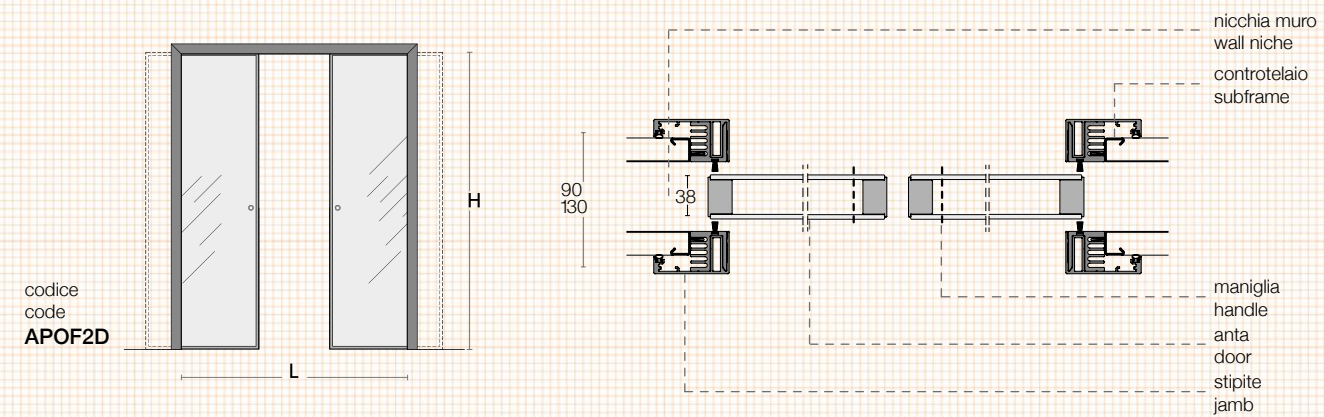

MANIGLIE PORTA A SCOMPARSA ANTA DOPPIA / HANDLES DOUBLE POCKET DOOR

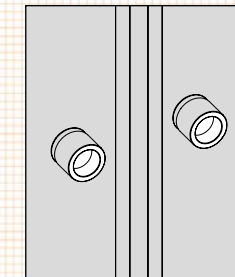

maniglia doppia tonda
senza supporto /
double round handle
without support

codice / code :
M2SSP

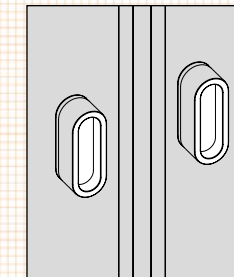

maniglia doppia ovale
senza supporto /
double oval handle
without support

codice / code :
M2SOP

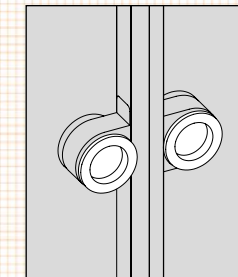

maniglia doppia
con supporto /
double handle
with support

codice / code :
M2CSP

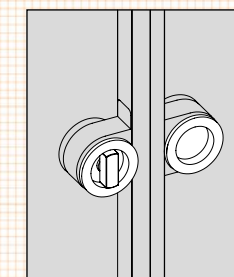

maniglia doppia
con nottolino /
double handle
with revolving plug

codice / code :
M2CNP

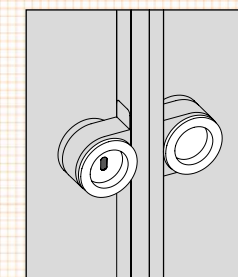

maniglia doppia
con chiave /
double handle
with key lock

codice / code :
M2CCP

IT

Sherazade Swing Plain è una porta singola o doppia a battente prodotta su misura, che si distingue per la grande pulizia formale e la cura dei dettagli, in cui il telaio dell'anta è a raso muro. Un vetro temperato monolitico da 6 mm o stratificato da 3 + 3 mm è inserito tramite una guarnizione nel telaio d'alluminio, fornito in cinque diverse finiture. I vetri, disponibili in una vastissima gamma di finiture, sono certificati secondo le normative di sicurezza ANSI Z97.1 e UNI ENI 2150 (ad eccezione di 533. armato). Sono disponibili anche pannelli in gres o in legno, con diverse finiture ed essenze. È possibile montare tre tipi di serratura (senza blocco, con cilindro, con nottolino) e scegliere tra maniglia o pomolo, che sono forniti nella stessa finitura del telaio. Le cerniere sono a perno regolabili. Il controtelaio in alluminio decapato, invisibile quando la porta è chiusa, è disponibile sia per pareti cementizie sia in cartongesso e può essere verniciato direttamente con la pittura delle pareti. L'anta singola è disponibile anche nella versione filo soffitto. L'intero gruppo maniglia è trattato con una speciale vernice igienizzante (testata secondo la norma ISO 22196:2011) che, contrastando la proliferazione batterica, garantisce la massima igiene e pulizia delle superfici.

EN

Sherazade Swing Plain is a single or double custom made swing door with a concealed frame, which stands out for its clean lines and attention to detail, whose door panel fits flush to the wall. The monolithic 6 mm or laminated 3 + 3 mm thick tempered glass is inserted by means of a seal in the aluminium frame, which is supplied in five different finishes. The glasses are available in a wide range of finishes and they are certified according to the safety regulations ANSI Z97.1 and UNI ENI 2150 (with the exception of 533. armato). Panels in stoneware and in wood with different finishes and essences are available too. It is possible to assemble three kinds of lock (without block, with cylinder, with revolving plug) and choose between handle or knob and they are supplied in the same finish of the frame. The hinges are with adjustable pivot. The pickled aluminium subframe, invisible when the door is closed, is available for both cement and plasterboard walls and it can be varnished during the painting of the walls. The single swing door is also available fitted flush to the ceiling. The entire handle set is treated with a special sanitizing varnish (tested according to ISO 22196: 2011) which, by counteracting bacterial overgrowth, guarantees maximum hygiene and cleanliness of the surfaces.

FR

Sherazade Swing Plain est une porte battante simple ou double produite sur mesure, qui ressort pour l'extrême essentialité et le soin des détails, dont le châssis de la porte est à fleur avec le mur. Un verre trempé monolithique de 6 mm ou stratifié de 3 + 3 mm est inséré par un joint dans le cadre d'aluminium, disponible en cinq finitions différentes. Les verres sont disponibles dans une large gamme de finitions, ils sont certifiés selon les normes de sécurité ANSI Z97.1 et UNI ENI 2150 (à l'exception de la finition 533. armato). Panneaux en grès et bois en différentes finitions et essences sont également disponibles. Il est possible d'équiper trois types de verrouillage (sans serrure, avec cylindre, avec verrou) et choisir parmi la poignée ou le pommeau qui sont fournis dans la même finition que le cadre. Les charnières sont réglables à la broche. Le pré-cadre en aluminium décapé, invisible lorsque la porte est fermée, est disponible soit pour les murs de ciment soit pour le placoplâtre et peut être verni directement pendant la peinture des murs. La porte battante simple est disponible aussi dans la version au ras du plafond. L'entière bloc poignée est traité avec un vernis désinfectant spécial (testé selon ISO 22196: 2011) qui, en neutralisant la prolifération bactérienne, garantit une hygiène et une propreté maximales des surfaces.



DE

Sherazade Swing Plain ist eine Einzel-oder Doppeldrehtür bündig mit der Wand, nach Maß herstellt und von außergewöhnlicher Reinheit der Formen und besonderer Qualität des Details gekennzeichnet. Das Glas kann 6 mm stark monolithisch gehärtet oder 3 + 3 mm stark beschichtet sein. Es ist mittels einer Dichtung in dem Aluminiumrahmen eingesetzt, der in fünf verschiedenen Ausführungen erhältlich ist. Die Gläser sind in einer sehr weiten Serie von Ausführungen verfügbar und sind gemäß ANSI Z97.1 and UNI ENI 2150 zertifiziert (außer für die Ausführung 533. armato). Gres-und Holzpaneele in verschiedenen Ausführungen und Hölzern sind ebenfalls erhältlich. Man kann drei verschiedene Arten von Schloss (ohne Blockierung, mit Zylinder, mit Klinkeschloss) montieren und zwischen Klinke oder Knopf, in der selben Ausführung des Rahmens wählen. Die Zapfenscharniere sind verstellbar. Der Doppelrahmen aus dekapiertem Aluminium, unsichtbar bei geschlossener Tür, ist sowohl für Betonwände als auch für Gipskartonwände verfügbar. Die Rahmeninstallation muss während der Rohbauphase durchgeführt werden, die Feinbearbeitung direkt beim Streichen der Wände. Die Einzeldrehtür ist auch in der deckenbündigen Version verfügbar. Die gesamte Griffbaugruppe wird mit einem speziellen, hygienischen Lack (geprüft nach ISO 22196: 2011) behandelt, der durch die Bekämpfung des Bakterienwachstums maximale Hygiene und Sauberkeit der Oberflächen garantiert.

ES

Sherazade Swing Plain es una puerta batiente simple o doble producida a medida, que se distingue por su gran limpieza formal y atención a los detalles, cuyo marco es a ras de la pared. El cristal templado monolitico de 6 mm o estratificado 3 + 3 mm, está insertado por medio de una junta en el marco de aluminio, suministrado en cinco diferentes acabados. Los cristales, disponibles en una amplia gama de acabados, son certificados según las normativas de seguridad ANSI Z97.1 y UNI EN12150 (a excepción de 533. armato). Están disponibles también paneles de gres y madera con diferentes acabados y esencias. Es posible montar tres tipos de cerradura (sin bloque, con cilindro, con pasador de balancín) y elegir entre manilla o pomolo, en el mismo acabado del marco. Las bisagras son de perno regulables. El contra marco en aluminio decapado, invisible cuando la puerta esta cerrada, está disponible tanto para paredes de cemento como de pladur y puede ser barnizado directamente con la pintura de las paredes. La puerta batiente simple es disponible también en la versión hilo techo. La manilla completa está tratada con un especial barniz desinfectante (probado según la norma ISO 22196:2011) que, contrastando la proliferación bacteriana, garantiza la maxima higiene y limpieza de las superficies.

Sherazade Swing Plain

Design Piero Lissoni

PORTA BATTENTE RASOMURO / SWING DOOR WITH CONCEALED FRAME

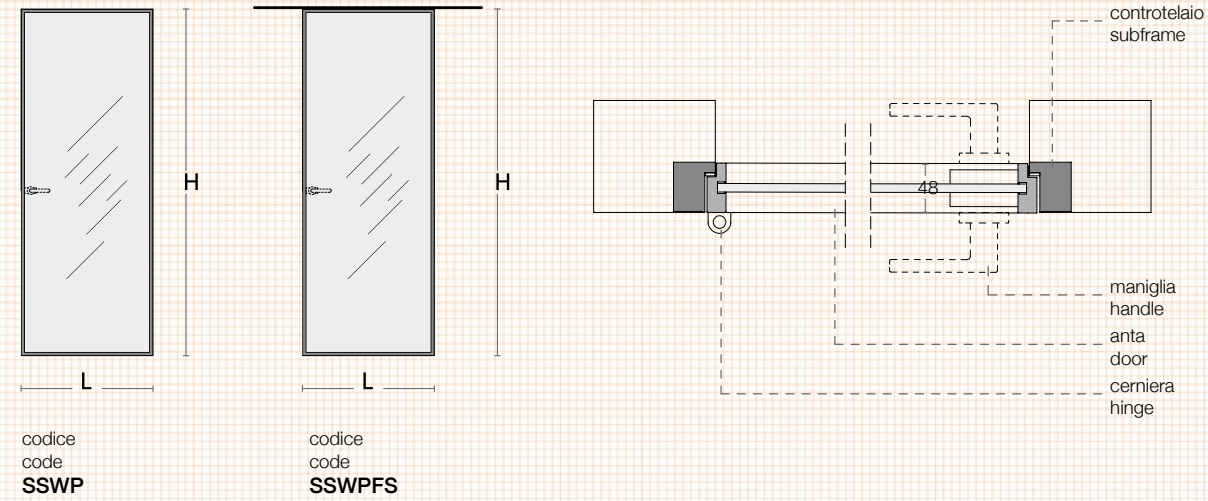

IPOTESI PROGETTUALI / PROJECT CONFIGURATIONS

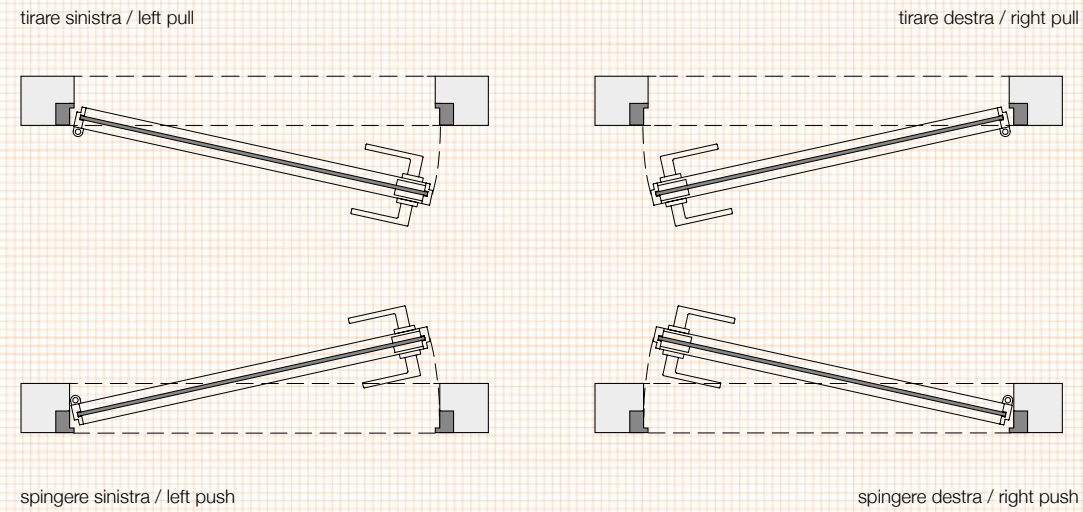

MANIGLIE SHERAZADE SWING PLAIN / HANDLES SHERAZADE SWING PLAIN

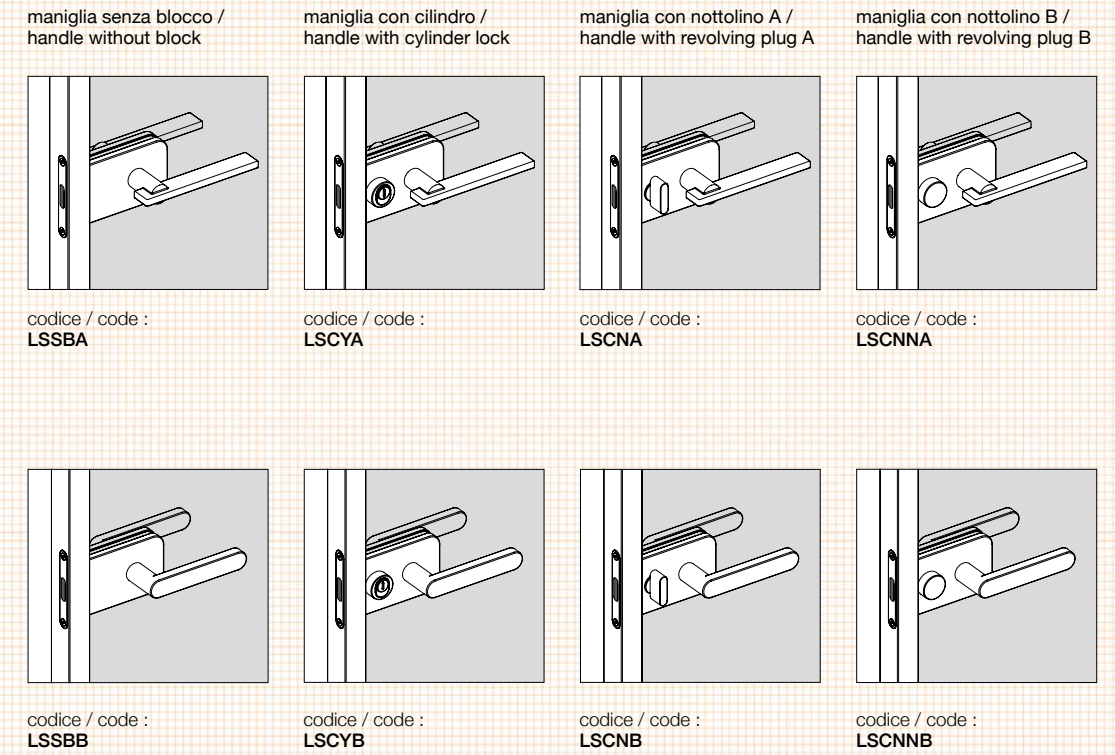

POMOLI SHERAZADE SWING PLAIN / KNOBS SHERAZADE SWING PLAIN

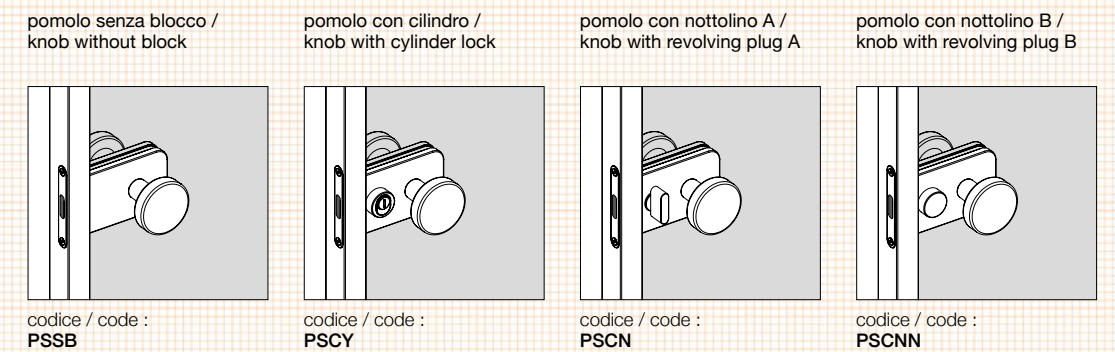

Sherazade Double Swing Plain

Design Piero Lissoni

PORTA DOPPIA BATTENTE RASOMURO / DOUBLE SWING DOOR WITH CONCEALED FRAME

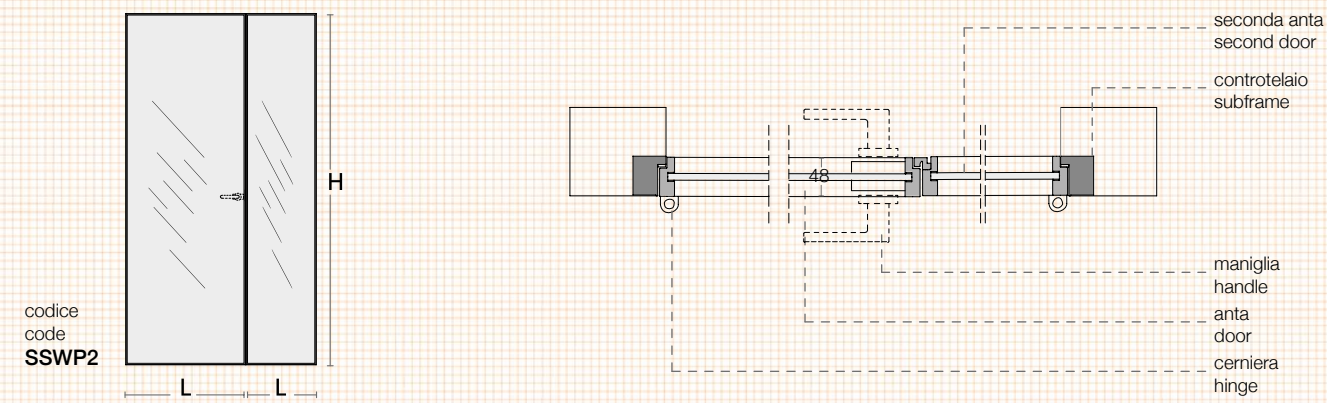

IPOTESI PROGETTUALI / PROJECT CONFIGURATIONS

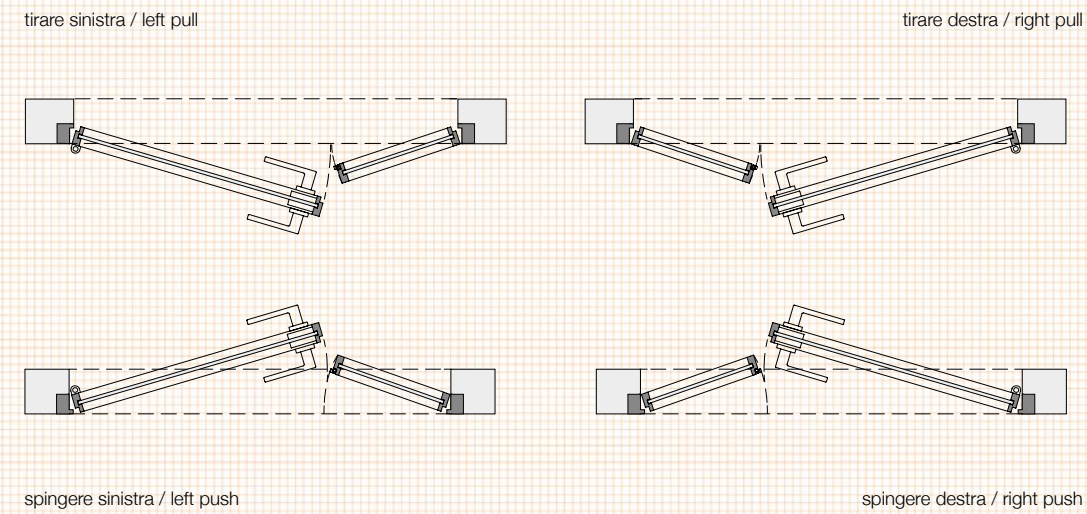

MANIGLIE SHERAZADE DOUBLE SWING PLAIN / HANDLES SHERAZADE DOUBLE SWING PLAIN

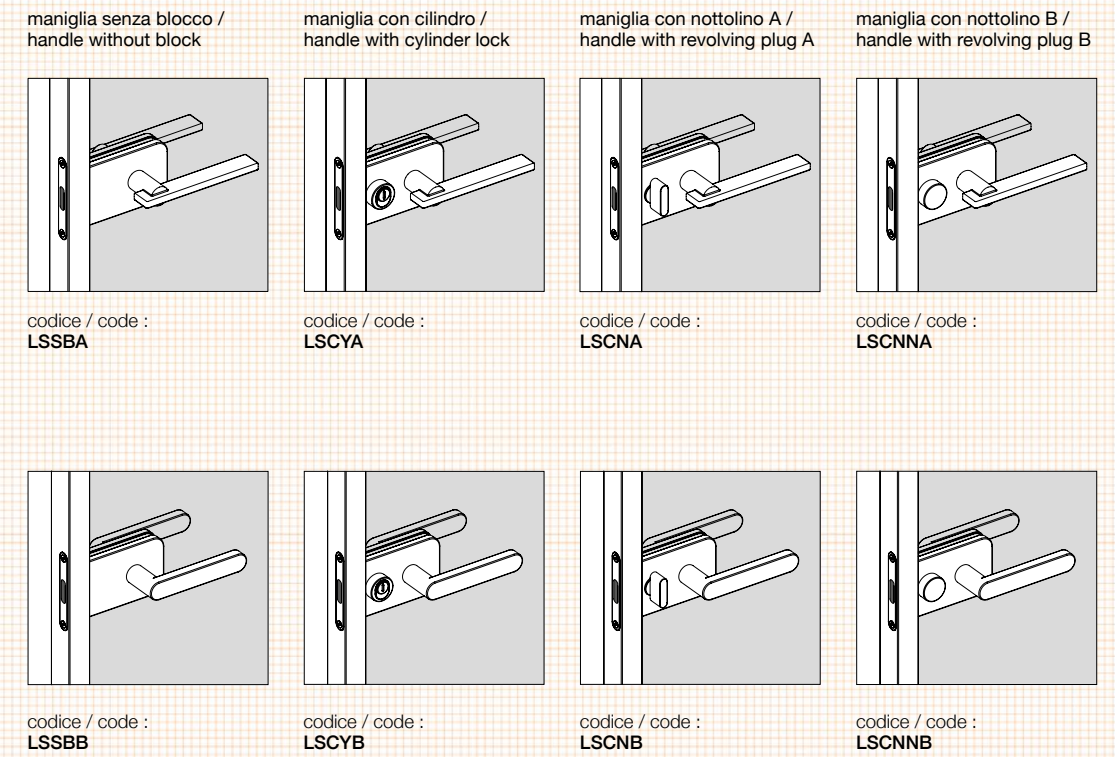

POMOLI SHERAZADE DOUBLE SWING PLAIN / KNOBS SHERAZADE DOUBLE SWING PLAIN

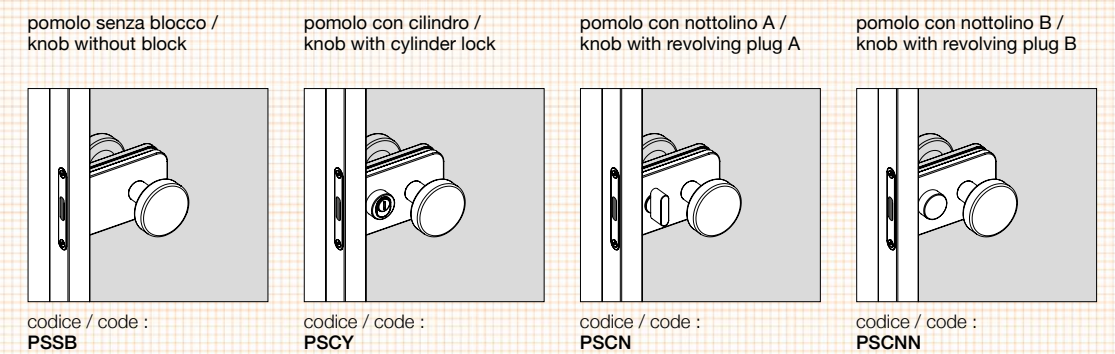

IT

Sherazade Swing Plain Patchwork è una porta singola o doppia a battente prodotta su misura, che si distingue per la grande pulizia formale, in cui il telaio dell'anta è a raso muro. Una porta dalla grande eleganza e cura dei dettagli, la cui superficie è ripartita in quattro riquadri, in cui possono essere posizionati diversi tipi di cristalli temperati monolitici 6 mm o stratificati 3 + 3 mm. Questi pannelli, tramite una guarnizione, vengono inseriti al centro di profili d'alluminio, forniti in cinque diverse finiture. I vetri, disponibili in una vastissima gamma di finiture, sono certificate secondo le normative di sicurezza ANSI Z97.1 e UNI ENI 2150 (ad eccezione di 533. retinato). Sono disponibili anche pannelli in gres o in legno, con diverse finiture ed essenze. È possibile montare tre tipi di serratura (senza blocco, con cilindro, con nottolino) e scegliere tra maniglia o pomolo, che sono forniti nella stessa finitura del telaio.

Le cerniere sono a perno regolabili. Il controtelaio in alluminio decapato, invisibile quando la porta è chiusa, è disponibile sia per pareti cementizie sia in cartongesso e può essere verniciato direttamente con la pittura delle pareti. L'anta singola è disponibile anche nella versione filo soffitto. L'intero gruppo maniglia è trattato con una speciale vernice igienizzante (testata secondo la norma ISO 22196:2011) che, contrastando la proliferazione batterica, garantisce la massima igiene e pulizia delle superfici.

EN

Sherazade Swing Plain Patchwork is a single or double custom made swing door with a concealed frame, which stands out for its clean lines, whose door panel fits flush to the wall. Is a door panel of great detail and elegance whose surface is divided into four parts where different types of glass, tempered monolithic 6 mm or laminated 3 + 3 mm, can be used. These panels, fitted using a gasket, are inserted in the centre of the aluminum profiles, supplied in five different finishes. The glass, available in a very wide range of finishes, is certified in compliance with the ANSI Z97.1 and UNI ENI 2150 safety regulations (except the finish 533. retinato). Panels in stoneware and in wood with different finishes and essences are available too. It is possible to assemble three kinds of lock (without block, with cylinder, with revolving plug) and choose between handle or knob and they are supplied in the same finish of the frame. The hinges are with adjustable pivot. The pickled aluminium subframe, invisible when the door is closed, is available for both cement and plasterboard walls and it can be varnished during the painting of the walls. The single swing door is also available fitted flush to the ceiling. The entire handle set is treated with a special sanitizing varnish (tested according to ISO 22196: 2011) which, by counteracting bacterial overgrowth, guarantees maximum hygiene and cleanliness of the surfaces.

FR

Sherazade Swing Plain Patchwork est une porte battante simple ou double produite sur mesure, qui ressort pour l'extrême essentialité, dont le châssis de la porte est à fleur avec le mur. Est une porte de grande élégance et soin des détails, dont la surface est divisée en quatre panneaux, dans lesquels différents types de verre trempé monolithique 6 mm ou stratifié 3 + 3 mm peuvent être positionnés. Ces panneaux, à travers un joint, sont insérés au centre des profils en aluminium, fournis en cinq finitions différentes. Les verres, disponibles dans une vaste gamme de finitions, sont certifiés selon les normes de sécurité ANSI Z97.1 et UNI EN12150 (exclue la finition 533. retinato). Panneaux en grès et bois en différentes finitions et essences sont également disponibles. Il est possible d'équiper trois types de verrouillage (sans serrure, avec cylindre, avec verrou) et choisir parmi la poignée ou le pommeau qui sont fournis dans la même finition que le cadre. Les charnières sont réglables à la broche. Le pré-cadre en aluminium décapé, invisible lorsque la porte est fermée, est disponible soit pour les murs de ciment soit pour le placoplâtre et peut être verni directement pendant la peinture des murs. La porte battante simple est disponible aussi dans la version au ras du plafond. L'entière bloc poignée est traité avec un vernis désinfectant spécial (testé selon ISO 22196 2011) qui, en neutralisant la prolifération bactérienne, garantit une hygiène et une propreté maximales des surfaces.



DE

Sherazade Swing Plain Patchwork ist eine Einzel-oder Doppeldrehtür bündig mit der Wand, nach Maß herstellt und von außergewöhnlicher Reinheit der Formen und besonderer Qualität der Details gekennzeichnet.

Ist eine Tür gekennzeichnet durch außergewöhnliche Eleganz und besondere Qualität der Details. Die Oberfläche ist auf vier Felder aufgeteilt, wo verschiedene Glastypologien von 6 mm starken monolithischen gehärteten Gläsern oder 3 + 3 mm. Starken beschichteten Gläsern platziert werden können. Diese Glaspaneele sind mittels einer Dichtung in dem Aluminiumrahmen eingesetzt, der in fünf verschiedenen Ausführungen erhältlich ist. Die Gläser sind in einer sehr weiten Serie von Ausführungen verfügbar und sind gemäß ANSI Z97.1 und UNI ENI 2150 zertifiziert (ausschließlich 533. retinato). Gres-und Holzpaneele in verschiedenen Ausführungen und Hölzern sind ebenfalls erhältlich. Man kann drei verschiedene Arten von Schloss (ohne Blockierung, mit Zylinder, mit Klinkeschloss) montieren und zwischen Klinke oder Knopf, in derselben Ausführung des Rahmens wählen. Die Zapfenscharniere sind verstellbar. Der Doppelrahmen aus dekapiertem Aluminium, unsichtbar bei geschlossener Tür, ist sowohl für Betonwände als auch für Gipskartonwände verfügbar. Die Rahmeninstallation muss während der Rohbauphase durchgeführt werden, die Feinbearbeitung direkt beim Streichen der Wände. Die Einzeldrehtür ist auch in der deckenbündigen Version verfügbar. Die gesamte Griffbaugruppe wird mit einem speziellen, hygienischen Lack (geprüft nach ISO 22196: 2011) behandelt, der durch die Bekämpfung des Bakterienwachstums maximale Hygiene und Sauberkeit der Oberflächen garantiert.

ES

Sherazade Swing Plain Patchwork es una puerta batiente simple o doble producida a medida, que se distingue por su gran limpieza formal, cuyo marco es a ras de la pared. Es una puerta caracterizada por la gran elegancia y atención a los detalles, cuya superficie está dividida en cuatro cuadrados, donde se pueden posicionar diferentes tipos de cristales templados monolíticos de 6 mm o estratificado 3 + 3 mm. Estos paneles, por medio de una junta, están insertados en el centro del marco de aluminio, suministrado en cuatro acabados diferentes. Los cristales, disponibles en una amplia gama de acabados, son certificados según las normativas de seguridad ANSI Z97.1 y UNI ENI 2150 (533. Retinato excluido). Estàn disponibles también paneles de gres y madera con diferentes acabados y esencias. Es posible montar tres tipos de cerradura (sin bloque, con cilindro, con pasador de balancín) y elegir entre manilla o pomo, en el mismo acabado del marco. Las bisagras son de perno regulables.

El contra marco en aluminio decapado, invisible cuando la puerta esta cerrada, está disponible tanto para paredes de cemento como de pladur y puede ser barnizado directamente con la pintura de las paredes. La puerta batiente simple es disponible también en la versión hilo techo. La manilla completa está tratada con un especial barniz desinfectante (probado según la norma ISO 22196:2011) que, contrastando la proliferación bacteriana, garantiza la máxima higiene y limpieza de las superficies.

Sherazade Swing Plain Patchwork

Design Piero Lissoni

CONFIGURAZIONE / CONFIGURATION

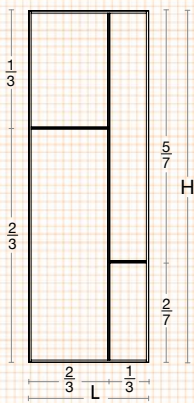
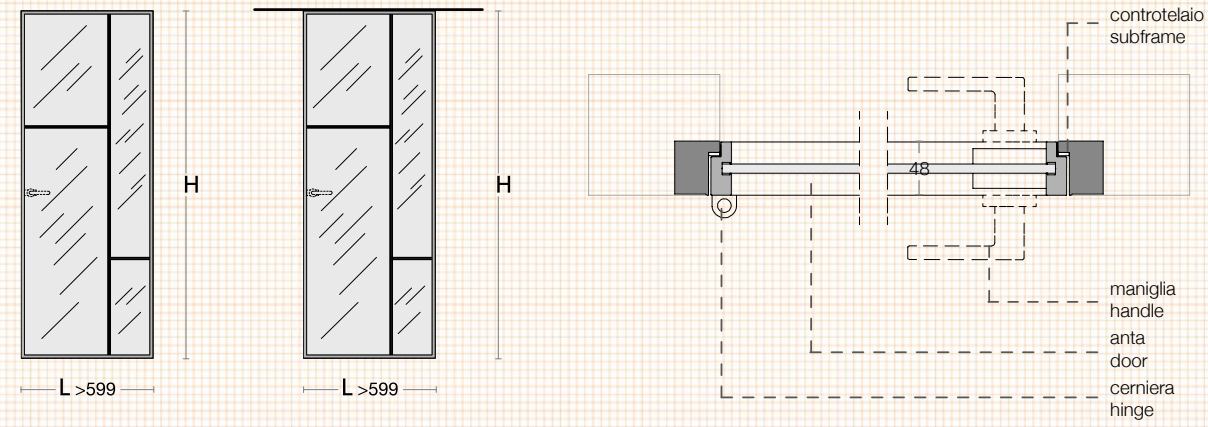

codice / code :
SSWPP01

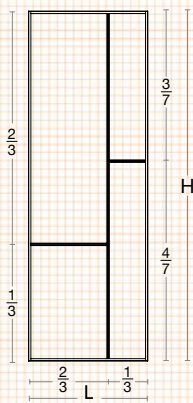

codice / code :
SSWPP02

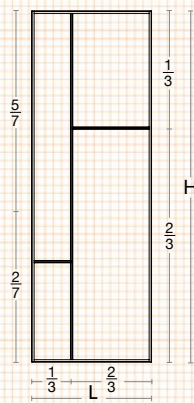

codice / code :
SSWPP03

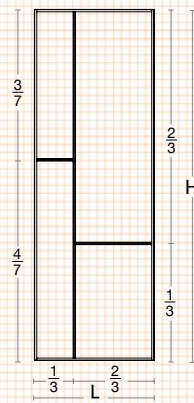

codice / code :
SSWPP04

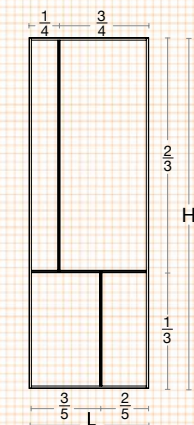

codice / code :
SSWPP05

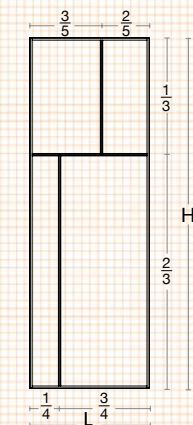

codice / code :
SSWPP06

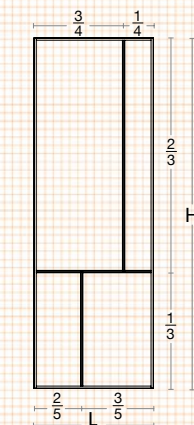

codice / code :
SSWPP07

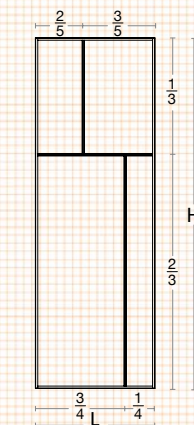

codice / code :
SSWPP08

IPOTESI PROGETTUALI / PROJECT CONFIGURATIONS

tirare sinistra / left pull

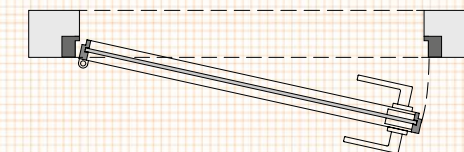

tirare destra / right pull

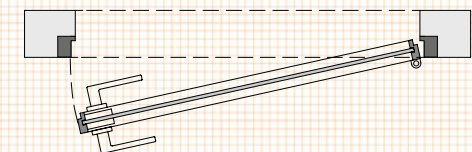

spingere sinistra / left push

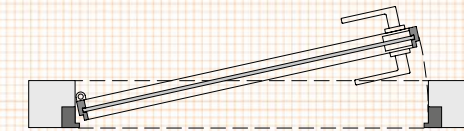

spingere destra / right push

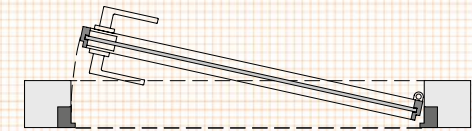

Sherazade Swing Plain Patchwork

Design Piero Lissoni

MANIGLIE SHERAZADE SWING PLAIN PATCHWORK / HANDLES SHERAZADE SWING PLAIN PATCHWORK

maniglia senza blocco /
handle without block

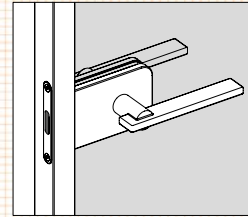

codice / code :
LSSBA

maniglia con cilindro /
handle with cylinder lock

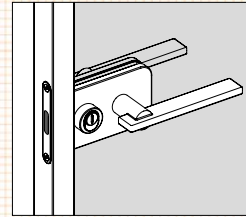

codice / code :
LSCYA

maniglia con nottolino A /
handle with revolving plug A

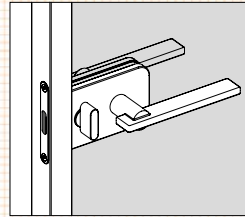

codice / code :
LSCNA

maniglia con nottolino B /
handle with revolving plug B

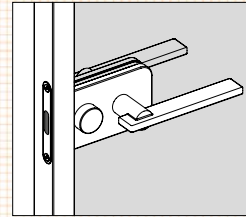

codice / code :
LSCNNA

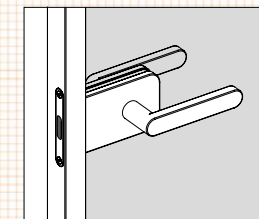

codice / code :
LSSBB

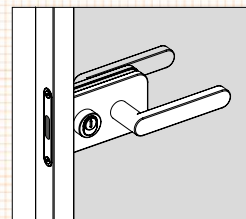

codice / code :
LSCYB

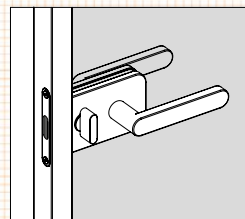

codice / code :
LSCNB

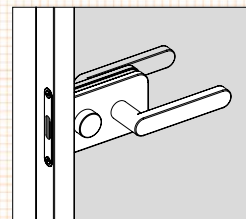

codice / code :
LSCNNB

POMOLI SHERAZADE SWING PLAIN PATCHWORK / KNOBS SHERAZADE SWING PLAIN PATCHWORK

pomolo senza blocco /
knob without block

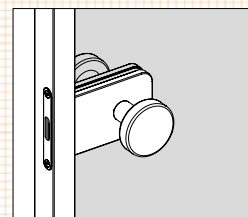

codice / code :
PSSB

pomolo con cilindro /
knob with cylinder lock

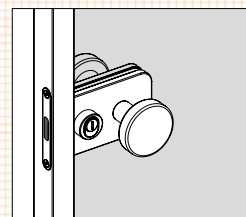

codice / code :
PSCY

pomolo con nottolino A /
knob with revolving plug A

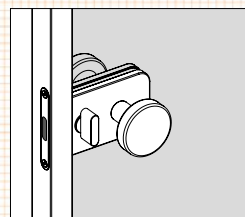

codice / code :
PSCN

pomolo con nottolino B /
knob with revolving plug B

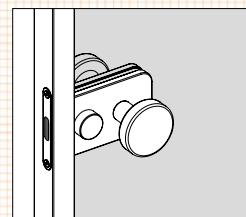

codice / code :
PSCNN

Sherazade Double Swing Plain Patchwork

Design Piero Lissoni

PORTA BATTENTE RASOMURO / SWING DOOR WITH CONCEALED FRAME

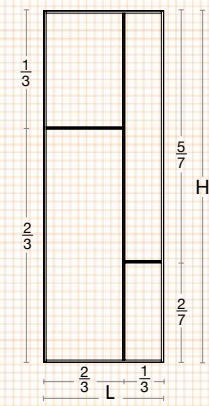
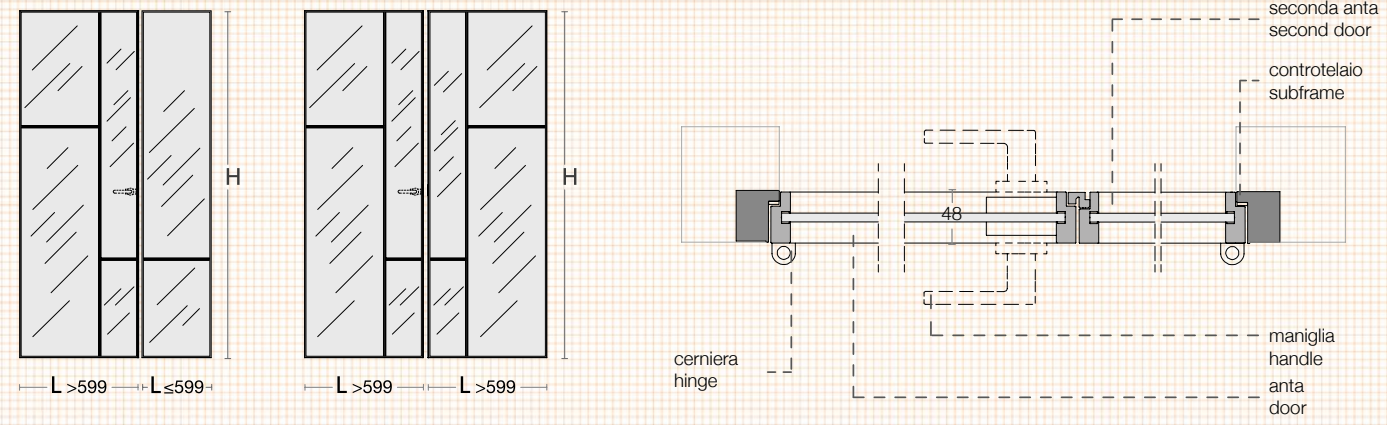

codice / code :
SSWPP01D

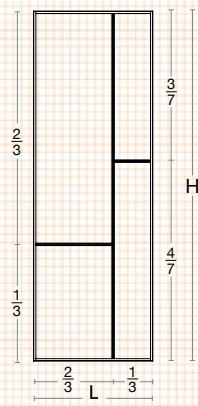

codice / code :
SSWPP02D

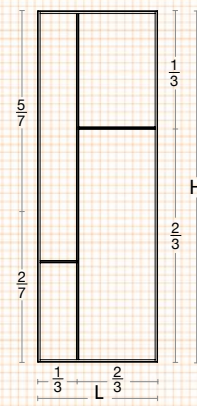

codice / code :
SSWPP03D

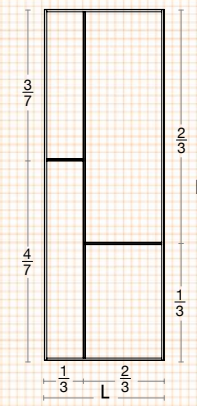

codice / code :
SSWPP04D

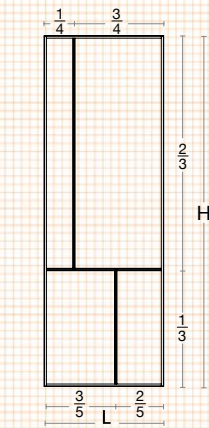

codice / code :
SSWPP05D

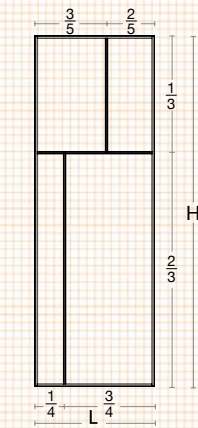

codice / code :
SSWPP06D

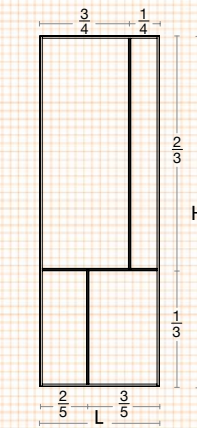

codice / code :
SSWPP07D

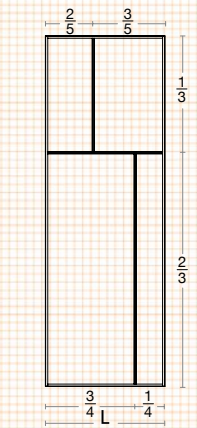

codice / code :
SSWPP08D

CONFIGURAZIONE PORTA / CONFIGURATION DOOR

opzioni seconda
anta L ≤ 599 mm /
second door panel
option L ≤ 599 mm



codice / code :
SSWPP09D

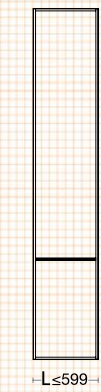

codice / code :
SSWPP10D

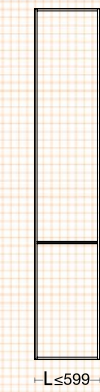

codice / code :
SSWPP11D

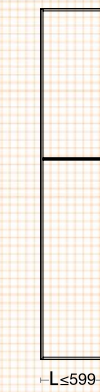

codice / code :
SSWPP12D

IPOTESI PROGETTUALI / PROJECT CONFIGURATIONS

tirare sinistra / left pull

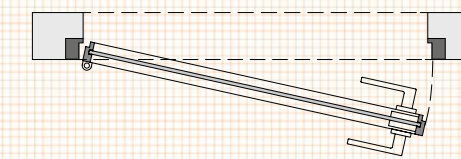

tirare destra / right pull

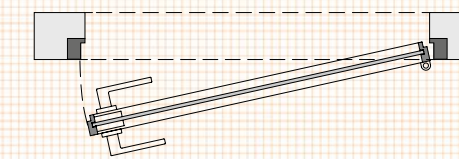

spingere sinistra / left push

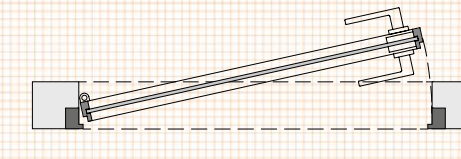

spingere destra / right push

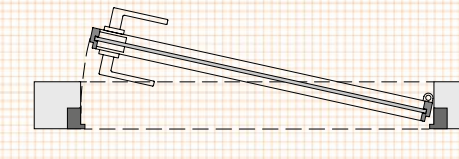

Sherazade Double Swing Plain Patchwork

Design Piero Lissoni

MANIGLIE SHERAZADE DOUBLE WING PLAIN PATCHWORK / HANDLES SHERAZADE DOUBLE SWING PLAIN PATCHWORK

maniglia senza blocco /
handle without block

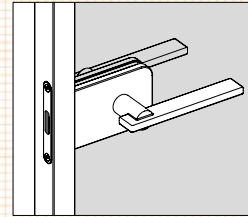

codice / code :
LSSBA

maniglia con cilindro /
handle with cylinder lock

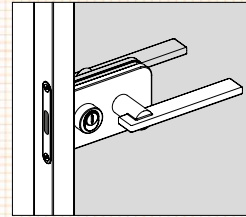

codice / code :
LSCYA

maniglia con nottolino A /
handle with revolving plug A

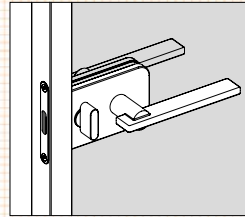

codice / code :
LSCNA

maniglia con nottolino B /
handle with revolving plug B

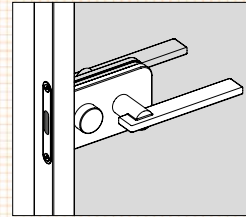

codice / code :
LSCNNA

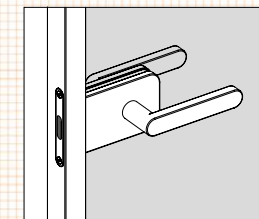

codice / code :
LSSBB

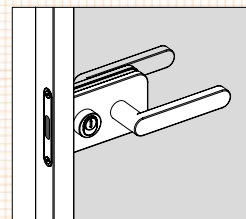

codice / code :
LSCYB

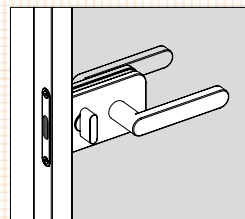

codice / code :
LSCNB

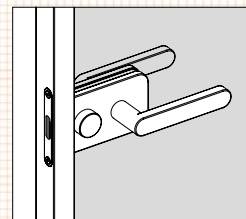

codice / code :
LSCNNB

POMOLI SHERAZADE SWING PLAIN PATCHWORK / KNOBS SHERAZADE SWING PLAIN PATCHWORK

pomolo senza blocco /
knob without block

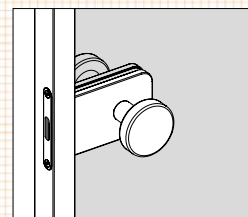

codice / code :
PSSB

pomolo con cilindro /
knob with cylinder lock

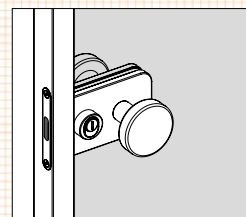

codice / code :
PSCY

pomolo con nottolino A /
knob with revolving plug A

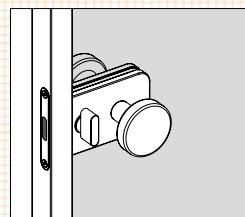

codice / code :
PSCN

pomolo con nottolino B /
knob with revolving plug B

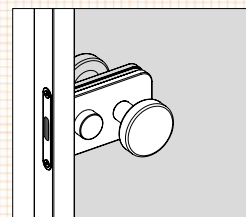

codice / code :
PSCNN

IT

Sherazade Swing Slim Jambs è una porta singola o doppia a battente prodotta su misura, che si distingue per la grande pulizia formale e la cura dei dettagli, con mini-profilo di battuta telescopici e cerniere a perno regolabili. Un vetro temperato monolitico da 6 mm o stratificato da 3 + 3 mm è inserito tramite guarnizione in un telaio d'alluminio, fornito in cinque diverse finiture. I vetri, disponibili in una vastissima gamma di finiture, sono certificati secondo le normative di sicurezza ANSI Z97.1 e UNI ENI 2150 (ad eccezione di 533. armato). Sono disponibili anche pannelli in gres o in legno, con diverse finiture ed essenze. È possibile montare tre tipi di serratura (senza blocco, con cilindro, con nottolino) e scegliere tra maniglia o pomolo che, come i profili di battuta, sono forniti nella stessa finitura del telaio. La porta singola è disponibile anche nella versione filo soffitto. L'intero gruppo maniglia è trattato con una speciale vernice igienizzante (testata secondo la norma ISO 22196:2011) che, contrastando la proliferazione batterica, garantisce la massima igiene e pulizia delle superfici.

EN

Sherazade Swing Slim Jambs is a custom-made single or double swing door, exemplified by its great formal cleanliness and attention to detail, with mini telescopic stop profiles and adjustable hinges. A 6mm monolithic tempered glass or 3+3mm laminated glass is fitted by means of a gasket in an aluminum frame, supplied in five different finishes. The glass is available in a very wide range of finishes and is certified according to the ANSI Z97.1 and UNI EN12150 safety standards (except for 533. retinato). There are stoneware and wood veneer doors in different finishes as well. It is possible to mount three types of closure (without lock, with cylinder twist lock, with pawl) and a choice of handles or knobs which, like the stop profiles, are supplied in the same color as the frame. The single door is also available in a flush-to-ceiling version. The entire handle unit is treated with a special sanitizing coating (tested according to ISO 22196: 2011 standard) which, by countering the bacterial proliferation, guarantees maximum hygiene and surface cleanliness.

FR

Sherazade Swing Slim Jambs est une porte battante simple ou double sur mesure, qui ressort pour l'extrême essentialité et le soin des détails, avec des mini-profilés télescopiques de butée et des charnières pivotantes réglables. Un verre trempé monolithique de 6 mm ou un verre feuilleté de 3 + 3 mm est inséré à travers une garniture dans un cadre en aluminium, fourni en cinq finitions différentes. Les verres, sont disponibles dans une vaste gamme de finitions, sont certifiés selon les normes de sécurité ANSI Z97.1 et UNI ENI 2150 (à l'exception du 533. retinato). Panneaux en grès ou en bois en différentes finitions et essences sont également disponibles. Il est possible d'équiper trois types de verrouillage (sans serrure, à cylindre, avec loqueteau) et de choisir entre poignée ou pommeau qui, comme les profils de butée, sont fournis dans la même finition que le cadre. La porte simple est également disponible dans la version au ras du plafond. L'ensemble de la poignée est traité avec une peinture assainissante spéciale (testée selon la norme ISO 22196 : 2011) qui, en luttant contre la prolifération bactérienne, garantit une hygiène et une propreté de surfaces maximales.



DE

Sherazade Swing Slim Jambs ist eine nach Maß angefertigte Einzel- oder Doppeldrehtür, die sich durch große formale Sauberkeit und Sorgfalt zum Detail auszeichnet, mit teleskopischen Mini-Anschlagprofilen (Mini-Pfosten) und verstellbaren Zapfenscharnieren. Ein 6 mm starkes monolithisches gehärtetes Glas oder ein 3 + 3 mm beschichtetes Glas wird mittels einer Dichtung in einen Aluminiumrahmen eingesetzt, der in fünf verschiedenen Ausführungen geliefert wird. Die Gläser, die in einer sehr breiten Palette von Ausführungen erhältlich sind, sind gemäß ANSI Z97.1 und UNI ENI 2150 Sicherheitsvorschriften zertifiziert (mit Ausnahme von 533. retinato). Feinsteinzeug- und Holzpaneele in verschiedenen Ausführungen und Varianten sind ebenfalls erhältlich. Es ist möglich, drei Schlosstypen (ohne Blockierung, mit Zylinder, mit Sperrklinke) einzusetzen oder zwischen Türgriff oder Knauf zu wählen, die wie die Anschlagprofile in der gleichen Ausführung wie der Rahmen geliefert werden. Die Einzeldrehtür ist auch in der deckenbündigen Version erhältlich. Die gesamte Griffeinheit ist mit einem speziellen Desinfektionslack (getestet nach ISO 22196:2011 Vorschrift) behandelt, der durch die Bekämpfung der Bakterienvermehrung die höchste Hygiene und Oberflächenreinheit garantiert.

ES

Sherazade Swing Slim Jambs es una puerta abatible simple o doble hecha a medida, que destaca por su gran limpieza formal y atención al detalle, con mini-perfiles telescópicos y bisagras pivotantes regulables. Se inserta un vidrio templado monolítico de 6 mm o un vidriolaminado de 3 + 3 mm mediante una junta en un marco de aluminio, suministrado en cinco acabados diferentes. Los cristales, disponibles en una amplia gama de acabados, están certificados según las normas de seguridad ANSI Z97.1 y UNI ENI 2150 (a excepción del 533. retinato). También están disponibles los paneles en gres o madera, con diferentes acabados y materiales. Es posible montar tres tipos de cerraduras (sin cerradura, con cilindro, con trinquete) y elegir entre tirador o pomo que, al igual que los perfiles de tope, se suministran en el mismo acabado que el marco. La puerta simple también está disponible en la versión empotrada al techo. Toda la unidad de empuñadura está tratada con una pintura higienizante especial (testada según ISO 22196: 2011) que, al contrarrestar la proliferación bacteriana, garantiza la máxima higiene y limpieza de la superficie.

Sherazade Swing Slim Jambs

Design Piero Lissoni

PORTA BATTENTE RASOMURO / SWING DOOR WITH CONCEALED FRAME

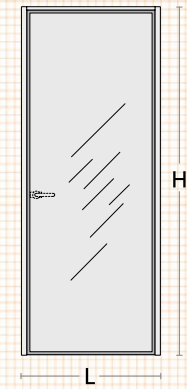

codice / code :
SSJM

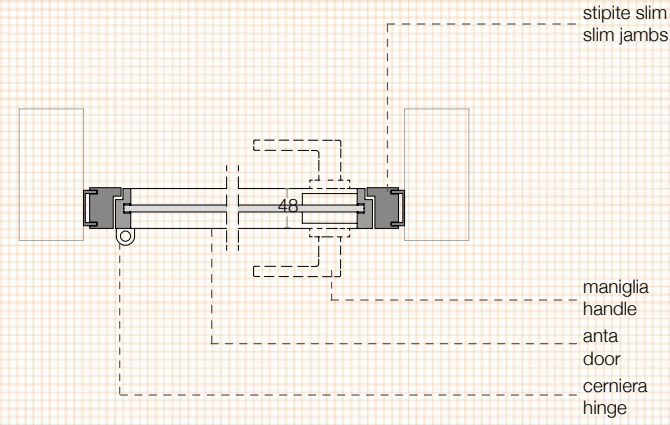

stipite slim
slim jambs

maniglia
handle
anta
door
cerniera
hinge

IPOTESI PROGETTUALI / PROJECT CONFIGURATIONS

tirare sinistra / left pull

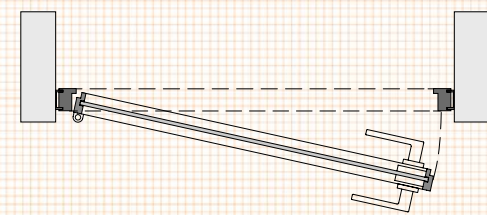

tirare destra / right pull

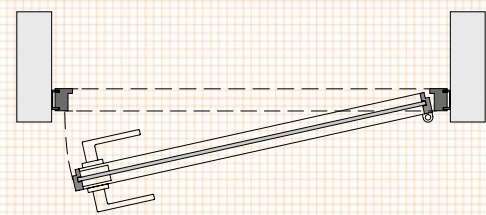

spingere sinistra / left push

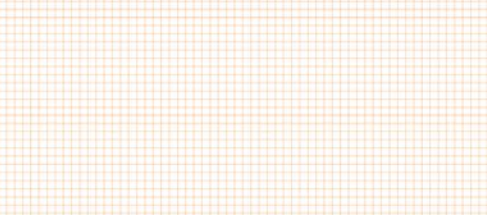

spingere destra / right push



MANIGLIE SHERAZADE SWING SLIM JAMBS / HANDLES SHERAZADE SWING SLIM JAMBS

maniglia senza blocco /
handle without block

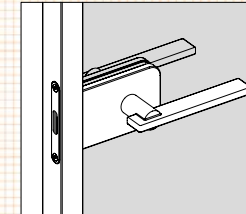

codice / code :
LSSBA

maniglia con cilindro /
handle with cylinder lock

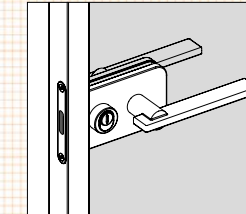

codice / code :
LSCYA

maniglia con nottolino A /
handle with revolving plug A

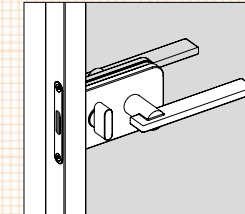

codice / code :
LSCNA

maniglia con nottolino B /
handle with revolving plug B

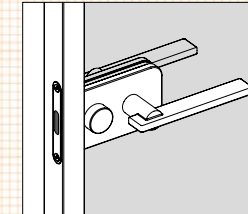

codice / code :
LSCNNA

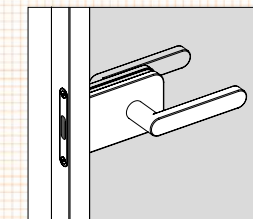

codice / code :
LSSBB

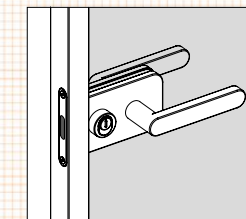

codice / code :
LSCYB

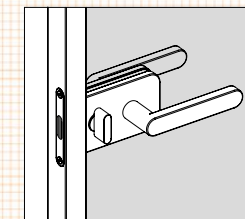

codice / code :
LSCNB

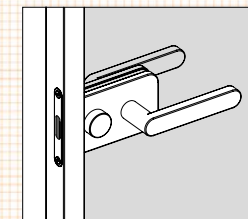

codice / code :
LSCNNB

POMOLI SHERAZADE SWING SLIM JAMBS / KNOBS SHERAZADE SWING SLIM JAMBS

pomolo senza blocco /
knob without block

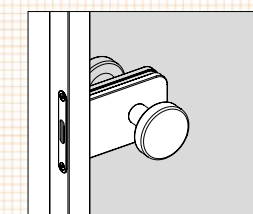

codice / code :
PSSB

pomolo con cilindro /
knob with cylinder lock

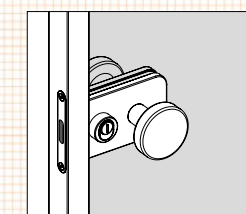

codice / code :
PSCY

pomolo con nottolino A /
knob with revolving plug A

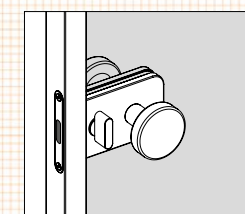

codice / code :
PSCN

pomolo con nottolino B /
knob with revolving plug B

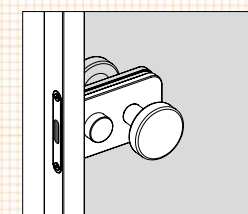

codice / code :
PSCNN

Sherazade Double Swing Slim Jambs

Design Piero Lissoni

PORTA BATTENTE RASOMURO / SWING DOOR WITH CONCEALED FRAME

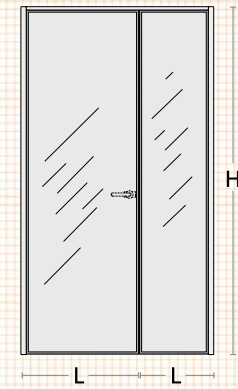

codice
code
SSJM2

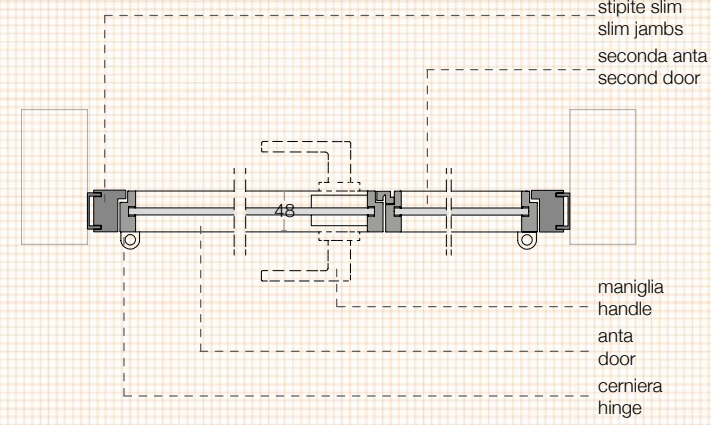

IPOTESI PROGETTUALI / PROJECT CONFIGURATIONS

tirare sinistra / left pull

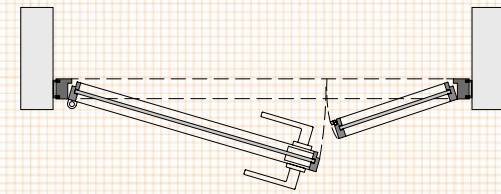

tirare destra / right pull

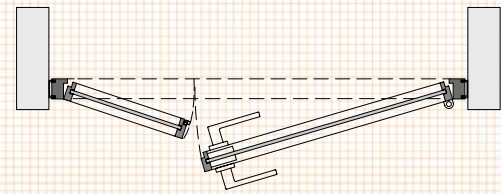

spingere sinistra / left push

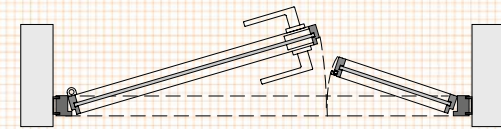

spingere destra / right push

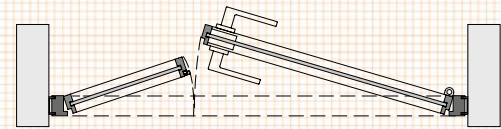

MANIGLIE SHERAZADE DOUBLE SWING SLIM JAMB / HANDLES SHERAZADE DOUBLE SWING SLIM JAMB

maniglia senza blocco /
handle without block

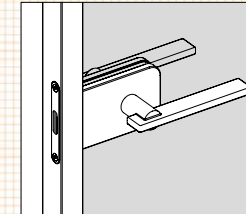

codice / code :
LSSBA

maniglia con cilindro /
handle with cylinder lock

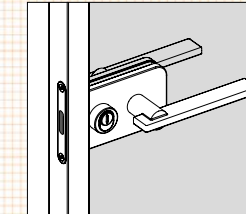

codice / code :
LSCYA

maniglia con nottolino A /
handle with revolving plug A

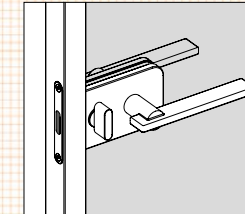

codice / code :
LSCNA

maniglia con nottolino B /
handle with revolving plug B

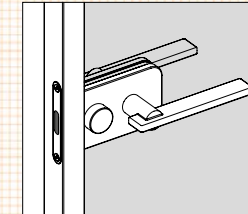

codice / code :
LSCNNA

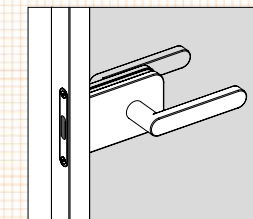

codice / code :
LSSBB

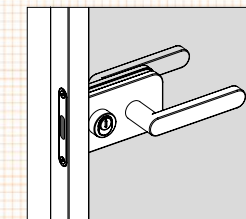

codice / code :
LSCYB

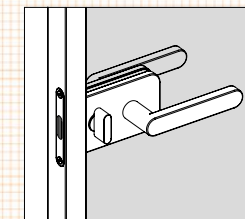

codice / code :
LSCNB

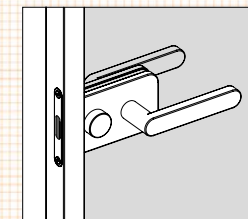

codice / code :
LSCNNB

POMOLI SHERAZADE DOUBLE SWING SLIM JAMB / KNOBS SHERAZADE DOUBLE SWING SLIM JAMB

pomolo senza blocco /
knob without block

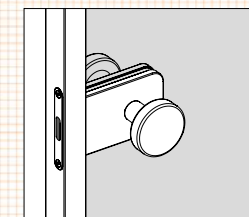

codice / code :
PSSB

pomolo con cilindro /
knob with cylinder lock

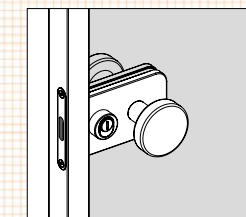

codice / code :
PSCY

pomolo con nottolino A /
knob with revolving plug A

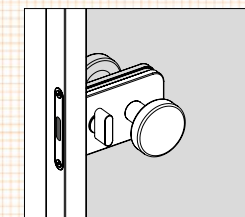

codice / code :
PSCN

pomolo con nottolino B /
knob with revolving plug B

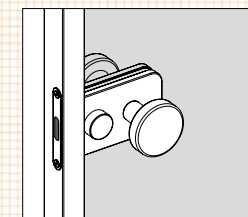

codice / code :
PSCNN

IT

Sherazade Swing Slim Jambs Patchwork una porta singola o doppia a battente prodotta su misura, che si distingue per la grande pulizia formale, con mini-profilo di battuta telescopici e cerniere a perno regolabili. Una porta dalla grande eleganza e cura dei dettagli, la cui superficie è ripartita in quattro riquadri, in cui possono essere posizionati diversi tipi di cristalli temperati monolitici mm. 6 o stratificati mm. 3+3. Questi pannelli, tramite una guarnizione, vengono inseriti al centro di profili d'alluminio, forniti in cinque diverse finiture. I vetri, disponibili in una vastissima gamma di finiture, sono certificati secondo le normative di sicurezza ANSI Z97.1 e UNI ENI 2150 (ad eccezione di 533. retinato). Sono disponibili anche pannelli in gres o in legno, con diverse finiture ed essenze. È possibile montare tre tipi di serratura (senza blocco, con cilindro, con nottolino) e scegliere tra maniglia o pomolo che, come i profili di battuta, sono forniti nella stessa finitura del telaio. La porta singola è disponibile anche nella versione filo soffitto. L'intero gruppo maniglia è trattato con una speciale vernice igienizzante (testata secondo la norma ISO 22196:2011) che, contrastando la proliferazione batterica, garantisce la massima igiene e pulizia delle superfici.

EN

Sherazade Swing Slim Jambs Patchwork is a custom-made single or double swing door, exemplified by its great formal cleanliness, with slim telescopic profiles and adjustable hinges. A door of great elegance and attention to detail, whose surface is divided into four panes, featuring featuring different types of monolithic tempered glass 6 mm or laminated 3 + 3 mm. These panels are fitted by means of a gasket in the center of aluminum profiles, available in five finishes and supported by a gasket. The glass is available in a very wide range of finishes and is certified according to the ANSI Z97.1 and UNI EN12150 safety standards (except for 533. retinato). There are stoneware and wood veneer doors in different finishes as well. It is possible to mount three types of closure (without lock, with cylinder twist lock, with pawl) and a choice of handles or knobs which, like the stop profiles, are supplied in the same color as the frame. The single door is also available in a flush-to-ceiling version. The entire handle unit is treated with a special sanitizing coating (tested according to ISO 22196: 2011 standard) which, by countering the bacterial proliferation, guarantees maximum hygiene and surface cleanliness.

FR

Sherazade Swing Slim Jambs Patchwork une porte battante simple ou double sur mesure, qui se distingue par sa grande propreté formelle, avec des mini-profilés de butée télescopiques et des charnières pivotantes réglables. Une porte de grande élégance et soin des détails, dont la surface est divisée en quatre encarts, dans lesquels différents types de verre trempé monolithique 6 mm ou stratifié 3 + 3 mm peuvent être positionnés. Ces panneaux, à travers une garniture, sont insérés au centre de profils en aluminium, fournis en cinq finitions différentes. Les verres, disponibles dans une très large gamme de finitions, sont certifiés selon les normes de sécurité ANSI Z97.1 et UNI ENI 2150. Panneaux en grès ou en bois en différentes finitions et essences sont également disponibles. Il est possible d'équiper trois types de serrure (sans serrure, à cylindre, avec loqueteau) et de choisir entre poignée ou pommeau qui, comme les profils de butée, sont fournis dans la même finition que le cadre. La porte simple est également disponible dans la version au ras du plafond. L'ensemble de la poignée est traité avec une peinture assainissante spéciale (testée selon la norme ISO 22196 : 2011) qui, en luttant contre la prolifération bactérienne, garantit une hygiène et une propreté de surface maximales.



DE

Sherazade Swing Slim Jambs Patchwork ist eine nach Maß angefertigte Einzel- oder Doppeldrehtür, die sich durch große formale Sauberkeit auszeichnet, mit teleskopischen Mini-Anschlagprofilen (Mini-Pfosten) und verstellbaren Zapfenscharnieren. Eine Tür von großer Eleganz und Sorgfalt zum Detail, deren Oberfläche auf vier Felder aufgeteilt ist, wo unterschiedliche Glastypologien von 6 mm starken monolithischem gehärtetem Gläsern oder 3 + 3 mm starken beschichteten Gläsern eingebaut werden können. Diese Paneele werden mittels einer Dichtung in der Mitte eines Aluminiumrahmens eingesetzt, der in fünf verschiedenen Ausführungen geliefert wird. Die Gläser, die in einer sehr breiten Palette von Ausführungen erhältlich sind, sind gemäß ANSI Z97.1 und UNI ENI 2150 Sicherheitsvorschriften zertifiziert (mit Ausnahme von 533. retinato). Feinsteinzeug- und Holzpaneele in verschiedenen Ausführungen und Varianten sind ebenfalls erhältlich. Es ist möglich, drei Schlosstypen (ohne Blockierung, mit Zylinder, mit Sperrklinke) einzusetzen und zwischen Türgriff oder Knauf zu wählen, die wie die Anschlagprofile in der gleichen Ausführung wie der Rahmen geliefert werden. Die Einzeldrehtür ist auch in der deckenbündigen Version erhältlich. Die gesamte Griffeinheit ist mit einem speziellen Desinfektionslack (getestet nach ISO 22196:2011 Vorschrift) behandelt, der durch die Bekämpfung der Bakterienvermehrung die höchste Hygiene und Oberflächenreinheit garantiert.

ES

Sherazade Swing Slim Jambs Patchwork es una puerta abatible simple o doble hecha a medida, que destaca por su gran limpieza formal, con mini-perfiles telescópicos y bisagras pivotantes regulables. Una puerta con gran elegancia y atención al detalle, cuya superficie se divide en cuatro cuadrados, en los que se encuentran diferentes tipos de vidrio monolítico templado 6 mm o laminado 3 + 3 mm. Estos paneles, a través de una junta, se insertan en el centro de los perfiles de aluminio, suministrados en cinco acabados diferentes. Los cristales, disponibles en una amplia gama de acabados, están certificados según las normas de seguridad ANSI Z97.1 y UNI ENI 2150 (a excepción del 533. retinato). También están disponibles los paneles en gres o madera, con diferentes acabados y esencias. Es posible montar tres tipos de cerraduras (sin cerradura, con cilindro, con trinquete) y elegir entre tirador o pomo que, al igual que los perfiles de tope, se suministran en el mismo acabado que el marco. La puerta simple también está disponible en la versión empotrada al techo. Toda la unidad de empuñadura está tratada con una pintura desinfectante especial (probada según la norma ISO 22196: 2011) que, contrarresta la proliferación bacteriana garantizando la máxima higiene y limpieza de superficies.

Sherazade Swing Slim Jambs Patchwork

Design Piero Lissoni

PORTA BATTENTE RASOMURO / SWING DOOR WITH CONCEALED FRAME

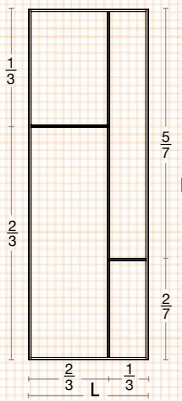
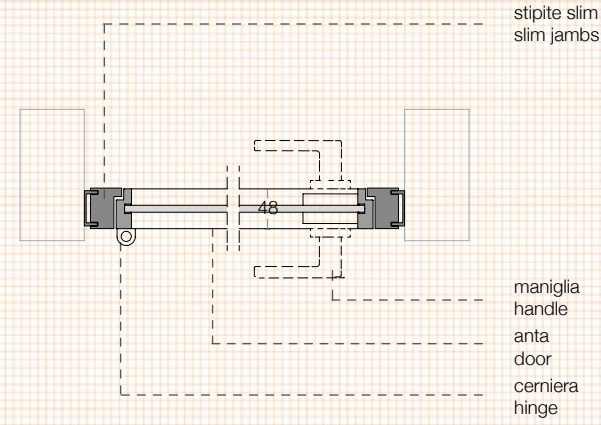
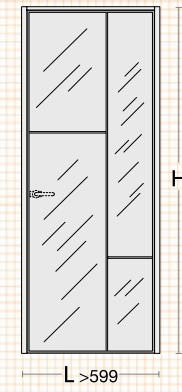

codice / code :
SSJFP01

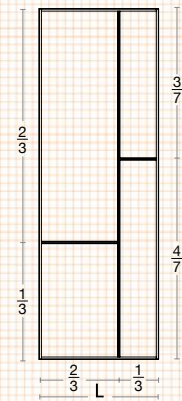

codice / code :
SSJFP02

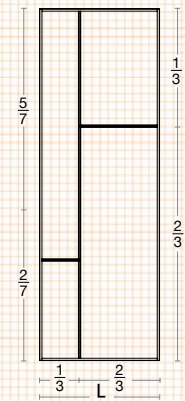

codice / code :
SSJFP03

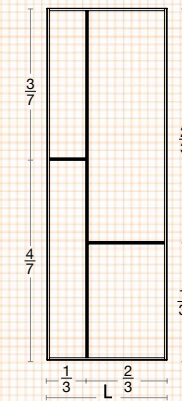

codice / code :
SSJFP04

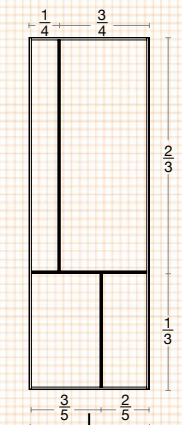

codice / code :
SSJFP05

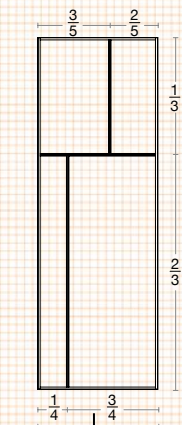

codice / code :
SSJFP06

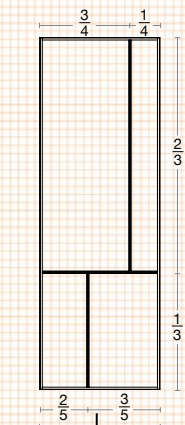

codice / code :
SSJFP07

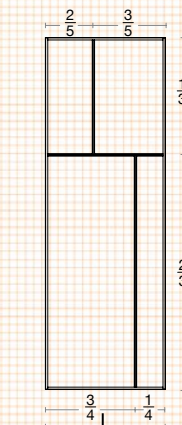

codice / code :
SSJFP08

IPOTESI PROGETTUALI / PROJECT CONFIGURATIONS

tirare sinistra / left pull

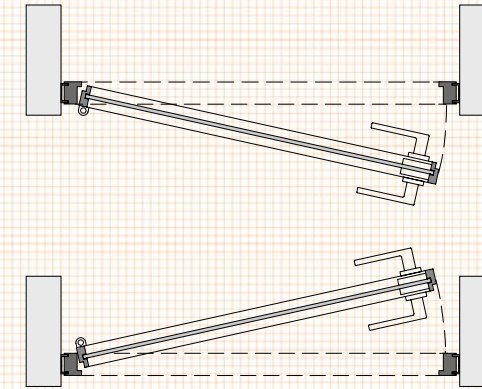

tirare destra / right pull

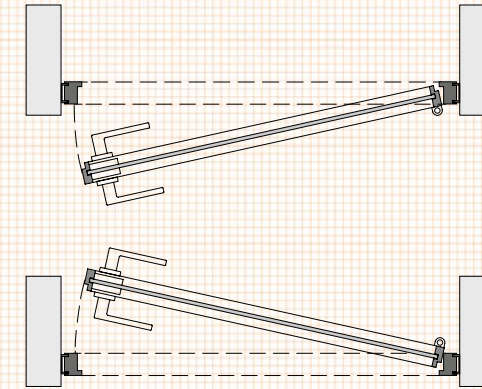

spingere sinistra / left push

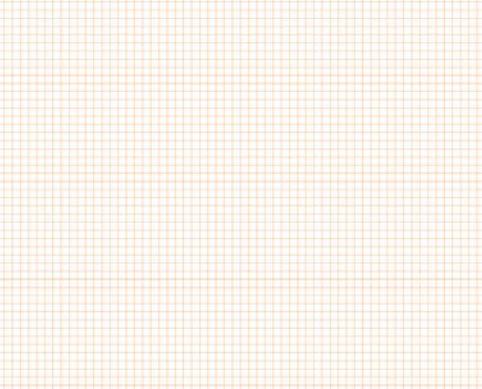

spingere destra / right push

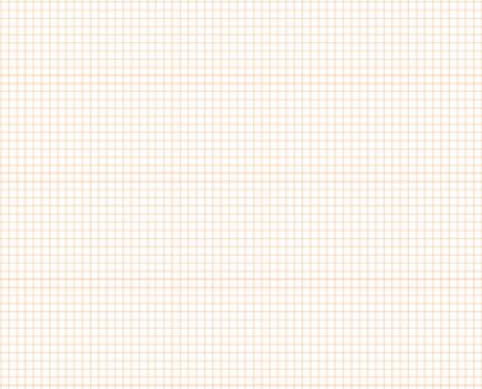

Sherazade Swing Slim Jambs Patchwork

Design Piero Lissoni

MANIGLIE SHERAZADE SWING SLIM JAMBS PATCHWORK / HANDLES SHERAZADE SWING SLIM JAMBS PATCHWORK

maniglia senza blocco /
handle without block

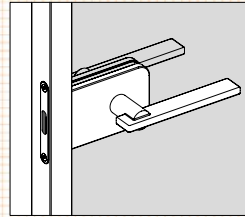

codice / code :
LSSBA

maniglia con cilindro /
handle with cylinder lock

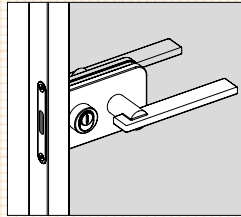

codice / code :
LSCYA

maniglia con nottolino A /
handle with revolving plug A

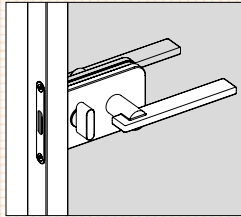

codice / code :
LSCNA

maniglia con nottolino B /
handle with revolving plug B

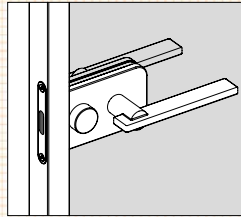

codice / code :
LSCNA

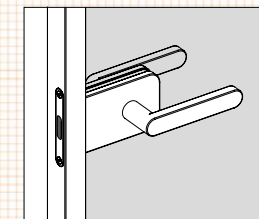

codice / code :
LSSBB

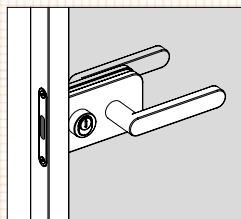

codice / code :
LSCYB

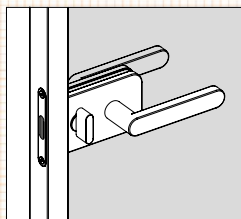

codice / code :
LSCNB

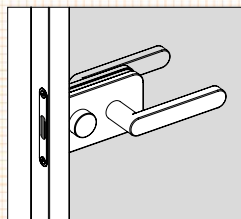

codice / code :
LSCNB

POMOLI SHERAZADE SWING SLIM JAMBS PATCHWORK / KNOBS SHERAZADE SWING SLIM JAMBS PATCHWORK

pomolo senza blocco /
knob without block

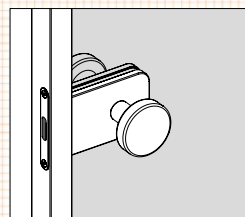

codice / code :
PSSB

pomolo con cilindro /
knob with cylinder lock

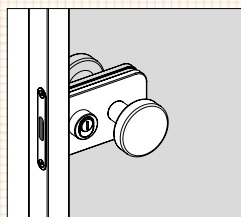

codice / code :
PSCY

pomolo con nottolino A /
knob with revolving plug A

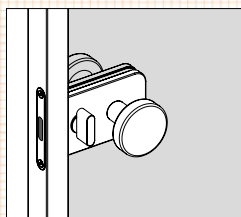

codice / code :
PSCN

pomolo con nottolino B /
knob with revolving plug B

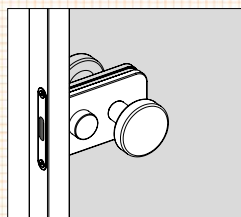

codice / code :
PSCNN

Sherazade Double Swing Slim Jambs Patchwork

Design Piero Lissoni

PORTA BATTENTE RASOMURO / SWING DOOR WITH CONCEALED FRAME

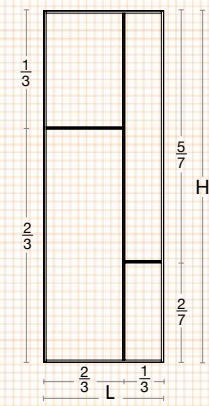
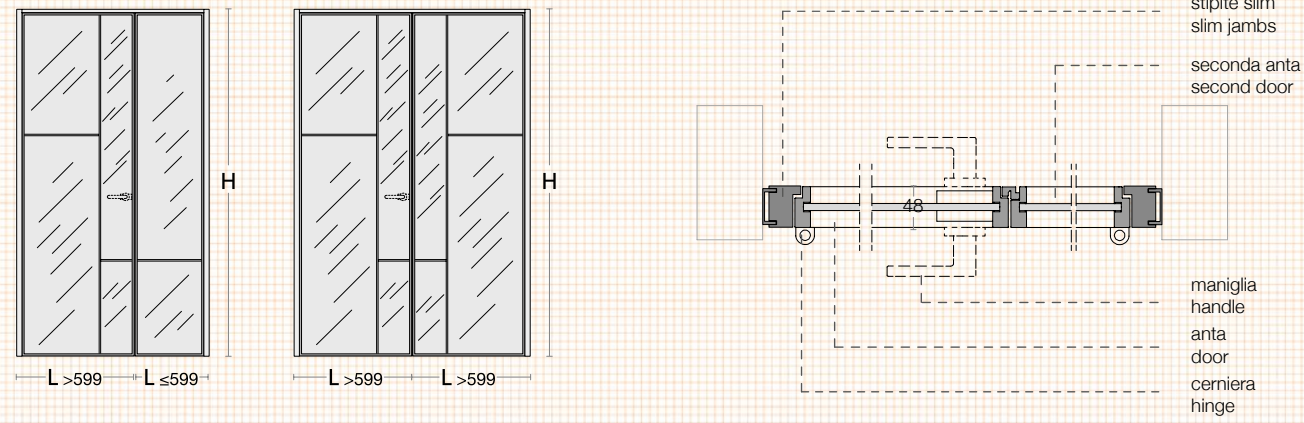

codice / code :
SSJFP01D

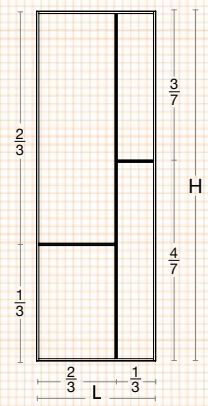

codice / code :
SSJFP02D

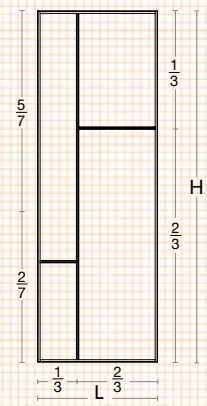

codice / code :
SSJFP03D

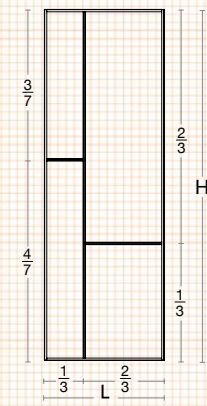

codice / code :
SSJFP04D

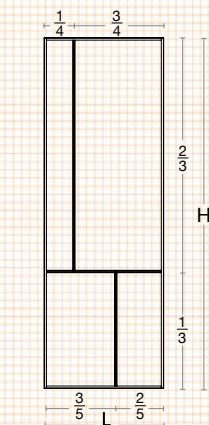

codice / code :
SSJFP05D

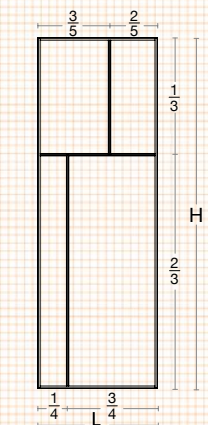

codice / code :
SSJFP06D

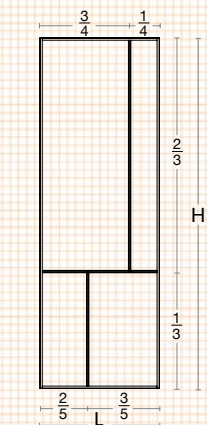

codice / code :
SSJFP07D

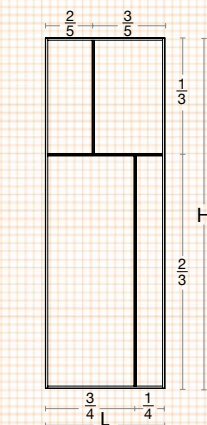

codice / code :
SSJFP08D

CONFIGURAZIONE PORTA / CONFIGURATION DOOR

opzioni seconda
anta L ≤ 599 mm /
second door panel
option L ≤ 599 mm



codice / code :
SSJFP09D



codice / code :
SSJFP10D



codice / code :
SSJFP11D



codice / code :
SSJFP12D

IPOTESI PROGETTUALI / PROJECT CONFIGURATIONS

tirare sinistra / left pull

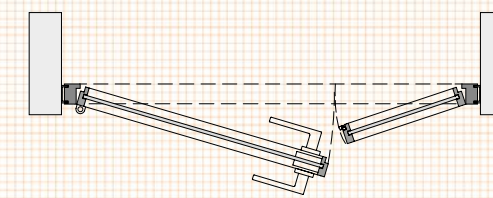

tirare destra / right pull

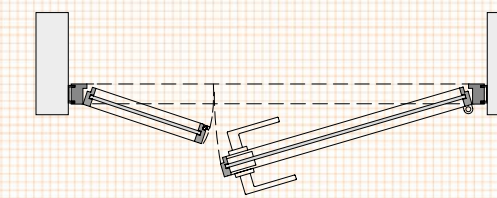

spingere sinistra / left push

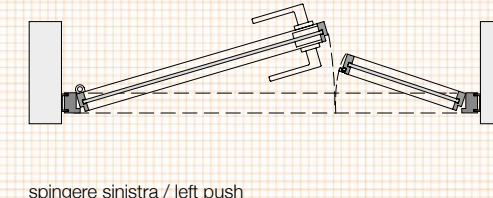

spingere destra / right push

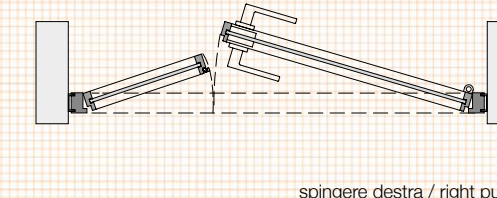

Sherazade Double Swing Slim Jambs Patchwork

Design Piero Lissoni

MANIGLIE SHERAZADE DOUBLE WING SLIM JAMBS PATCHWORK / HANDLES SHERAZADE DOUBLE SWING SLIM JAMBS PATCHWORK

maniglia senza blocco /
handle without block

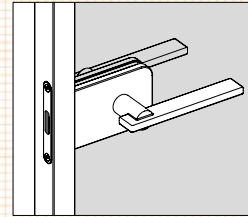

codice / code :
LSSBA

maniglia con cilindro /
handle with cylinder lock

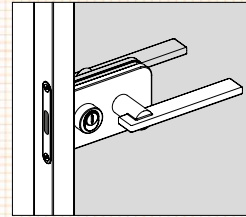

codice / code :
LSCYA

maniglia con nottolino A /
handle with revolving plug A

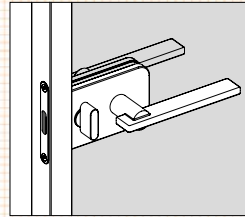

codice / code :
LSCNA

maniglia con nottolino B /
handle with revolving plug B

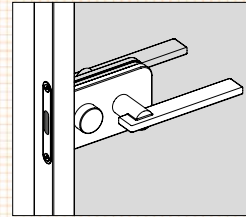

codice / code :
LSCNNA

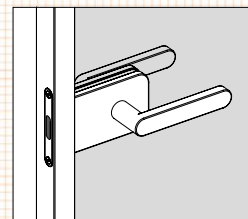

codice / code :
LSSBB

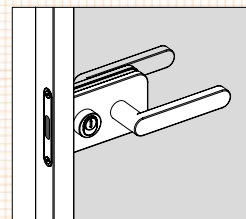

codice / code :
LSCYB

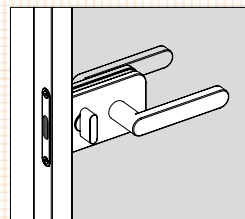

codice / code :
LSCNB

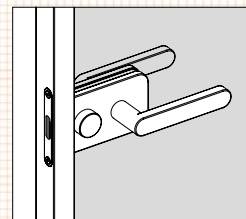

codice / code :
LSCNNB

POMOLI SHERAZADE SWING SLIM JAMBS PATCHWORK / KNOBS SHERAZADE SWING SLIM JAMBS PATCHWORK

pomolo senza blocco /
knob without block

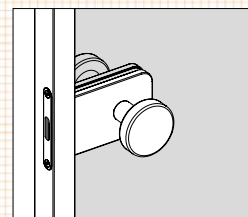

codice / code :
PSSB

pomolo con cilindro /
knob with cylinder lock

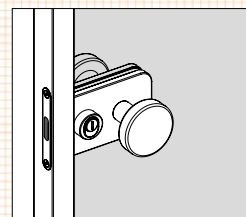

codice / code :
PSCY

pomolo con nottolino A /
knob with revolving plug A

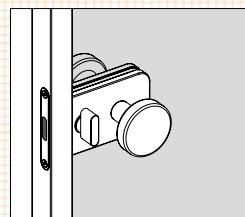

codice / code :
PSCN

pomolo con nottolino B /
knob with revolving plug B

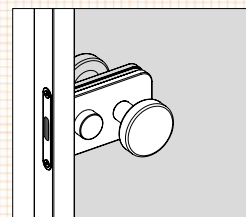

codice / code :
PSCNN

IT

Aladin Swing Slim Jambs Mono è una porta singola o doppia a battente prodotta su misura, con mini-profilo di battuta telescopici e cerniere a perno regolabili.

Un vetro è applicato su un lato di un telaio, disponibile in cinque finiture, in modo da avere una faccia con superficie planare e l'altra con superficie arretrata rispetto alla cornice perimetrale d'alluminio. Il vetro può essere monolitico temperato 6 mm oppure stratificato 3 + 3 mm temperato, disponibile in una vastissima gamma di finiture. Tutti i vetri sono certificati secondo le normative di sicurezza ANSI Z97.1 e UNI EN12150. Sono disponibili anche pannelli in gres con diverse finiture ed essenze. È possibile montare diversi tipi di serratura e scegliere tra maniglia o pomolo che, come i profili di battuta, sono forniti nella stessa finitura del telaio. La porta singola è disponibile anche nella versione filo soffitto. L'intero gruppo maniglia è trattato con una speciale vernice igienizzante (testata secondo la norma ISO 22196:2011) che, contrastando la proliferazione batterica, garantisce la massima igiene e pulizia delle superfici.

EN

Aladin Swing Slim Jambs Mono is a custom-made single or double swing door with slim telescopic profiles and adjustable hinges. A glass is applied on one side of an aluminum frame, so as to have a face with a flush surface and another surface rebated from the perimeter aluminum frame. The glass can be monolithic tempered 6mm or laminated 3+3mm, available in a very wide range of finishes. All the glass is certified according to the ANSI Z97.1 and UNI EN12150 safety standards. There are stoneware and wood veneer doors in different finishes as well.

It is possible to mount different types of closure and a choice of handles or knobs which, like the stop profiles, are supplied in the same color as the frame. The single door is also available in a flush-to-ceiling version.

The entire handle unit is treated with a special sanitizing coating (tested according to ISO 22196: 2011 standard) which, by countering the bacterial proliferation, guarantees maximum hygiene and surface cleanliness.

FR

Aladin Swing Slim Jambs Mono est une porte battante simple ou double sur mesure avec des mini-profilés de butée télescopiques et des charnières pivotantes réglables. Un cristal est appliqué sur un côté d'un cadre, de façon à avoir un côté avec une surface plane et l'autre avec une surface en retrait du cadre périmétrique en aluminium.

Le cristal peut être trempé monolithique 6 mm ou feuilleté 3 + 3 mm trempé, disponible dans une large gamme de finitions. Toutes les verres sont certifiées selon les normes de sécurité ANSI Z97.1 et UNI EN12150. Panneaux en grès avec différentes finitions sont également disponibles. C'est possible monter différents types de serrure et de choisir entre poignée ou pommeau qui, comme les profilés de butée, sont fournis dans la même finition que le cadre. La porte simple est également disponible dans la version au ras du plafond. L'ensemble de la poignée est traité avec une peinture assainissante spéciale (testée selon la norme ISO 22196 : 2011) qui, en luttant contre la prolifération bactérienne, garantit une hygiène et une propreté de surfaces maximales.



DE

Aladin Swing Slim Jambs Mono ist eine nach Maß angefertigte Einzel- oder Doppeldrehtür mit teleskopischen Mini-Anschlagprofilen (Mini- Pfosten) und verstellbaren Zapfenscharnieren. Der umlaufende Aluminiumrahmen, erhältlich in fünf Ausführungen, ist mit einer einseitigen Glasfüllung versehen, die einseitig bündig mit dem Rahmen abschließt und auf der Gegenseite zurückspringt. Das Glas kann 6 mm stark monolithisch gehärtet oder 3 + 3 mm stark beschichtet sein und ist in einer sehr breiten Palette von Ausführungen erhältlich. Alle Gläser sind gemäß ANSI Z97.1 und UNI EN12150 Sicherheitsvorschriften zertifiziert Feinsteinzeug- und Holzpaneele in verschiedenen Ausführungen und Varianten sind ebenfalls erhältlich. Es ist möglich, unterschiedliche Schlosstypen einzusetzen und zwischen Türgriff oder Knauf zu wählen, die wie die Anschlagprofile in der gleichen Ausführung wie der Rahmen geliefert werden. Die Einzeldrehtür ist auch in der deckenbündigen Version erhältlich. Die gesamte Griffereinheit ist mit einem speziellen Desinfektionslack (getestet nach ISO 22196:2011 Vorschrift) behandelt, der durch die Bekämpfung der Bakterienvermehrung die höchste Hygiene und Oberflächenreinheit garantiert.

ES

Aladin Swing Slim Jambs Mono es una puerta abatible simple o doble hecha a medida con perfiles telescópicos delgados y bisagras ajustables. Se aplica un vidrio en un lado de un marco de aluminio, de modo que tenga una cara con una superficie enrasada y otra superficie rebajada del marco de aluminio perimetral. El vidrio puede ser monolítico templado 6 mm o laminado 3 + 3 mm, disponible en una amplia gama de acabados. Todo el vidrio está certificado según las normas de seguridad ANSI Z97.1 y UNI EN12150. También hay puertas de gres y chapa de madera en diferentes acabados. Es posible montar diferentes tipos de cierre y una selección de tiradores o pomos que, al igual que los perfiles de tope, se suministran en el mismocolor que el marco. La puerta simple también está disponible en versión empotrada al techo. Toda la unidad de empuñadura está tratada con un recubrimiento higienizante especial (testado según norma ISO 22196: 2011) que, al contrarrestar la proliferación bacteriana, garantiza la máxima higiene y limpieza de la superficie.

Aladin Swing Slim Jambs Mono

Design Piero Lissoni

PORTA BATTENTE CON MINI STIPITE / SWING DOOR WITH SLIM JAMBS

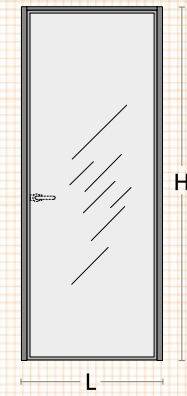

codice / code :
ASJM

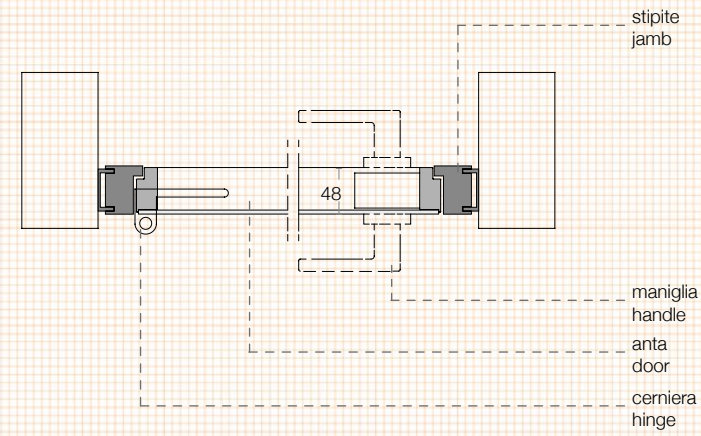

stipite jamb
maniglia handle
anta door
cerniera hinge

IPOTESI PROGETTUALI / PROJECT CONFIGURATIONS

tirare sinistra / left pull

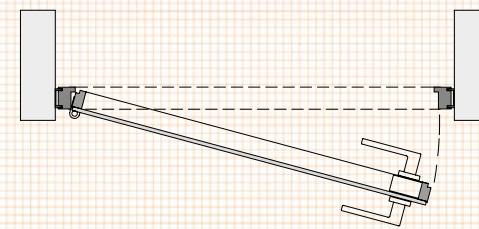

tirare destra / right pull

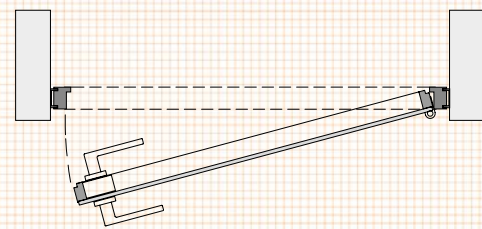

spingere sinistra / left push

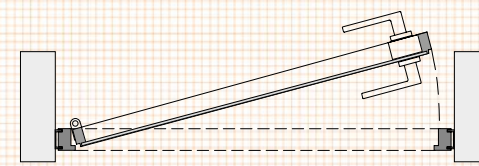

spingere destra / right push

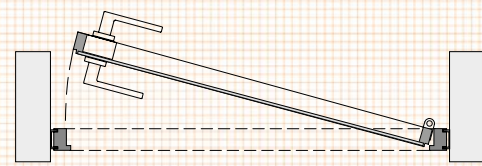

MANIGLIE ALADIN SWING SLIM JAMBS MONO / HANDLES ALADIN SWING SLIM JAMBS MONO

maniglia senza blocco /
handle without block

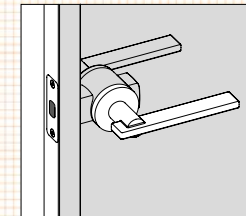

codice / code :
LSBA

maniglia con chiusura privacy /
handle with privacy lock

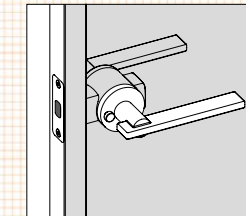

codice / code :
LCPA

maniglia con chiave /
handle with key lock

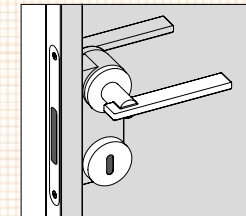

codice / code :
LCCA

maniglia con cilindro /
handle with cylinder lock

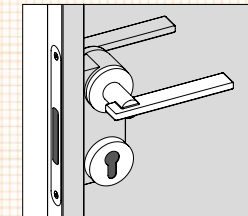

codice / code :
LCYA

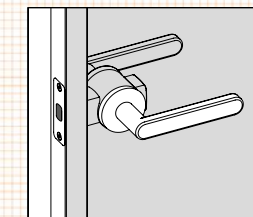

codice / code :
LSBB

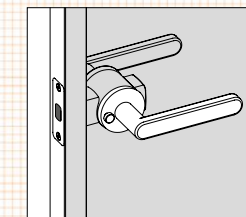

codice / code :
LCPB

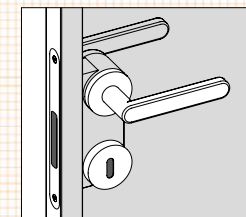

codice / code :
LCCB

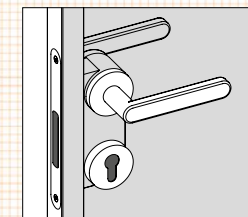

codice / code :
LCYB

POMOLI ALADIN SWING SLIM JAMBS MONO / KNOBS ALADIN SWING SLIM JAMBS MONO

pomolo senza blocco /
knob without block

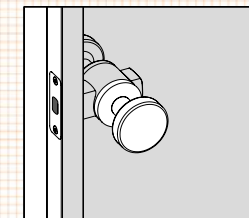

codice / code :
PSB

pomolo con chiusura privacy /
knob with privacy lock

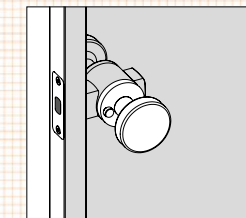

codice / code :
PCP

pomolo con chiave /
knob with key lock

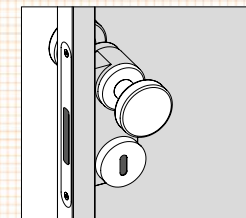

codice / code :
PCC

pomolo con cilindro /
knob with cylinder lock

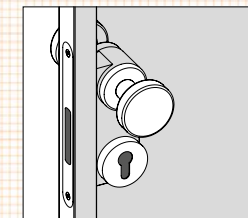

codice / code :
PCY

Aladin Double Swing Slim Jambs Mono

Design Piero Lissoni

PORTA BATTENTE CON MINI STIPITE / SWING DOOR WITH SLIM JAMBS

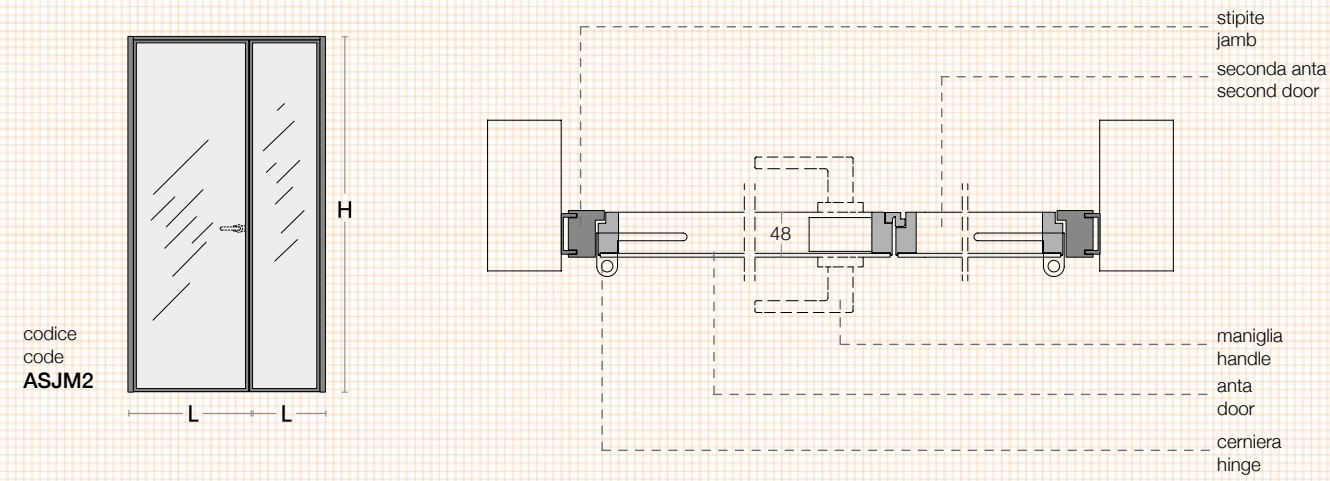

IPOTESI PROGETTUALI / PROJECT CONFIGURATIONS

tirare sinistra / left pull

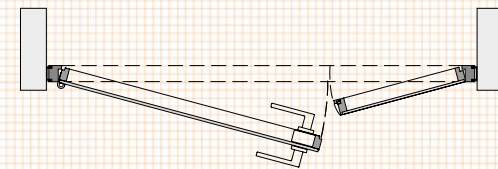

tirare destra / right pull

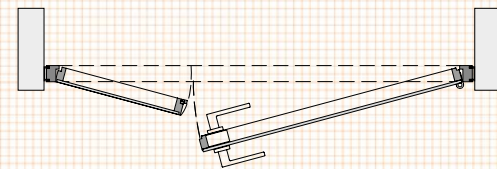

spingere sinistra / left push

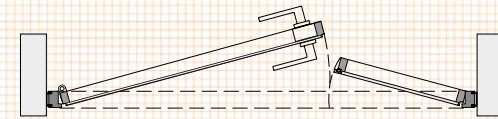

spingere destra / right push

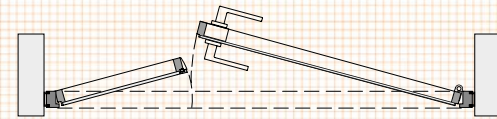

MANIGLIE ALADIN DOUBLE SWING SLIM JAMBS MONO / HANDLES ALADIN DOUBLE SWING SLIM JAMBS MONO

maniglia senza blocco /
handle without block

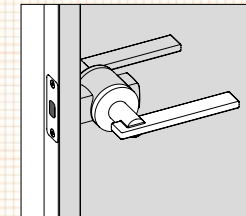

codice / code :
LSBA

maniglia con chiusura privacy /
handle with privacy lock

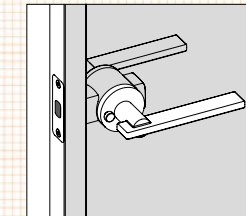

codice / code :
LCPA

maniglia con chiave /
handle with key lock

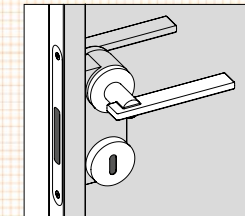

codice / code :
LCCA

maniglia con cilindro /
handle with cylinder lock

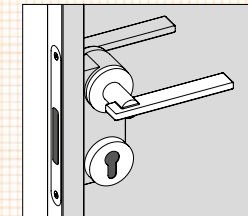

codice / code :
LCYA

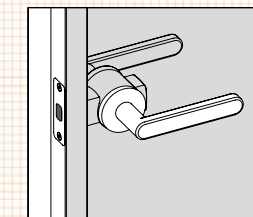

codice / code :
LSBB

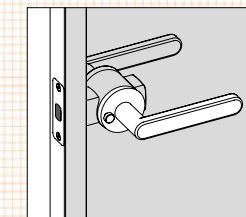

codice / code :
LCPB

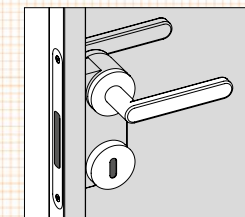

codice / code :
LCCB

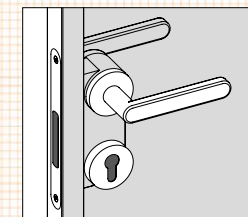

codice / code :
LCYB

POMOLI ALADIN DOUBLE SWING SLIM JAMBS MONO / KNOBS ALADIN DOUBLE SWING SLIM JAMBS MONO

pomolo senza blocco /
knob without block

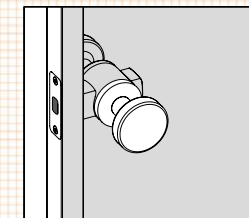

codice / code :
PSB

pomolo con chiusura privacy /
knob with privacy lock

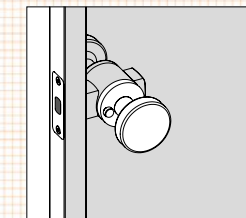

codice / code :
PCP

pomolo con chiave /
knob with key lock

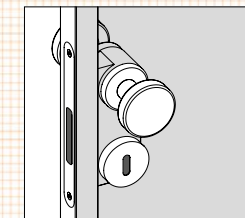

codice / code :
PCC

pomolo con cilindro /
knob with cylinder lock

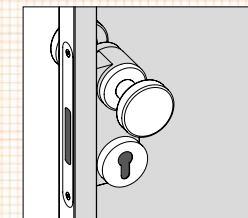

codice / code :
PCY

IT

Aladin Swing Slim Jambs Duo è una porta singola o doppia a battente prodotta su misura, con mini-profili di battuta telescopici e cerniere a perno regolabili. Vetri temperati spessore 4 mm sono applicati su entrambe le facce di un telaio in alluminio, disponibile in cinque finiture, in modo da formare un volume con una camera d'aria interna. I vetri, disponibili in un'ampia gamma di finiture, sono certificati secondo le normative di sicurezza ANSI Z97.1 e UNI EN12150. Sono disponibili anche pannelli in gres o in legno, con diverse finiture ed essenze.

È possibile montare diversi tipi di serratura e scegliere tra maniglia o pomolo che, come i profili di battuta, sono forniti nella stessa finitura del telaio. La porta singola è disponibile anche nella versione filo soffitto. L'intero gruppo maniglia è trattato con una speciale vernice igienizzante (testata secondo la norma ISO 22196:2011) che, contrastando la proliferazione batterica, garantisce la massima igiene e pulizia delle superfici.

EN

Aladin Swing Slim Jambs Duo is a custom-made single or double swing door with slim telescopic profiles and adjustable hinges. 4mm thick tempered glass is applied on both faces of an aluminum frame, available in five finishes, forming a perceived volume with an internal air chamber. The glass is available in a very wide range of finishes and is certified according to the ANSI Z97.1 and UNI EN12150 safety standards. There are stoneware and wood veneer doors in different finishes as well. It is possible to mount different types of closure and a choice of handles or knobs which, like the stop profiles, are supplied in the same color as the frame. The single door is also available in a flush to ceiling version. The entire handle group is treated with a special sanitizing coating (tested according to ISO 22196: 2011 standard) which, by countering the bacterial proliferation, guarantees maximum hygiene and surface cleanliness.

FR

Aladin Swing Slim Jambs Duo est une porte battante simple ou double sur mesure avec des mini-profils de butée télescopiques et des charnières pivotantes réglables. Des cristaux trempés de 4 mm d'épaisseur sont appliqués sur les deux côtés d'un cadre en aluminium, disponible en cinq finitions, de manière à former un volume d'air intérieur. Les verres, disponibles dans une large gamme de finitions, sont certifiés selon les normes de sécurité ANSI Z97.1 et UNI EN12150. Panneaux en grès ou en bois en différentes finitions et essences sont également disponibles. C'est possible monter différents types de serrures et de choisir entre poignée ou pommeau qui, comme les profils de butée, sont fournis dans la même finition que le cadre. La porte simple est également disponible dans la version au ras du plafond. L'ensemble de la poignée est traité avec une peinture assainissante spéciale (testée selon ISO 22196 : 2011) qui, en luttant contre la prolifération bactérienne, garantit une hygiène et une propreté de surfaces maximales.



DE

Aladin Swing Slim Jambs Duo ist eine nach Maß angefertigte Einzeloder Doppeldrehtür mit teleskopischen Mini-Anschlagprofilen (Mini- Pfosten) und verstellbaren Zapfenscharnieren. Die Glasfüllungen sind je 4 mm stark und gehärtet und sie werden auf beiden Seiten des Aluminiumrahmens, der in fünf Ausführungen erhältlich ist, verfügbar ist, angebracht. Zwischen den Füllungen besteht einen Luftraum. Alle Gläser sind gemäß ANSI Z97.1 und UNI ENI 2150 Sicherheitsvorschriften zertifiziert Feinsteinzeug- und Holzpaneele in verschiedenen Ausführungen und Varianten sind ebenfalls erhältlich. Es ist möglich, unterschiedliche Schlosstypen einzusetzen und zwischen Türgriff oder Knauf zu wählen, die wie die Anschlagprofile in der gleichen Ausführung wie der Rahmen geliefert werden. Die Einzeldrehtür ist auch in der deckenbündigen Version erhältlich. Die gesamte Griffereinheit ist mit einem speziellen Desinfektionslack (getestet nach ISO 22196:2011 Vorschrift) behandelt, der durch die Bekämpfung der Bakterienvermehrung die höchste Hygiene und Oberflächenreinheit garantiert

ES

Aladin Swing Slim Jambs Duo es una puerta abatible simple o doble hecha a medida con mini-perfiles telescópicos y bisagras pivotantes ajustables. Se aplica vidriotemplado de 4 mm de espesor a ambos lados de un marco de aluminio, disponible en cinco acabados, para formar un volumen con una cámara de aire interna. Los cristales, disponibles en una amplia gama de acabados, están certificados según las normas de seguridad ANSI Z97.1 y UNI EN12150. También están disponibles los paneles en gres o madera, con diferentes acabados y esencias. Es posible montar diferentes tipos de cerraduras y elegir entre tirador o pomo que, al igual que los perfiles de tope, se suministran en el mismo acabado que el marco. La puerta simple también está disponible en la versión empotrada al techo. Toda la unidad de empuñadura está tratada con una pintura higienizante especial (testada según ISO 22196: 2011) que, al contrarrestar la proliferación bacteriana, garantiza la máxima higiene y limpieza de la superficie.

Aladin Swing Slim Jambs Duo

Design Piero Lissoni

PORTA BATTENTE CON MINI STIPITE / SWING DOOR WITH SLIM JAMBS

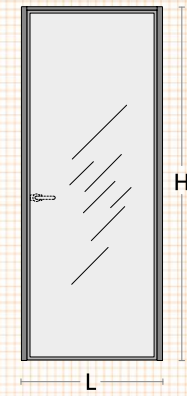

codice / code :
ASJD

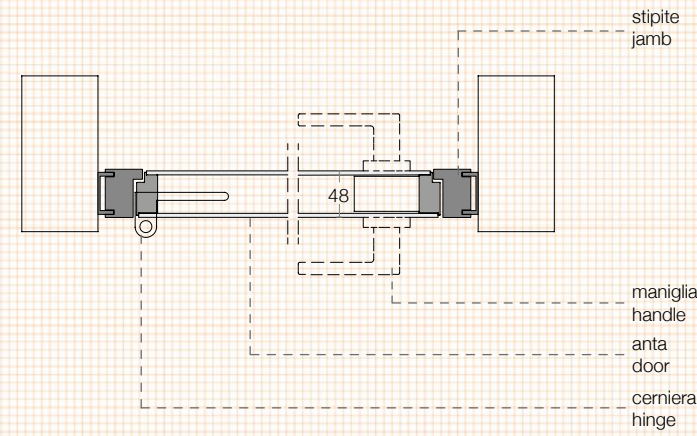

stipite jamb
maniglia handle
anta door
cerniera hinge

IPOTESI PROGETTUALI / PROJECT CONFIGURATIONS

tirare sinistra / left pull

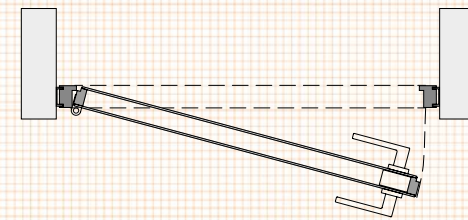

tirare destra / right pull

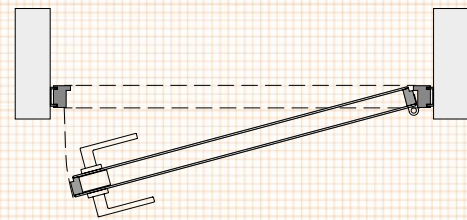

spingere sinistra / left push

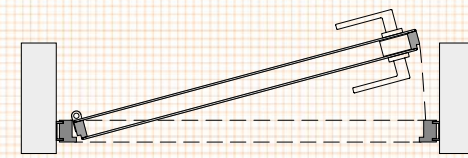

spingere destra / right push

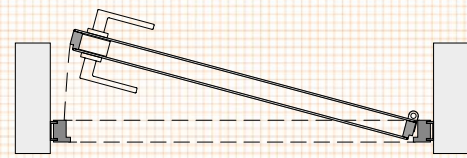

MANIGLIE ALADIN SWING SLIM JAMBS DUO / HANDLES ALADIN SWING SLIM JAMBS DUO

maniglia senza blocco /
handle without block

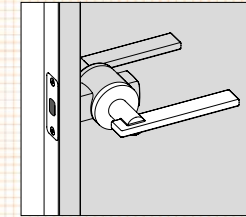

codice / code :
LSBA

maniglia con chiusura privacy /
handle with privacy lock

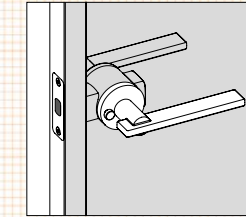

codice / code :
LCPA

maniglia con chiave /
handle with key lock

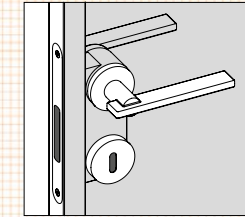

codice / code :
LCCA

maniglia con cilindro /
handle with cylinder lock

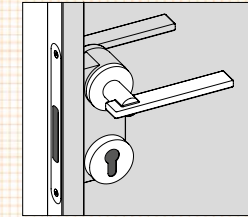

codice / code :
LCYA

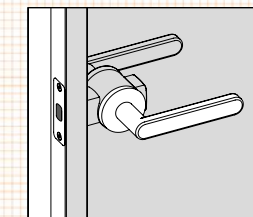

codice / code :
LSBB

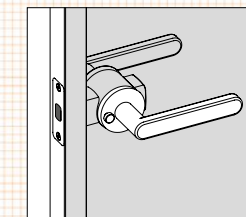

codice / code :
LCPB

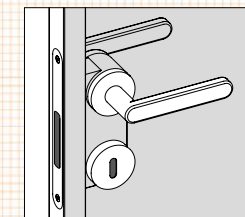

codice / code :
LCCB

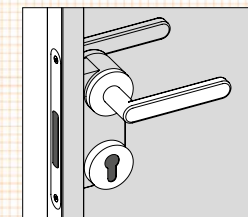

codice / code :
LCYB

POMOLI ALADIN SWING SLIM JAMBS DUO / KNOBS ALADIN SWING SLIM JAMBS DUO

pomolo senza blocco /
knob without block

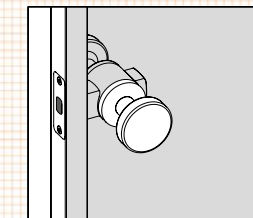

codice / code :
PSB

pomolo con chiusura privacy /
knob with privacy lock

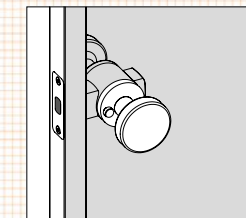

codice / code :
PCP

pomolo con chiave /
knob with key lock

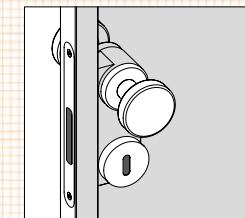

codice / code :
PCC

pomolo con cilindro /
knob with cylinder lock

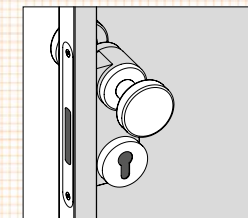

codice / code :
PCY

Aladin Double Swing Slim Jambs Duo

Design Piero Lissoni

PORTA BATTENTE CON MINI STIPITE / SWING DOOR WITH SLIM JAMBS

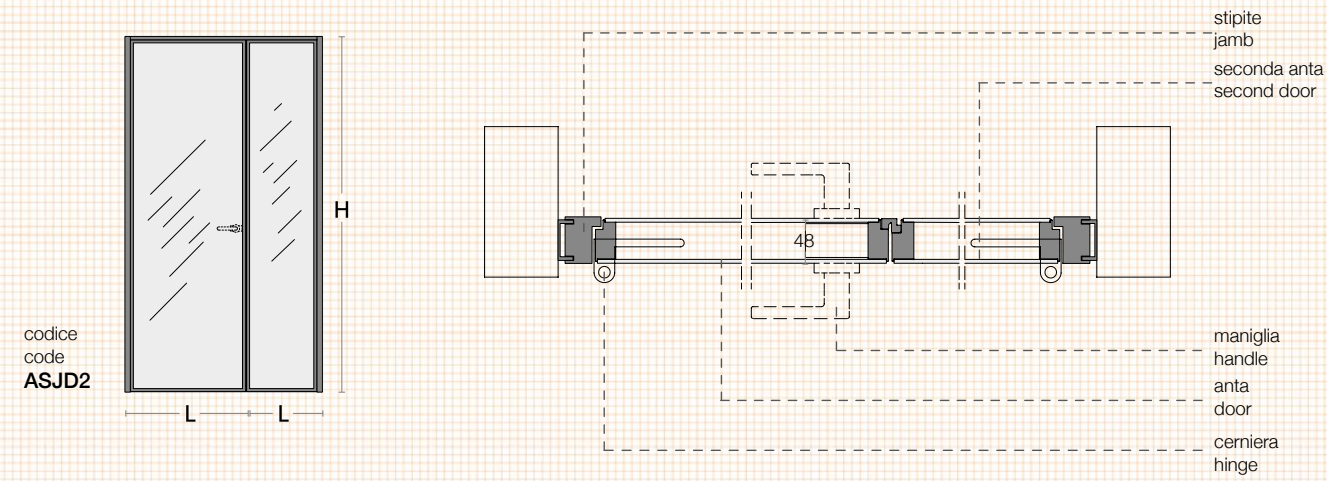

IPOTESI PROGETTUALI / PROJECT CONFIGURATIONS

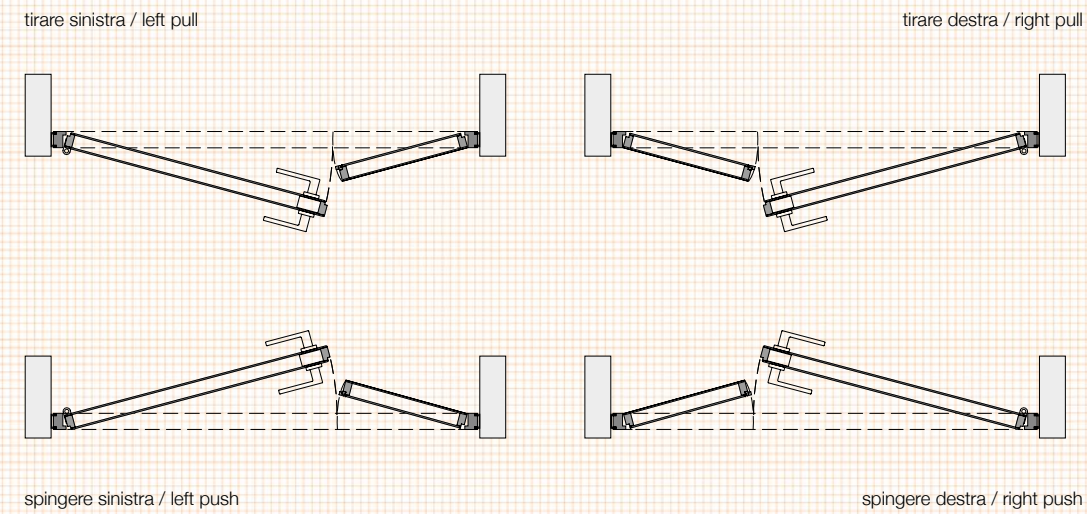

MANIGLIE ALADIN DOUBLE SWING FRAME DUO / HANDLES ALADIN DOUBLE SWING FRAME DUO

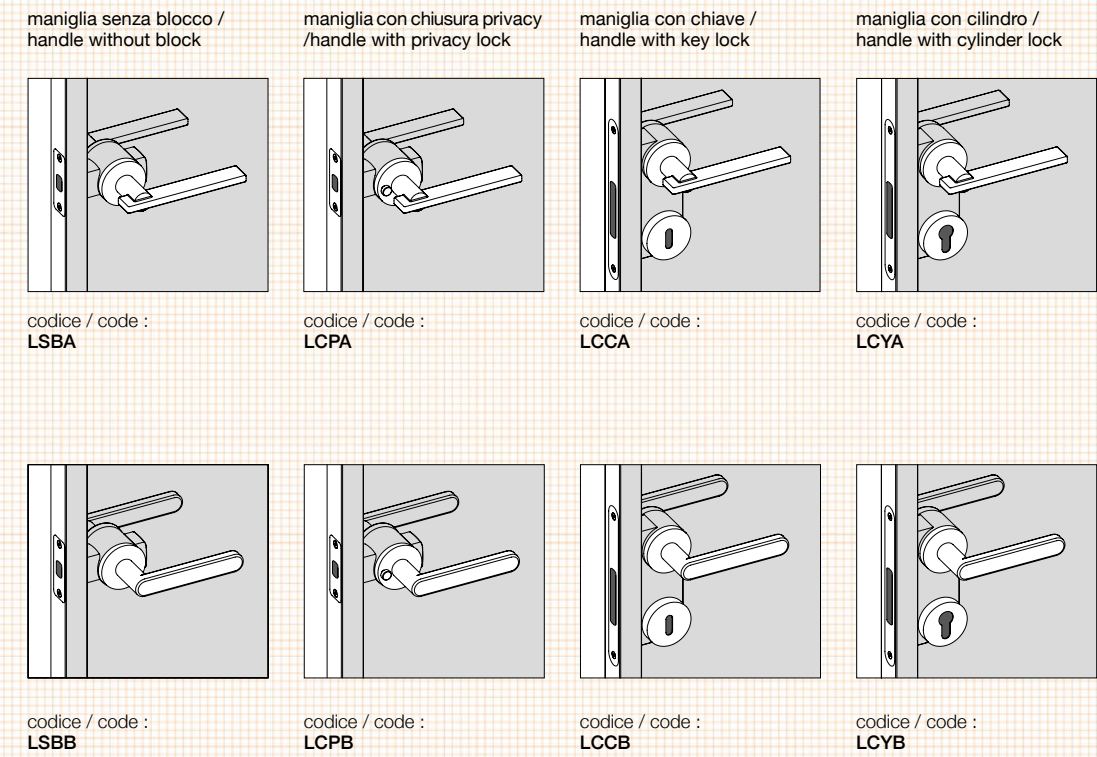

POMOLI ALADIN DOUBLE SWING FRAME DUO / KNOBS ALADIN DOUBLE SWING FRAME DUO

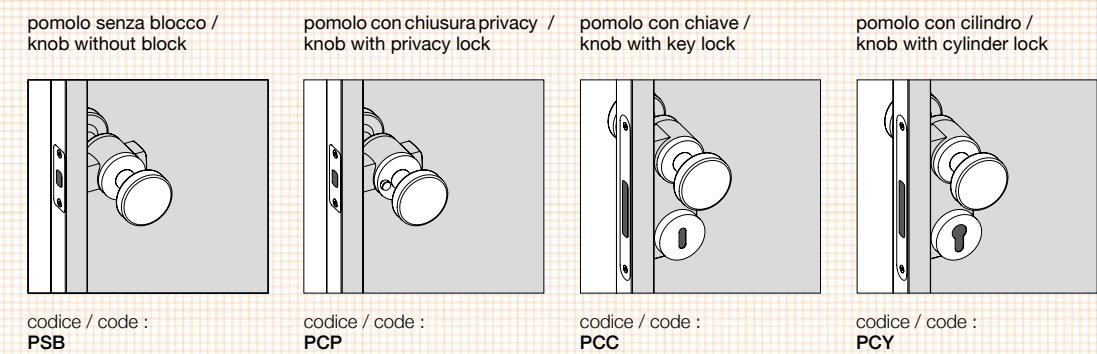

IT

Sherazade Swing Frame è una porta singola o doppia a battente prodotta su misura, che si distingue per la grande pulizia formale e la cura dei dettagli, con stipite telescopico e cerniere a perno regolabili. Un vetro temperato monolitico da 6 mm o stratificato da 3 + 3 mm è inserito tramite guarnizione in un telaio d'alluminio, fornito in cinque diverse finiture. I vetri, disponibili in una vastissima gamma di finiture, sono certificati secondo le normative di sicurezza ANSI Z97.1 e UNI ENI 2150 (ad eccezione di 533. armato). Sono disponibili anche pannelli in gres o in legno, con diverse finiture ed essenze. È possibile montare tre tipi di serratura (senza blocco, con cilindro, con nottolino) e scegliere tra maniglia o pomolo che, come lo stipite, sono forniti nella stessa finitura del telaio. L'intero gruppo maniglia è trattato con una speciale vernice igienizzante (testata secondo la norma ISO 22196:2011) che, contrastando la proliferazione batterica, garantisce la massima igiene e pulizia delle superfici.

EN

Sherazade Swing Frame is a single or double custom made swing door with a telescopic jamb and adjustable pivot hinges, which stands out for its clean lines and attention to detail. The monolithic 6 mm or laminated 3 + 3 mm thick tempered glass is inserted by means of a seal in the aluminum frame, which is supplied in five different finishes. The glasses are available in a wide range of finishes and they are certified according to the safety regulations ANSI Z97.1 and UNI ENI 2150 (with the exception of 533. armato). Panels in stoneware and in wood with different finishes and essences are available too. It is possible to assemble three kinds of lock (without block, with cylinder, with revolving plug) and choose between handle or knob and, like the jamb, they are supplied in the same finish of the frame. The entire handle set is treated with a special sanitizing varnish (tested according to ISO 22196: 2011) which, by counteracting bacterial overgrowth, guarantees maximum hygiene and cleanliness of the surfaces.

FR

Sherazade Swing Frame est une porte battante simple ou double produite sur mesure, qui ressort pour l'extrême essentialité et le soin des détails, avec cadre télescopique et charnières réglables. Un verre trempé monolithique de 6 mm ou stratifié de 3 + 3 mm est inséré par un joint dans le cadre d'aluminium, disponible en cinq finitions différentes. Les verres sont disponibles dans une large gamme de finitions, ils sont certifiés selon les normes de sécurité ANSI Z97.1 et UNI ENI 2150 (à l'exception de la finition 533. armato). Panneaux en grès et bois en différentes finitions et essences sont également disponibles. Il est possible d'équiper trois types de verrouillage (sans serrure, avec cylindre, avec verrou) et choisir parmi la poignée ou le pommeau qui, comme le montant, sont fournis dans la même finition du cadre. L'entière bloc poignée est traité avec un vernis désinfectant spécial (testé selon ISO 22196: 2011) qui, en neutralisant la prolifération bactérienne, garantit une hygiène et une propreté maximales des surfaces.



DE

Sherazade Swing Frame ist eine Einzel-oder Doppeldrehtür, nach Maß herstellt und von außergewöhnlicher Reinheit der Formen und besonderer Qualität des Details gekennzeichnet, die einen teleskopischen Pfosten und verstellbare Zapfenscharniere hat. Das Glas kann 6 mm stark monolithisch gehärtet oder 3 + 3 mm stark beschichtet sein. Es ist mittels einer Dichtung in dem Aluminiumrahmen eingesetzt, der in fünf verschiedenen Ausführungen erhältlich ist. Die Gläser sind in einer sehr weiten Serie von Ausführungen verfügbar und sind gemäß ANSI Z97.1 und UNI ENI 2150 zertifiziert (außer für die Ausführung 533. armato). Gres- und Holzpaneele in verschiedenen Ausführungen und Hölzern sind ebenfalls erhältlich. Man kann drei verschiedene Arten von Schloss (ohne Blockierung, mit Zylinder, mit Klinkenschloss) montieren und zwischen Klinke oder Knopf, in der selben Ausführung sowohl des Pfostens als auch des Rahmens wählen. Die gesamte Griffbaugruppe wird mit einem speziellen, hygienischen Lack (geprüft nach ISO 22196: 2011) behandelt, der durch die Bekämpfung des Bakterienwachstums maximale Hygiene und Sauberkeit der Oberflächen garantiert.

ES

Sherazade Swing Frame es una puerta batiente simple o doble producida a medida, que se distingue por su gran limpieza formal y atención a los detalles, con jamba telescópica y bisagras de perno regulables. Un cristal templado monolítico de 6 mm o estratificado 3 + 3 mm, está insertado por medio de una junta en el marco de aluminio, suministrado en cinco diferentes acabados. Los cristales, disponibles en una amplia gama de acabados, están certificados según las normativas de seguridad ANSI Z97.1 y UNI EN12150 (a excepción de 533. armato). Están disponibles también paneles de gres y madera con diferentes acabados y esencias. Es posible montar tres tipos de cerradura (sin bloque, con cilindro, con pasador de balancín) y elegir entre manilla o pomo, que como la jamba, están suministrados en el mismo acabado del marco. La manilla completa está tratada con un especial barniz desinfectante (probado según la norma ISO 22196:2011) que, contrastando la proliferación bacteriana, garantiza la máxima higiene y limpieza de las superficies.

Sherazade Swing Frame

Design Piero Lissoni

PORTA BATTENTE CON STIPITE / SWING DOOR WITH VISIBLE FRAME

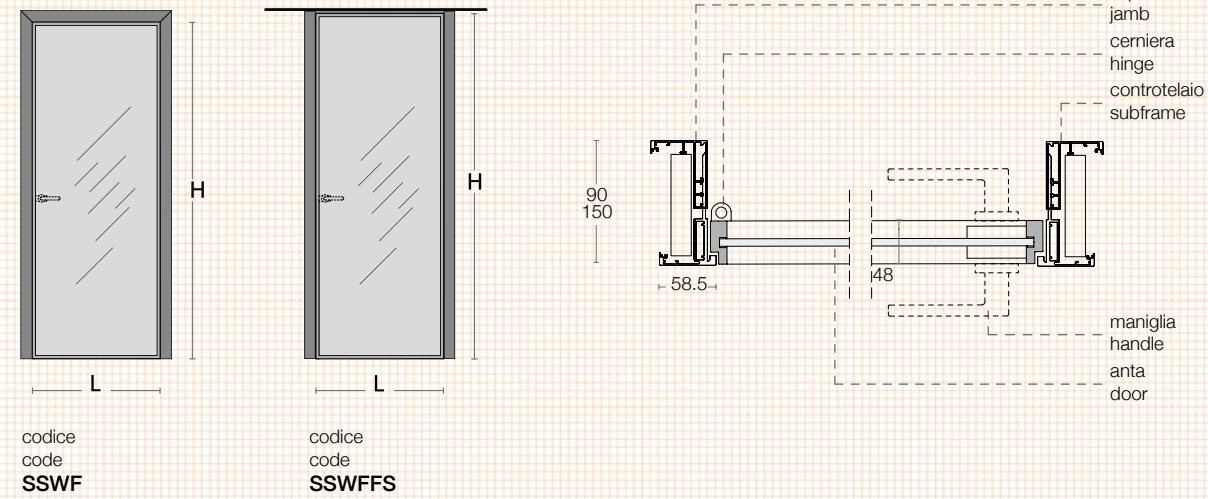

IPOTESI PROGETTUALI / PROJECT CONFIGURATIONS

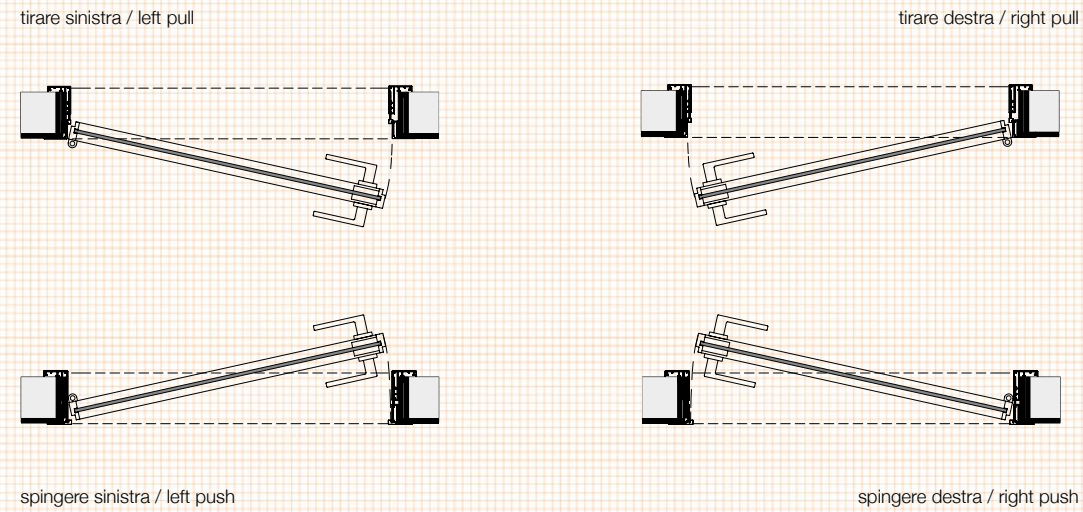

MANIGLIE SHERAZADE SWING FRAME / HANDLES SHERAZADE SWING FRAME

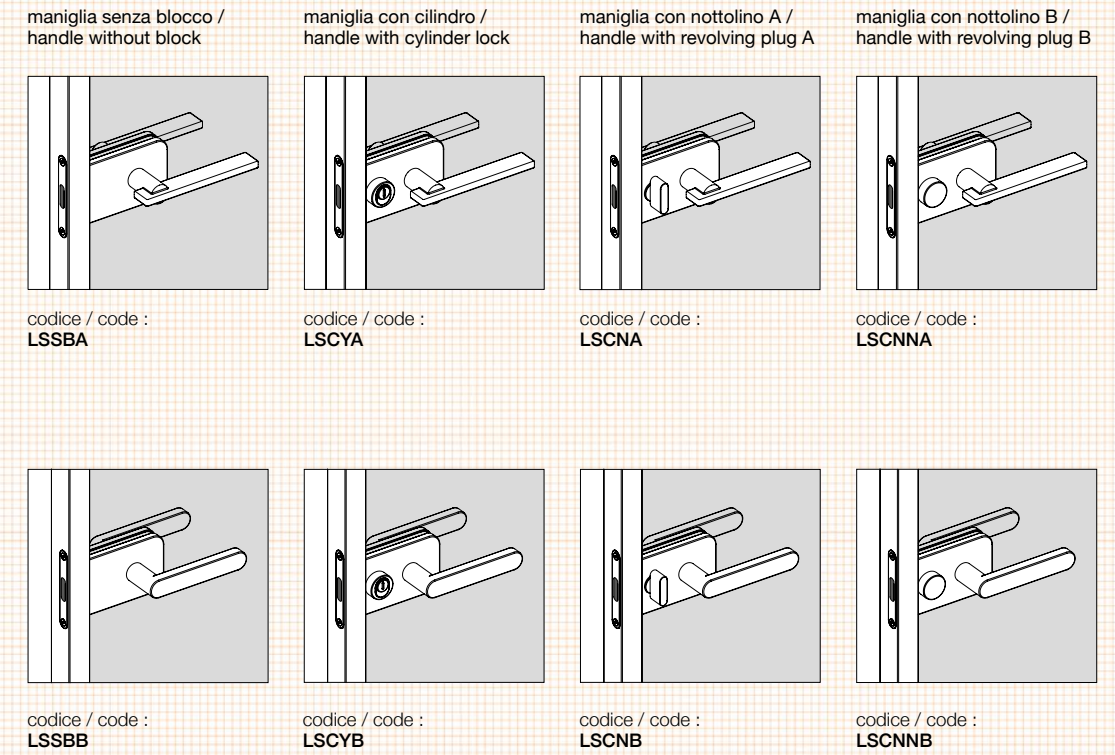

POMOLI SHERAZADE SWING FRAME / KNOBS SHERAZADE SWING FRAME

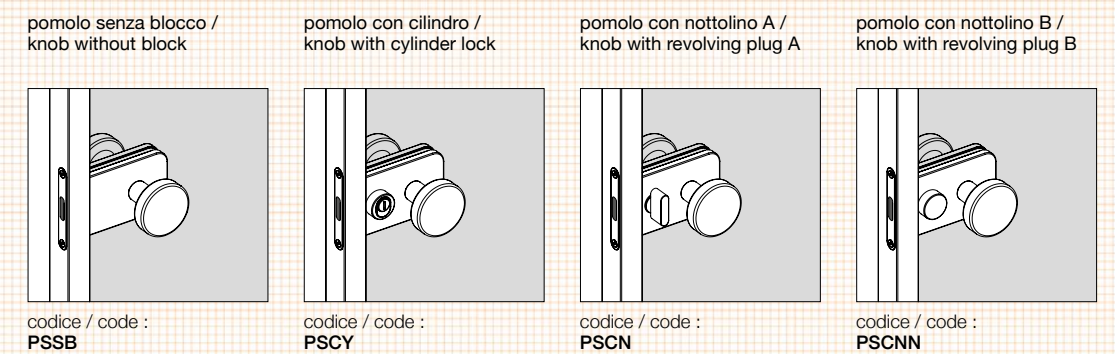

Sherazade Double Swing Frame

Design Piero Lissoni

PORTA BATTENTE RASOMURO / SWING DOOR WITH CONCEALED FRAME

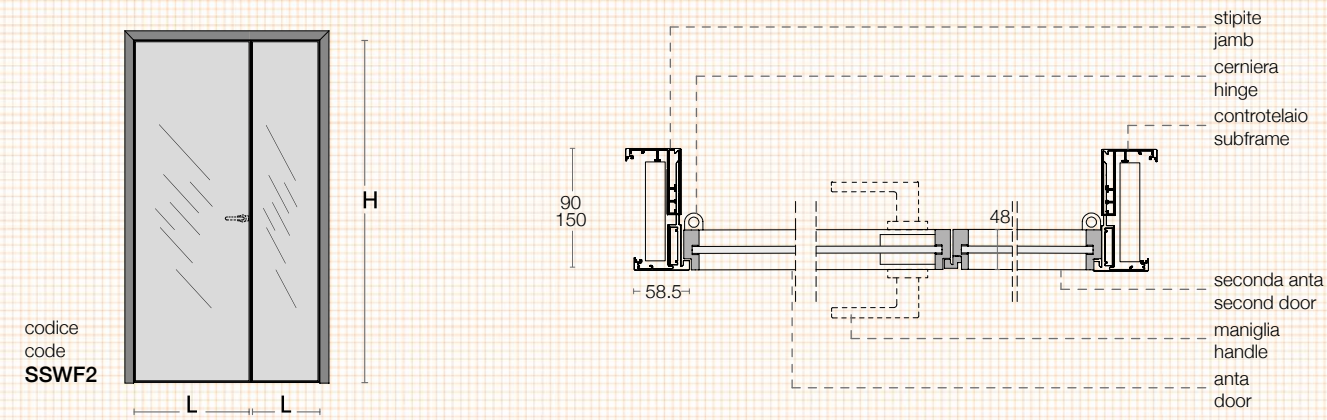

IPOTESI PROGETTUALI / PROJECT CONFIGURATIONS

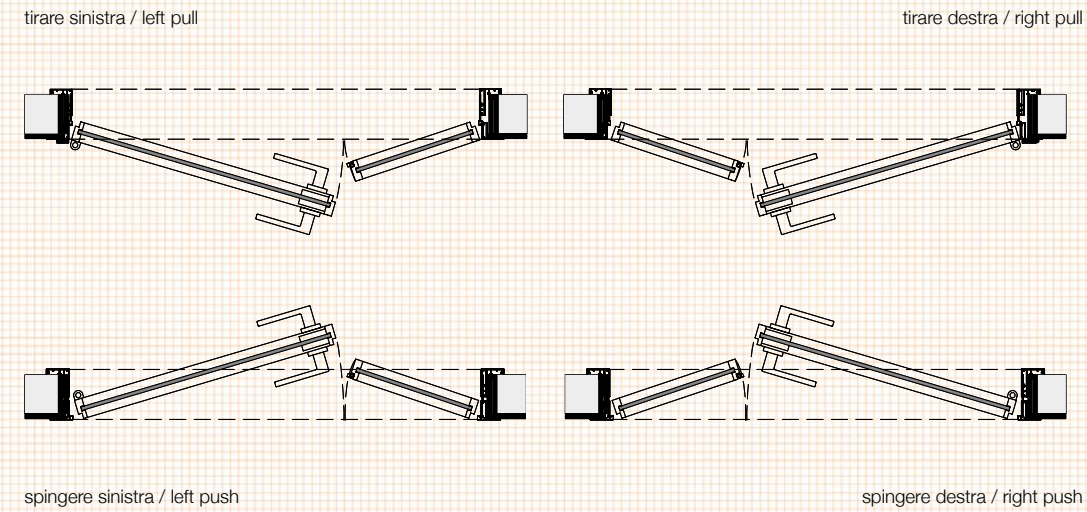

MANIGLIE SHERAZADE SWING FRAME / HANDLES SHERAZADE SWING FRAME

maniglia senza blocco / handle without block
maniglia con cilindro / handle with cylinder lock
maniglia con nottolino A / handle with revolving plug A
maniglia con nottolino B / handle with revolving plug B

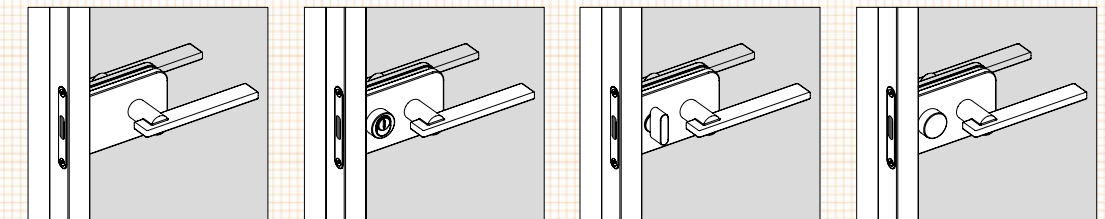

codice / code : LSSBA
codice / code : LSCYA
codice / code : LSCNA
codice / code : LSCNNA

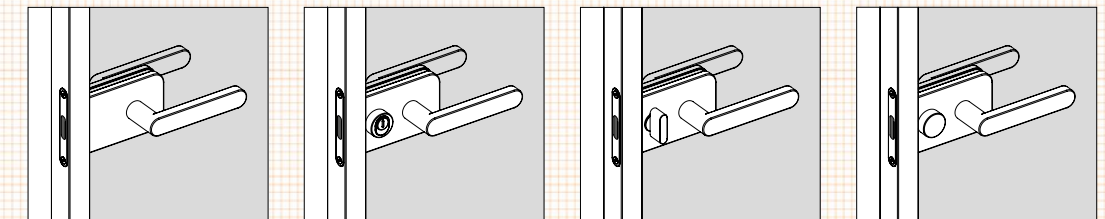

codice / code : LSSBB
codice / code : LSCYB
codice / code : LSCNB
codice / code : LSCNNB

POMOLI SHERAZADE DOUBLE SWING FRAME / KNOBS SHERAZADE DOUBLE SWING FRAME

pomolo senza blocco / knob without block
pomolo con cilindro / knob with cylinder lock
pomolo con nottolino A / knob with revolving plug A
pomolo con nottolino B / knob with revolving plug B

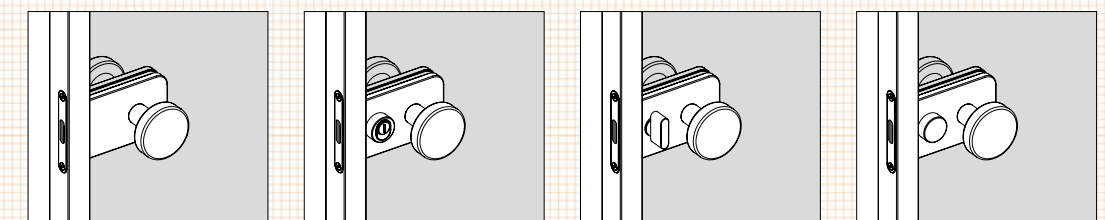

codice / code : PSSB
codice / code : PSCY
codice / code : PSCN
codice / code : PSCNN

Sherazade Swing Frame Patchwork

Design Piero Lissoni

PORTA BATTENTE RASOMURO / SWING DOOR WITH CONCEALED FRAME

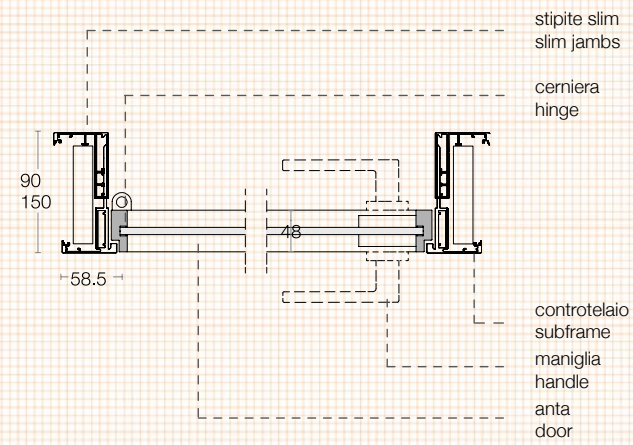
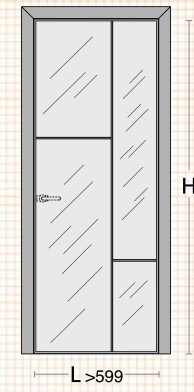

stipite slim
slim jambs
cerniera
hinge
controtelaio
subframe
maniglia
handle
anta
door

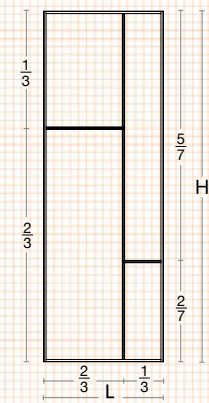

codice / code :
SSWFP01

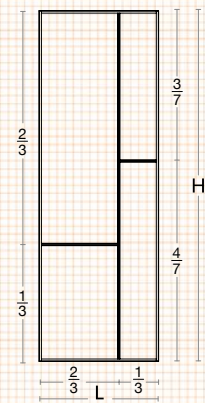

codice / code :
SSWFP02

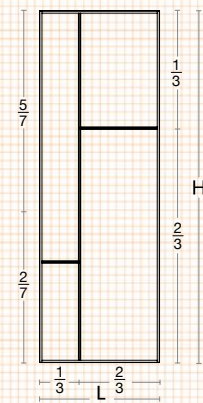

codice / code :
SSWFP03

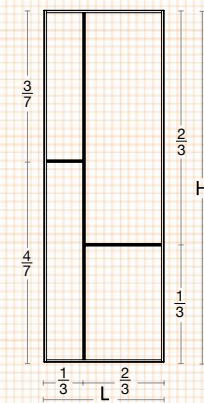

codice / code :
SSWFP04

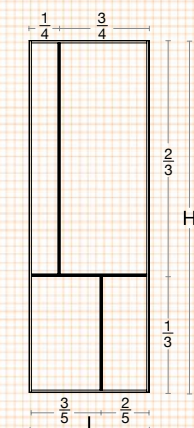

codice / code :
SSWFP05

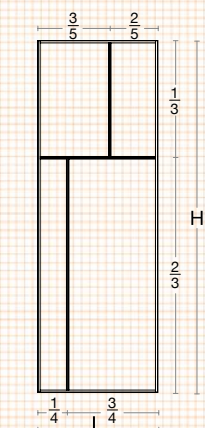

codice / code :
SSWFP06

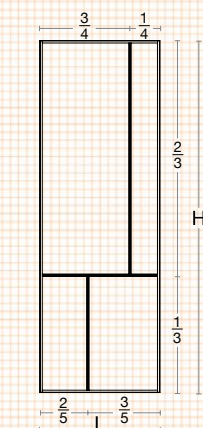

codice / code :
SSWFP07

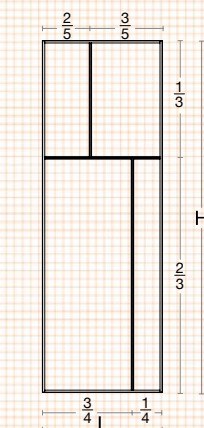

codice / code :
SSWFP08

IPOTESI PROGETTUALI / PROJECT CONFIGURATIONS

tirare sinistra / left pull

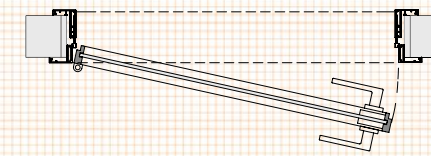

tirare destra / right pull

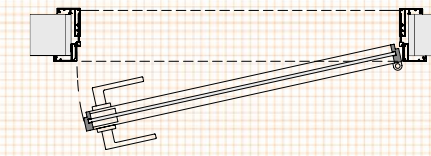

spingere sinistra / left push

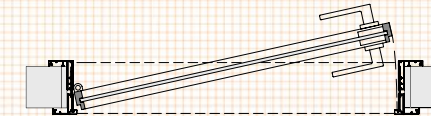

spingere destra / right push



Sherazade Double Swing Frame Patchwork

Design Piero Lissoni

PORTA BATTENTE RASOMURO / SWING DOOR WITH CONCEALED FRAME

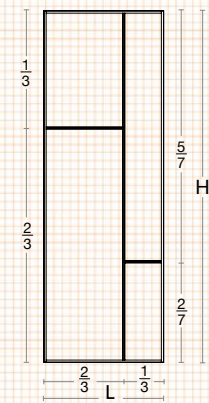
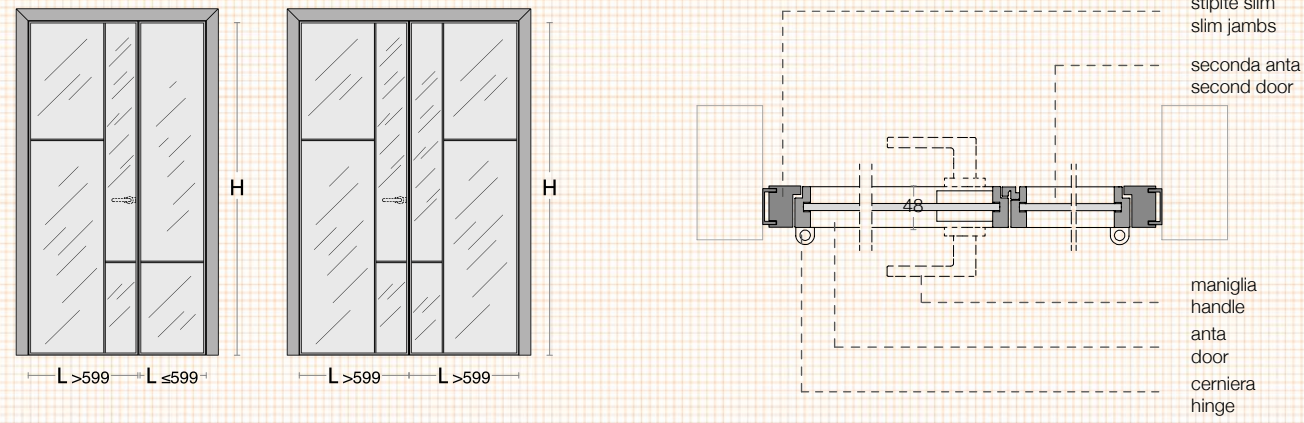

codice / code :
SSWFP01D

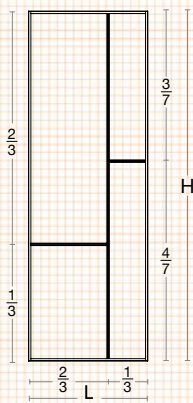

codice / code :
SSWFP02D

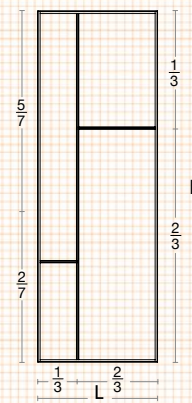

codice / code :
SSWFP03D

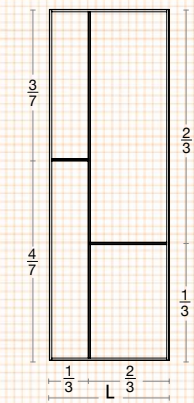

codice / code :
SSWFP04D

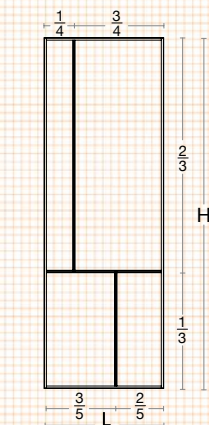

codice / code :
SSWFP05D

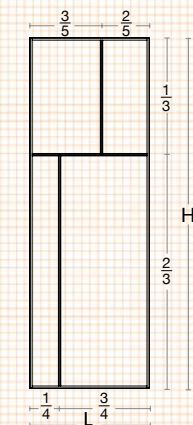

codice / code :
SSWFP06D

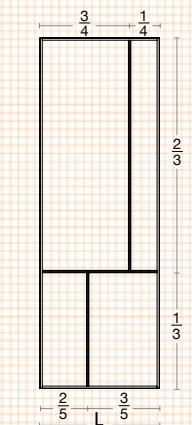

codice / code :
SSWFP07D

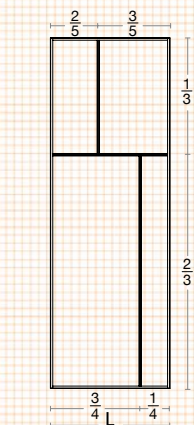

codice / code :
SSWFP08D

CONFIGURAZIONE PORTA / CONFIGURATION DOOR

opzioni seconda
anta L ≤ 599 mm /
second door panel
option L ≤ 599 mm



codice / code :
SSWFP09D



codice / code :
SSWFP10D

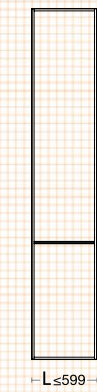

codice / code :
SSWFP11D



codice / code :
SSWFP12D

IPOTESI PROGETTUALI / PROJECT CONFIGURATIONS

tirare sinistra / left pull

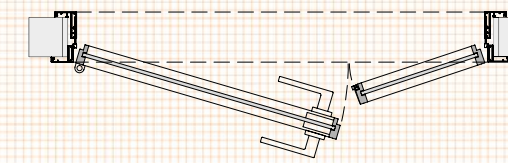

tirare destra / right pull

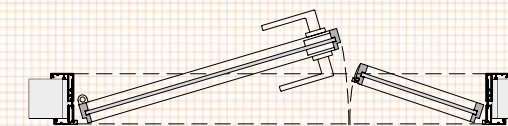
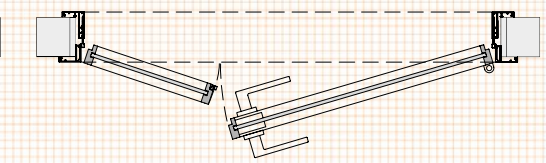

spingere sinistra / left push

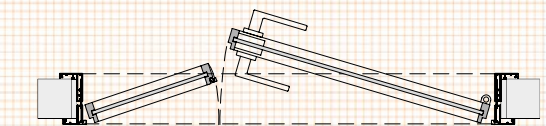

spingere destra / right push



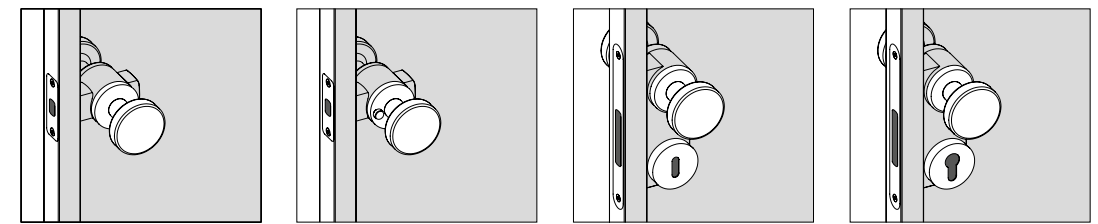
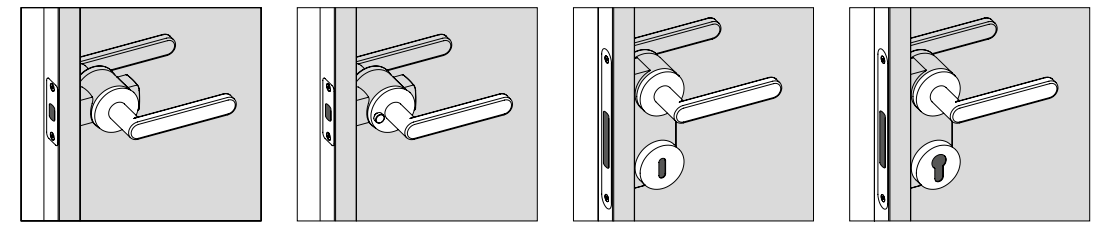
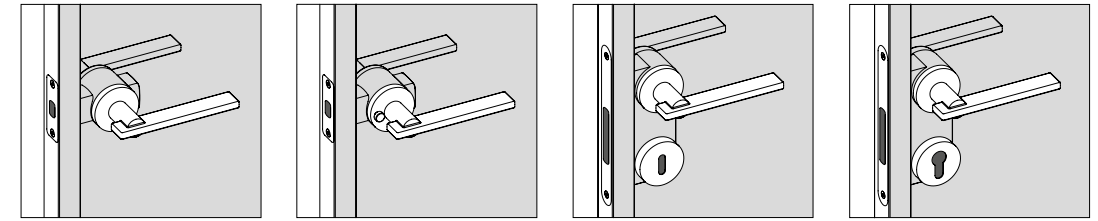

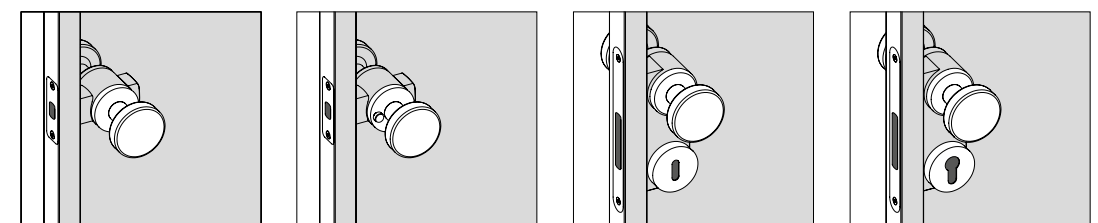
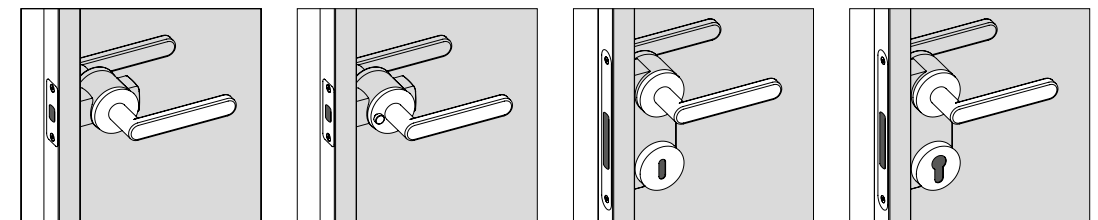
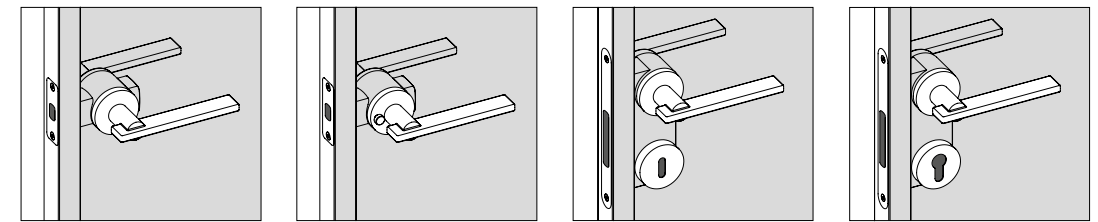



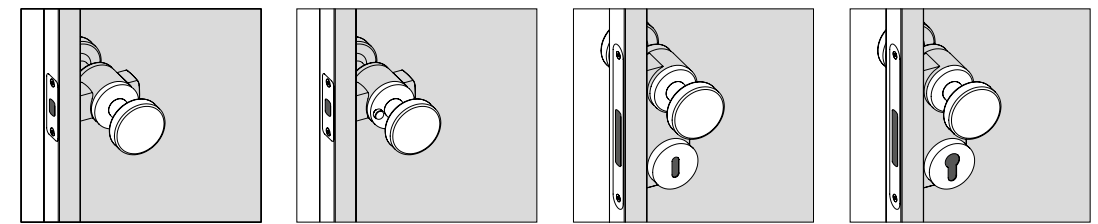
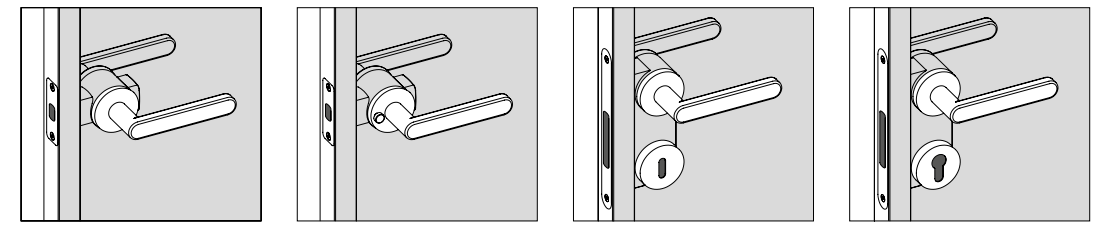
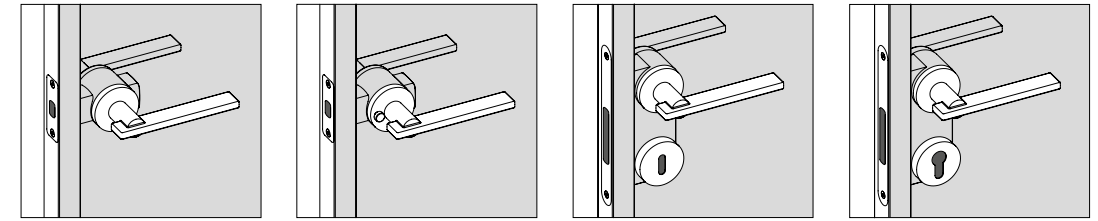

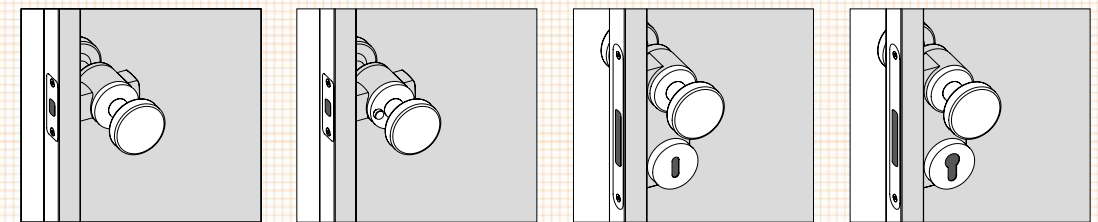
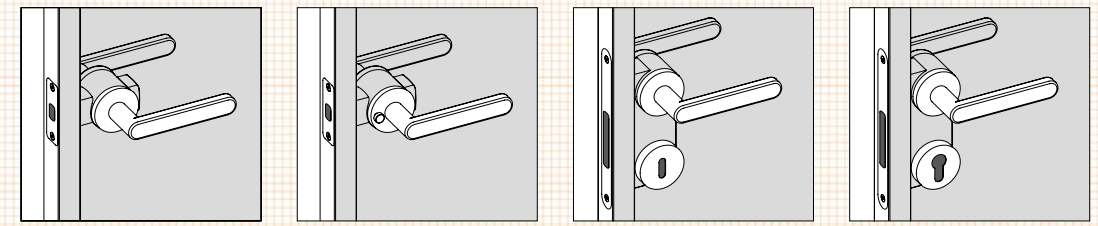
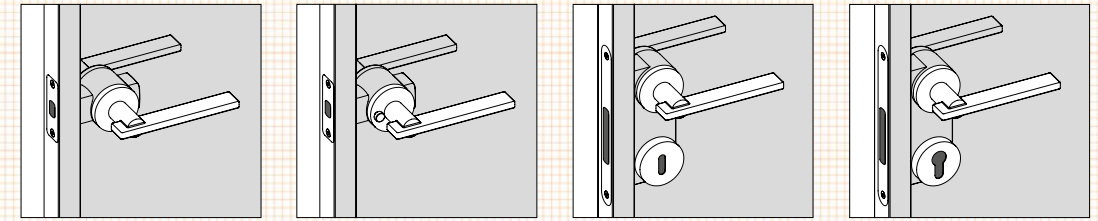
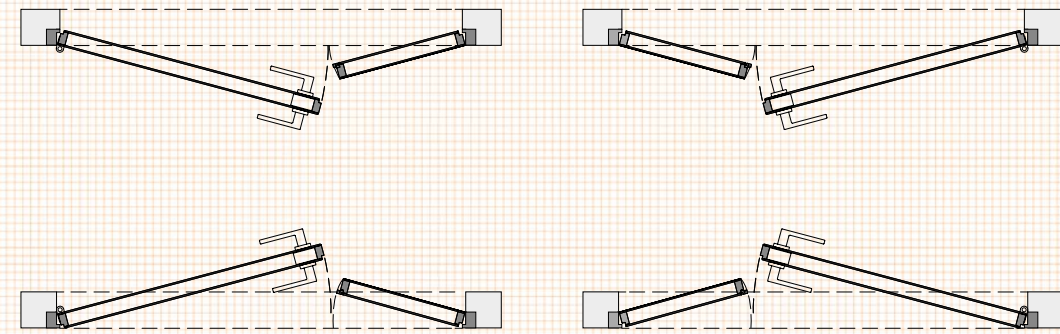
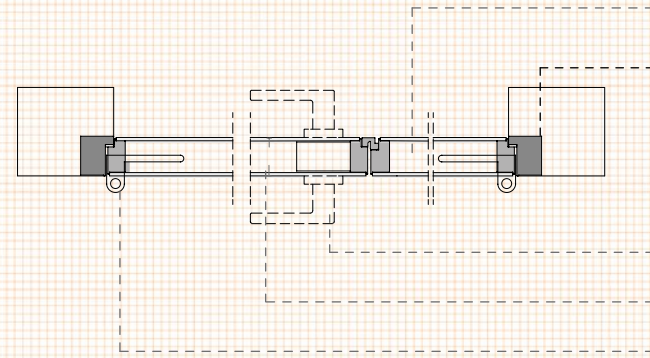



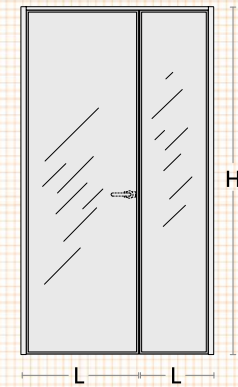

codice
code
ASJM2

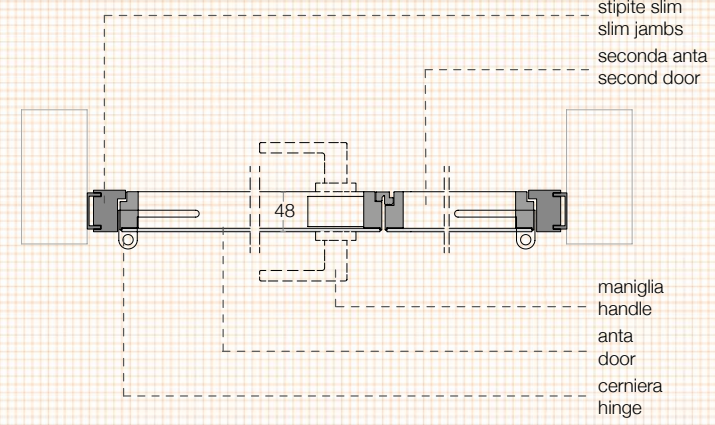

tirare sinistra / left pull

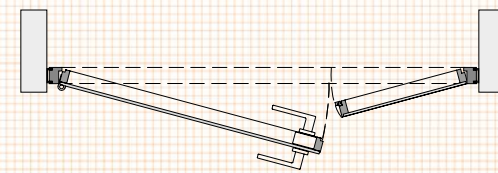

tirare destra / right pull

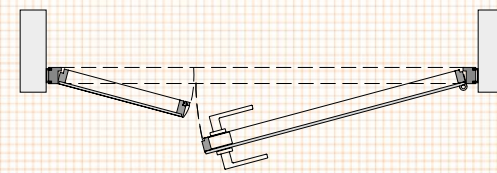

spingere sinistra / left push

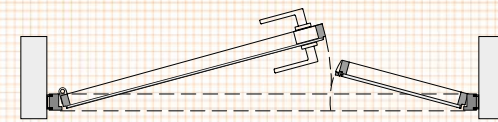

spingere destra / right push

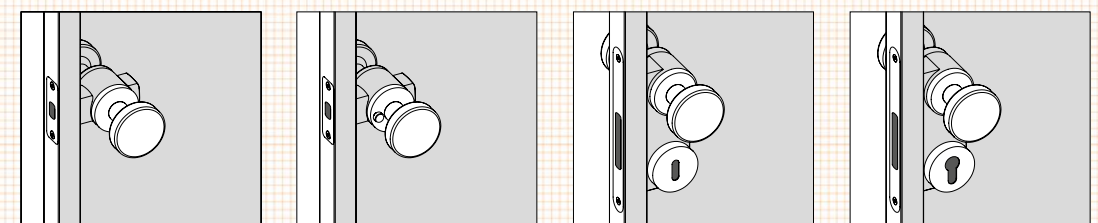
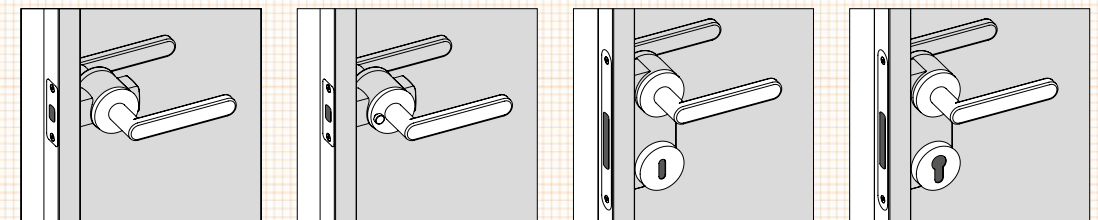
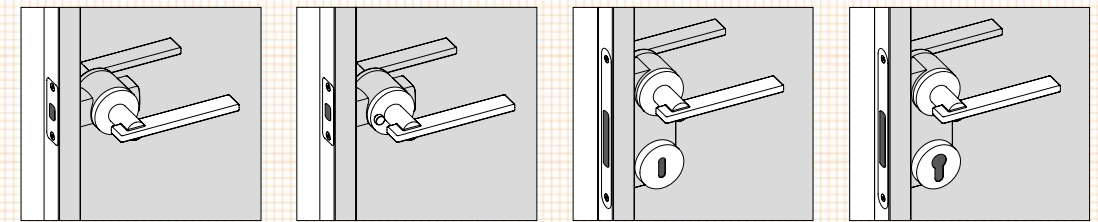
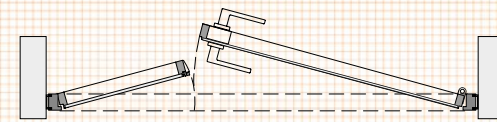



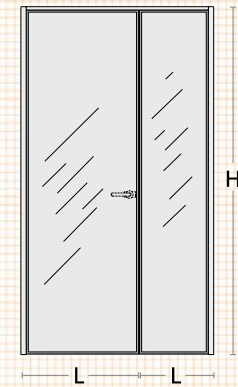

codice
code
ASJD2

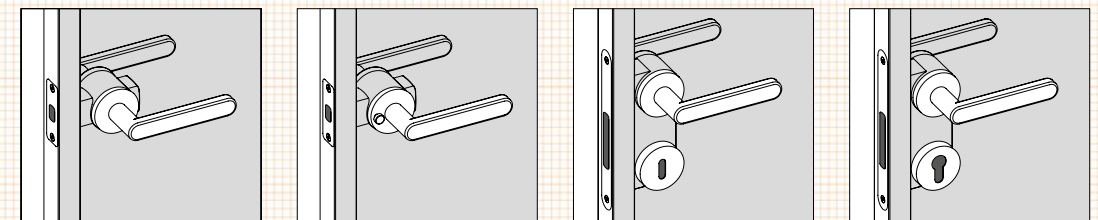
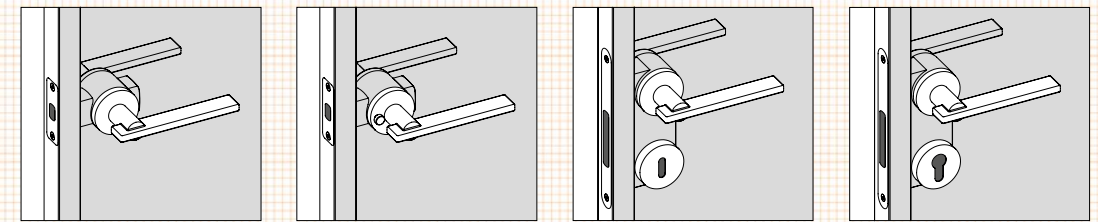
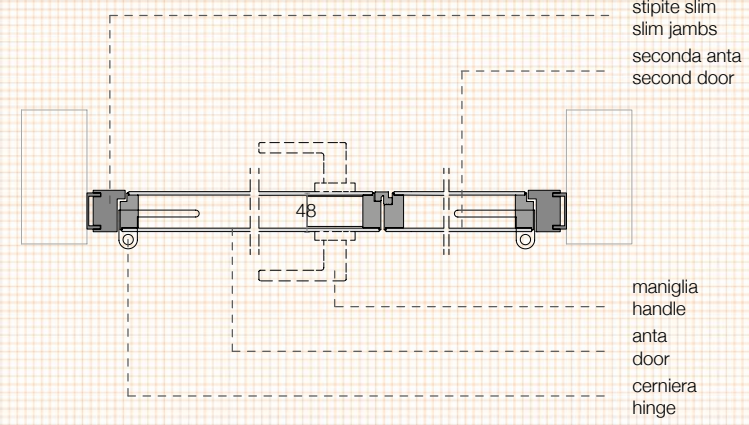

tirare sinistra / left pull

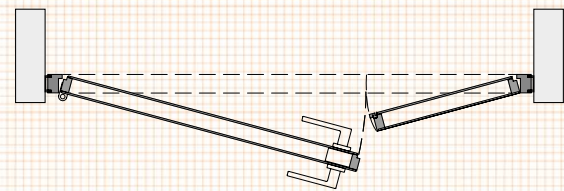

tirare destra / right pull

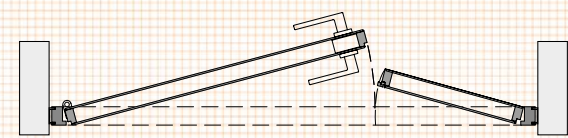
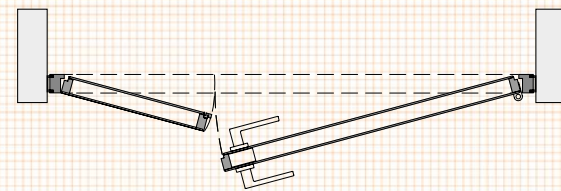

spingere sinistra / left push

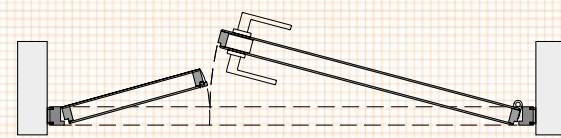

spingere destra / right push

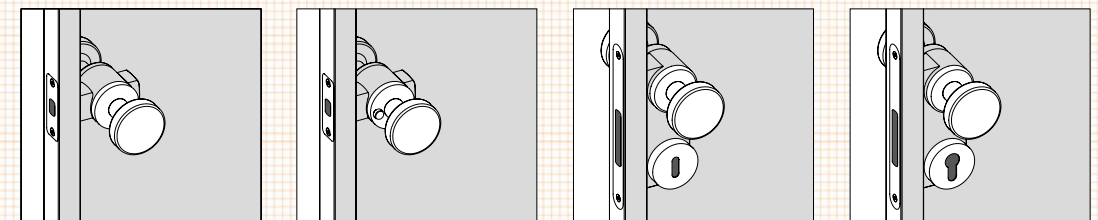



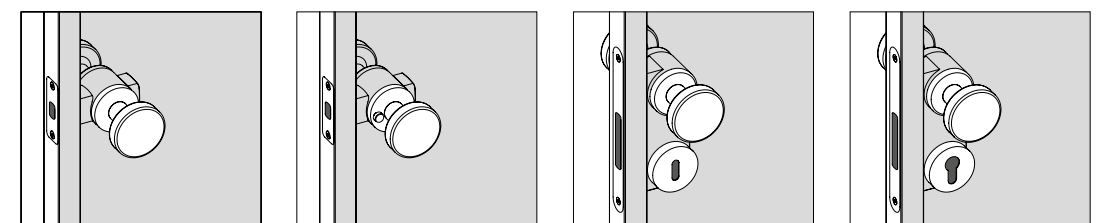
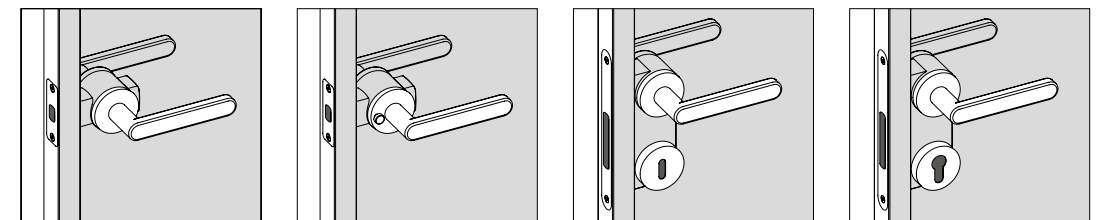
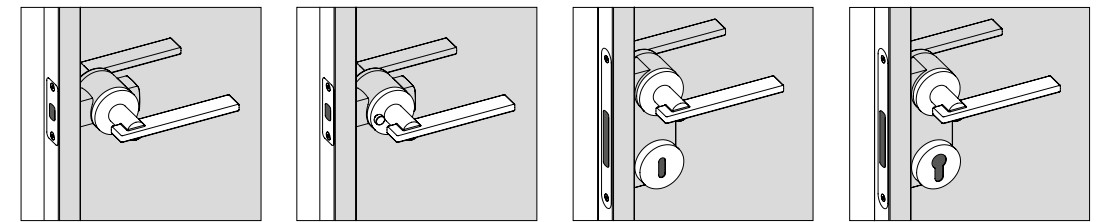

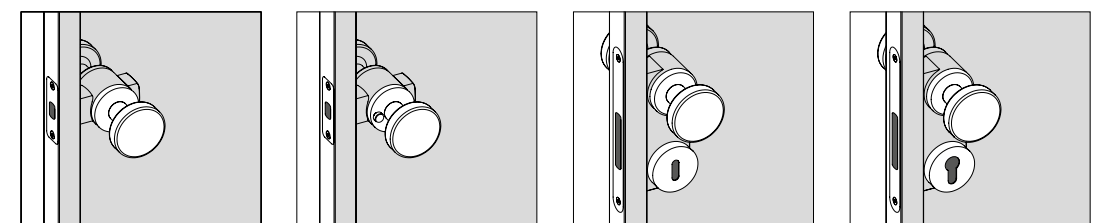
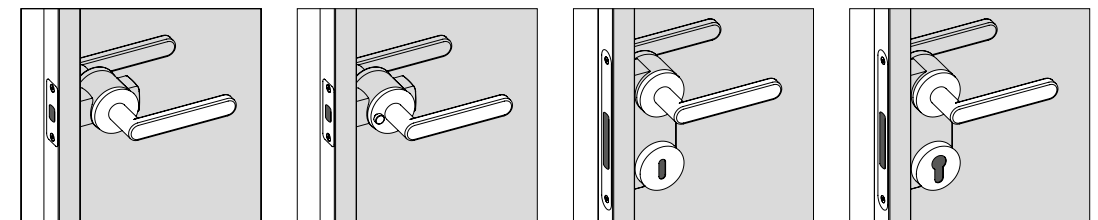
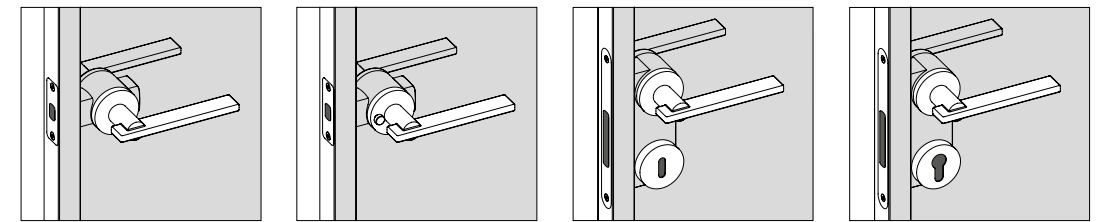

IT

Aladin Swing Frame Duo è una porta singola o doppia a battente prodotta su misura, con stipite telescopico e cerniere a perno regolabili. Dei vetri temperati spessore 4 mm sono applicati su entrambe le facce di un telaio in alluminio, disponibile in cinque finiture, in modo da formare un volume con una camera d'aria interna. I vetri, disponibili in un'ampia gamma di finiture, sono certificati secondo le normative di sicurezza ANSI Z97.1 e UNI EN12150. Sono disponibili anche pannelli in gres o in legno, con diverse finiture ed essenze. E' possibile montare diversi tipi di serratura e scegliere tra maniglia o pomolo che, come lo stipite, sono forniti nella stessa finitura del telaio. Disponibile anche nella versione filo soffitto.



EN

Aladin Swing Frame Duo is a single or double custom made swing door with telescopic jamb and adjustable pivot hinges. Tempered glasses 4 mm thick are applied on both faces of an aluminium frame, available in five different finishes so as to form a volume with an internal air chamber. The glasses are available in a wide range of finishes and they are certified according to the safety regulation ANSI Z97.1 and UNI EN12150. Panels in stoneware and in wood with different finishes and essences are available too. It is possible to assemble different kind of locks and choose between handle and knob which are provided, like the jamb, in the same finishes as the frame. Available also in the version with frame flush with the ceiling.

FR

Aladin Swing Frame Duo est une porte battante simple ou double produite sur mesure, avec un montant télescopique et charnières avec pivot réglables. Des cristaux trempés épaisseur 4 mm sont appliqués sur les deux côtés de un cadre en aluminium, disponible en cinq finitions, de manière à former un volume d'air intérieur. Les verres, disponibles dans une large gamme de finitions, sont certifiés selon les normes de sécurité ANSI Z97.1 et UNI EN12150. Panneaux en grès et bois en différentes finitions et essences sont également disponibles. C'est possible monter différents modèles de serrure et choisir entre poignée ou pommeau que, comme le montant, sont fournis dans la même finition du cadre. Disponible dans la version ras du plafond aussi.

DE

Aladin Swing Frame Duo ist eine Einzel-oder Doppeldrehtür, die nach Maß hergestellt wird und die einen teleskopischen Pfosten und verstellbare Zapfenscharniere hat. Die Glasfüllungen sind je 4 mm stark und gehärtet und sie werden auf die beide Seiten des Aluminiumrahmens angebracht, der in fünf Ausführungen verfügbar ist. Zwischen den Füllungen besteht einen Luftraum. Die Gläser, die in einer Vielzahl von Ausführungen erhältlich sind, sind gemäß ANSI Z97.1 e UNI EN12150 zertifiziert. Feinsteinzeug- und Holzpaneele in verschiedenen Ausführungen und Hölzern sind ebenfalls erhältlich. Man kann verschiedene Arten von Schlössern montieren und man kann zwischen Klinke und Knopf wählen. Die Klinke und der Knopf sind, wie der Pfosten, in derselben Ausführung des Rahmens vorhanden. Verfügbar auch in der Version mit Rahmen bündig mit der Decke.

ES

Aladin Swing Frame Duo es una puerta batiente simple o doble a ras de la pared producida a medida, con jamba telescópica y bisagras de perno regulables. Los cristales templados de 4 mm de espesor están aplicados en ambas caras de un marco de aluminio, disponible en cinco acabados, con el fin de crear un volumen con una cámara de aire interna. Los cristales, disponibles en una amplia gama de acabados, son certificados según las normativas de de seguridad ANSI Z97.1 y UNI EN12150. Estàn disponibles también paneles de gres y madera con diferentes acabados y esencias. Es posible montar diferentes tipos de cerraduras y elegir entre manilla o pomo que, como la jamba, son en el mismo acabado del marco. Disponible también en la versión hilo techo.

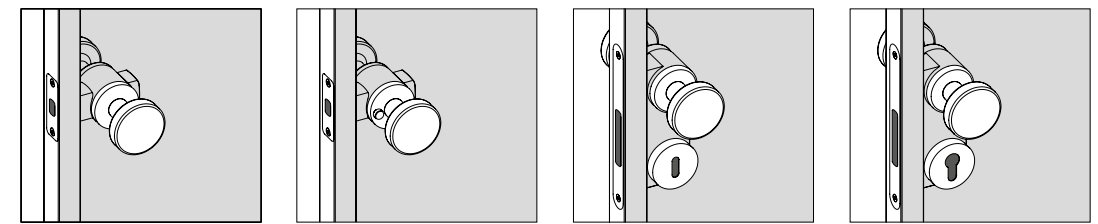
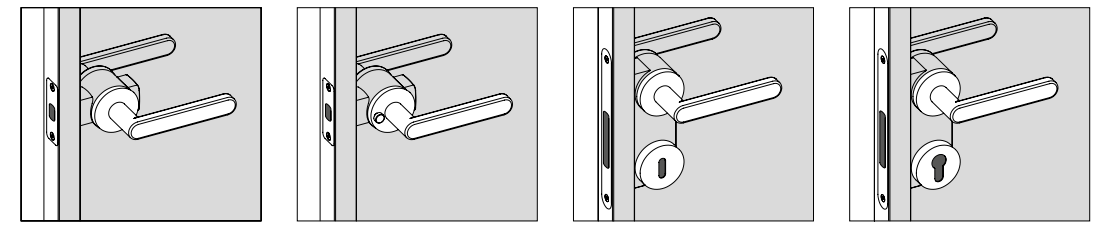
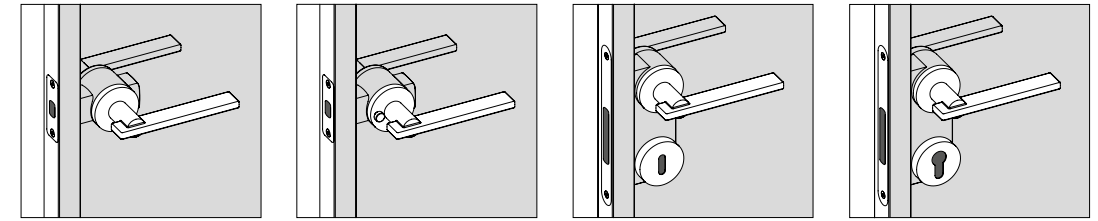

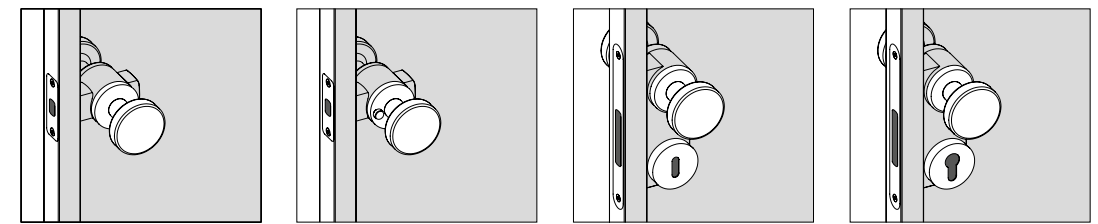
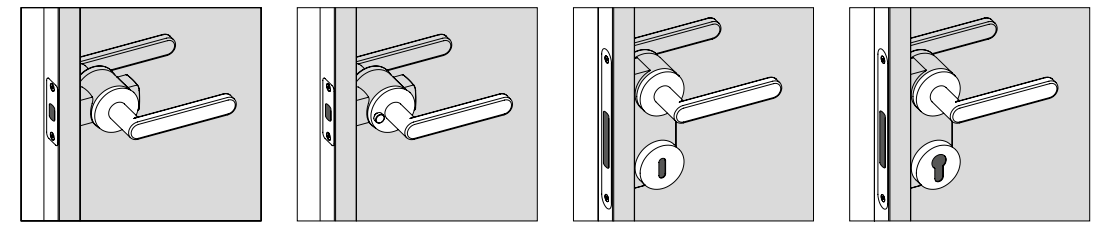
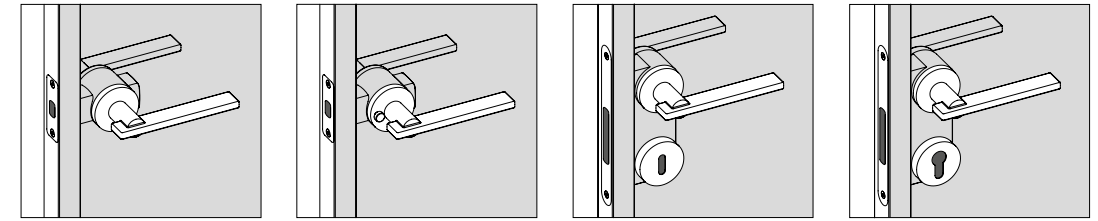

IT

Aladin Pivot Plain Mono è una porta a bilico raso muro prodotta su misura, con cerniere a perno regolabili. Un vetro è applicato su un lato di un telaio in alluminio, disponibile in cinque finiture, in modo da avere una faccia con superficie planare e l'altra con superficie arretrata rispetto alla cornice perimetrale. Il vetro può essere monolitico temperato 6 mm oppure stratificato 3 + 3 mm, disponibile in una vastissima gamma di finiture. Tutti i vetri sono certificati secondo le normative di sicurezza ANSI Z97.1 e UNI EN12150. Sono disponibili anche pannelli in gres con diverse finiture. E' possibile montare diversi tipi di serrature e scegliere tra maniglia o pomolo, nella stessa finitura del telaio. Il controtelaio in alluminio decappato, invisibile quando la porta è chiusa, è disponibile sia per pareti cementizie sia in cartongesso e può essere verniciato direttamente con la pitturazione delle pareti.



EN

Aladin Pivot Plain Mono is a custom-made pivot door with a concealed frame and with adjustable pivot hinge openings. A glass is applied on one side of an aluminium frame, available in five different finishes, so as to have a face with a flush surface, and another surface rebated from the perimeter aluminium frame. The glass can be monolithic tempered 6 mm in a single piece or laminated 3 + 3 mm available in a wide range of different finishes. All glasses are certified according to the safety regulation ANSI Z97.1 and UNI EN12150. Panels in stoneware with different finishes are available too. It is possible to assemble different kind of locks and choose between handle and knob, which are provided in the same finishes as the frame. The pickled aluminium subframe, invisible when the door is closed, is available for both cement walls and plasterboard and can be varnished during the painting of the walls.

FR

Aladin Pivot Plain Mono est une porte pivotante au ras du mur produite sur mesure, avec charnières avec pivot réglables. Un cristal est appliqué sur un côté de un cadre en aluminium, disponible en cinq finitions, de façon à avoir un côté avec surface plane et l'autre côté avec une surface en retrait par rapport au cadre périmétrique en aluminium. Le cristal peut être monolithique trempé 6 mm ou stratifié 3 + 3 mm, disponible dans une large gamme de finitions. Tous les verres sont certifiés selon les normes de sécurité ANSI Z97.1 et UNI EN12150. Panneaux en grès en différentes finitions sont également disponibles. C'est possible monter différents modèles de serrure et choisir entre poignée ou pommeau, dans la même finition du cadre. Le pré-cadre en aluminium décapé, invisible lorsque la porte est fermée, est disponible pour les parois en ciment ou en Placoplatre et peut être verni directement pendant la peinture des murs.

DE

Aladin Pivot Plain Mono ist eine Schwenktür bündig mit der Wand, nach Maß hergestellt und mit verstellbaren Zapfenscharnieren. Der umlaufende Aluminiumrahmen, der in fünf Ausführungen verfügbar ist, ist mit einer einseitigen Glasfüllung versehen, die einseitig bündig mit dem Rahmen abschließt und auf der Gegenseite zurückspringt. Das Glas kann 6 mm stark monolithisch gehärtet oder 3 + 3 mm stark beschichtet sein und es ist in einer sehr weiten Serie von Ausführungen verfügbar. Alle Gläser sind gemäß ANSI Z97.1 und UNI EN 12150 zertifiziert. Feinsteinzeug-Paneele in verschiedenen Ausführungen sind ebenfalls erhältlich. Man kann verschiedene Arten von Schloss montieren und man kann zwischen Klinke oder Knopf, in dieselbe Ausführung des Rahmens, wählen. Der Doppelrahmen aus dekapiertem Aluminium, unsichtbar bei geschlossener Tür, ist sowohl für Betonwände als auch für Gipskartonwände verfügbar. Die Rahmeninstallation muss während der Rohbauphase durchgeführt werden, die Feinbearbeitung direkt beim Wände streichen.

ES

Aladin Pivot Plain Mono es una puerta pivotante a ras de la pared producida a medida, con bisagras de perno regulables. Un cristal está aplicado en un lado de un marco de aluminio, disponible en cinco acabados, con el fin de tener una cara con superficie coplanar y la otra con superficie retraída respecto del marco perimetral de aluminio. El cristal puede ser monolitico templado 6 mm o estratificado 3 + 3 mm, disponibles en una amplia gama de acabados. Todos los cristales son certificados según las normativas de seguridad ANSI Z97.1 y UNI EN12150. Están disponibles también paneles de gres con diferentes acabados. Es posible montar diferentes tipos de cerraduras y elegir entre manilla o pomo, en el mismo acabado del marco. El contra marco en aluminio decapado, invisible cuando la puerta está cerrada, está disponible tanto para paredes de cemento como de pladur y puede ser barnizado directamente con la pintura de las paredes.

codice
code
ABPM

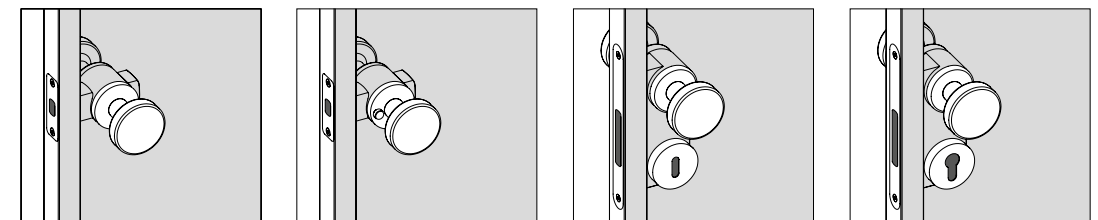
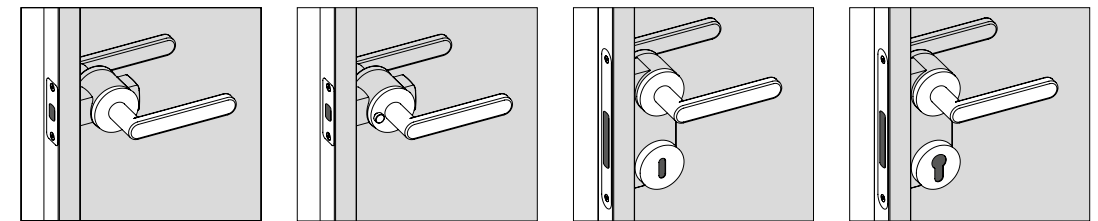
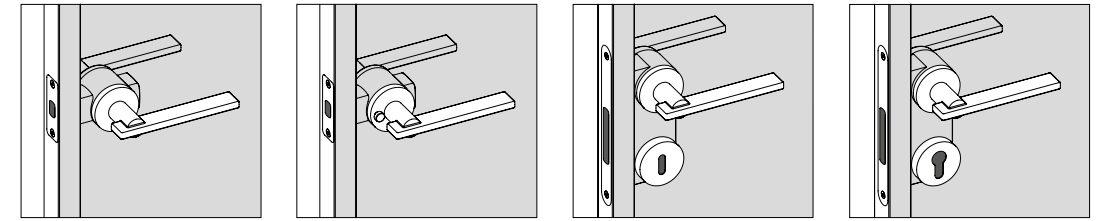
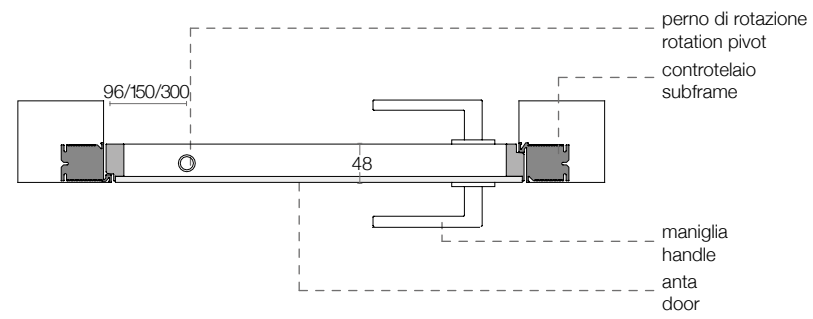
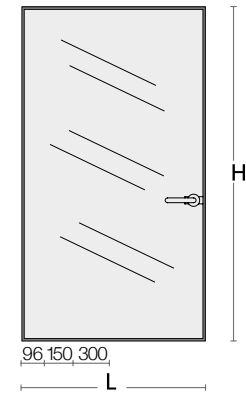

IT

Aladin Pivot Plain Duo è una porta a bilico raso muro prodotta su misura, con cerniere a perno regolabili.

Dei vetri temperati spessore 4 mm sono applicati su entrambe le facce di un telaio in alluminio, disponibile in cinque finiture, in modo da formare un volume con una camera d'aria interna. I vetri, disponibili in un'ampia gamma di finiture, sono certificati secondo le normative di sicurezza ANSI Z97.1 e UNI EN12150. Sono disponibili anche pannelli in gres o in legno, con diverse finiture ed essenze. E' possibile montare diversi tipi di serrature e scegliere tra maniglia o pomolo nella stessa finitura del telaio. Il controtelaio in alluminio decappato, invisibile quando la porta è chiusa, è disponibile sia per pareti cementizie sia in cartongesso e può essere verniciato direttamente con la pitturazione delle pareti.

EN

Aladin Pivot Plain Duo is a custom-made pivot door with a concealed frame and with adjustable pivot hinge openings. The 4 mm thick tempered glasses are applied on both faces of an aluminium frame, available in five different finishes, so as to form a volume with an internal air chamber. The glasses are available in a wide range of finishes and they are certified according to the safety regulation ANSI Z97.1 and UNI EN12150. Panels in stoneware and in wood with different finishes and essences are available too. It is possible to assemble different locks and choose either between handle and knob in the finishes as the frame.

The pickled aluminium subframe, invisible when the door is closed, is available for both cement walls and plasterboard and can be varnished during the painting of the walls.

FR

Aladin Pivot Plain Duo est une porte pivotante au ras du mur produite sur mesure, avec charnières avec pivot réglables. Des cristaux trempés épaisseur 4 mm sont appliqués sur les deux côtés de un cadre en aluminium, disponible en cinq finitions, de manière à former un volume d'air intérieur. Les verres, disponibles dans une large gamme de finitions, sont certifiés selon les normes de sécurité ANSI Z97.1 et UNI EN12150. Panneaux en grès et bois en différentes finitions et essences sont également disponibles. C'est possible monter différents modèles de serrure et choisir entre poignée ou pommeau, dans la même finition du cadre. Le pré-cadre en aluminium décapé, invisible lorsque la porte est fermée, est disponible pour les parois en ciment ou en Placoplatre et peut être verni directement pendant la peinture des murs.



DE

Aladin Pivot Plain Duo ist eine Schwenktür bündig mit der Wand, nach Maß hergestellt und mit verstellbaren Zapfenscharnieren. Die Glasfüllungen sind je 4 mm stark und gehärtet und sie werden auf die Seite des Aluminiumrahmens, der in fünf Ausführungen verfügbar ist, angebracht. Zwischen den Füllungen besteht einen Luftraum. Die Gläser, die in einer Vielzahl von Ausführungen erhältlich sind, sind gemäß ANSI Z97.1 e UNI EN12150 zertifiziert. Feinsteinzeug- und Holzpaneele in verschiedenen Ausführungen und Hölzern sind ebenfalls erhältlich. Man kann verschiedene Arten von Schlössern montieren und man kann zwischen Klinke oder Knopf, in dieselbe Ausführung des Rahmens, wählen. Der Doppelrahmen aus dekapiertem Aluminium, unsichtbar bei geschlossener Tür, ist sowohl für Betonwände als auch für Gipskartonwände verfügbar. Die Rahmeninstallation muss während der Rohbauphase durchgeführt werden, die Feinbearbeitung direkt beim Wände streichen.

ES

Aladin Pivot Plain Duo es una puerta pivotante a ras de la pared producida a medida, con bisagras de perno regulables. Los cristales templados de 4 mm de espesor están aplicados en ambas caras de un marco de aluminio, disponible en cinco acabados, con el fin de crear un volumen con una cámara de aire interna. Los cristales, disponibles en una amplia gama de acabados, son certificados según las normativas de de seguridad ANSI Z97.1 y UNI EN12150. Estàn disponibles también paneles de gres y madera con diferentes acabados y esencias. Es posible montar diferentes tipos de cerraduras y elegir entre manilla o pomolo, en el mismo acabado del marco. El contra marco en aluminio decapado, invisible cuando la puerta está cerrada, está disponible tanto para paredes de cemento como de pladur y puede ser barnizado directamente con la pintura de las paredes.

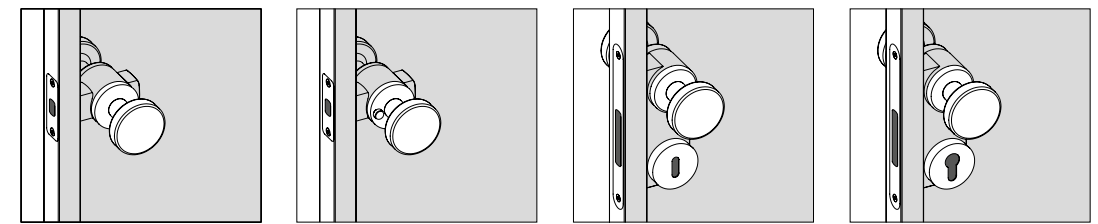
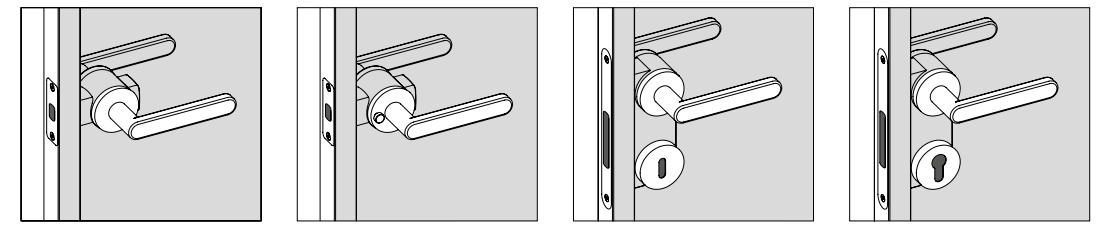
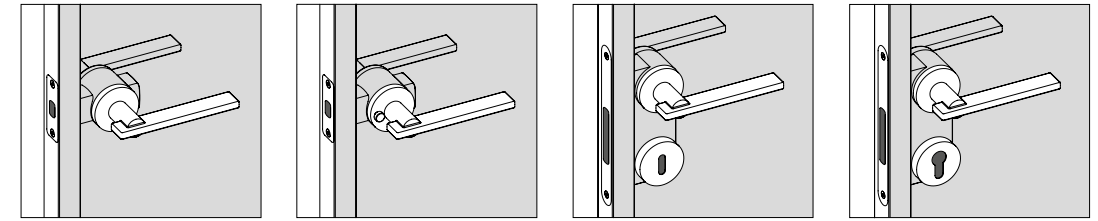

Finiture Telai / Frames Finishes
 Finiture Alluminio / Aluminium Finishes

25 - DISEGNI TECNICI + FINITURE

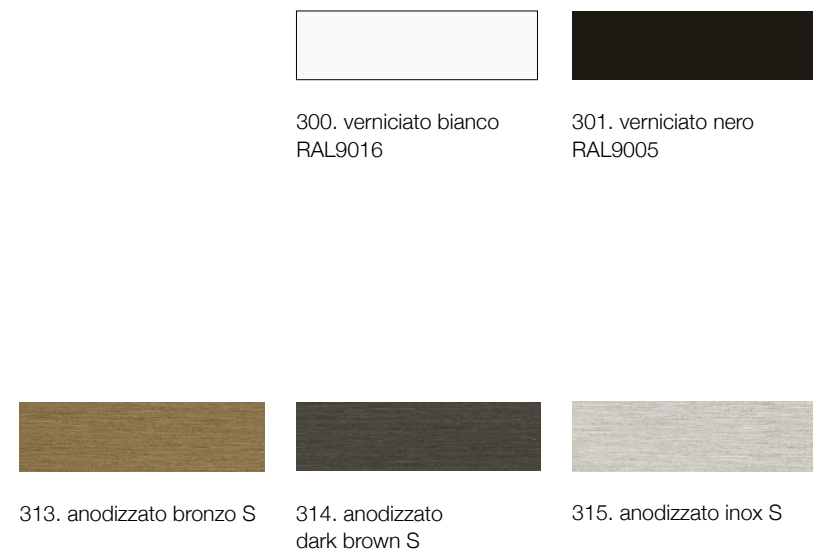

LACCATO OPACO /
MATT LACQUERED

ANODIZZATO /
ANODIZED

Finiture Pannelli / Panels Finishes
 Cristalli trasparenti / Transparent glass

CRISTALLI TRASPARENTI NEUTRI /
NEUTRAL TRANSPARENT GLASS

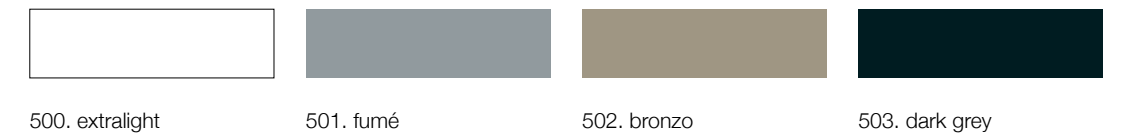

CRISTALLI TRASPARENTI COLORATI /
TRANSPARENT COLOURED GLASS

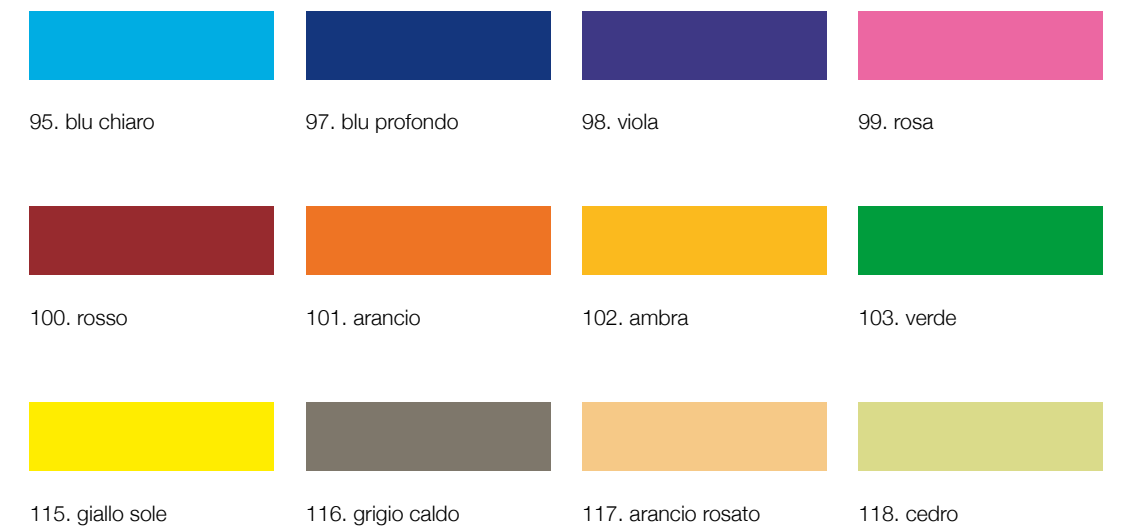

25 - DISEGNI TECNICI + FINITURE

Finiture Pannelli / Panels Finishes
Cristalli Riflettenti / Reflecting Glass



504. riflettente chiaro

505. riflettente fumé

506. riflettente bronzo

CRISTALLI RIFLETTENTI TRASPARENTI /
REFLECTING TRANSPARENT GLASS



508. acidato riflettente
chiaro

509. acidato riflettente
fumé

510. acidato riflettente
bronzo

CRISTALLI RIFLETTENTI ACIDATI /
REFLECTING ACID-ETCHED GLASS



511. specchio argento

SPECCHIO /
MIRROR

Finiture Pannelli / Panels Finishes
Cristalli laccati / Lacquered glass

CRISTALLI LACCATI LUCIDI /
GLOSSY LACQUERED GLASS



35. antracite

36. ferro

37. nocciola

38. cemento



39. panna

40. bianco

41. beige

42. perla



43. tortora

44. grigio

45. caffè

46. nero



47. verde mimetico

48. verde mela

49. giallo

50. arancio



51. rosso fuoco

52. rosso mattone

53. viola

54. blu

Finiture Pannelli / Panels Finishes
Cristalli laccati / Lacquered glass

Finiture Pannelli / Panels Finishes
Cristalli laccati / Lacquered glass

25 - DISEGNI TECNICI + FINITURE



CRISTALLI LACCATI RIFLETTENTI / REFLECTING LACQUERED GLASS

CRISTALLI LACCATI OPACHI / MATT LACQUERED GLASS



25 - DISEGNI TECNICI + FINITURE

Finiture Pannelli / Panels Finishes
Cristalli diffusori / Diffuser glass



125. neve 126. azzurro 127. blu profondo 128. viola



129. rosa 130. rosso 131. arancio 132. ambra



133. verde 135. grigio caldo 136. arancio rosato 137. cedro

CRISTALLI DIFFUSORI COLORATI OPACHI /
 OPAQUE COLOURED DIFFUSER GLASS



155. neve 156. azzurro 157. blu profondo 158. viola



159. rosa 160. rosso 161. arancio 162. ambra



163. verde 165. grigio caldo 166. arancio rosato 167. cedro

CRISTALLI DIFFUSORI COLORATI LUCIDI /
 GLOSSY COLOURED DIFFUSER GLASS

Finiture Pannelli / Panels Finishes
Cristalli diffusori / Diffuser glass

CRISTALLI ACIDATI MONOFACCIALI /
 SINGLE FACED ACID-ETCHED GLASS



600. acidato monofacciale extralight 601. acidato monofacciale fumé 602. acidato monofacciale bronzo

CRISTALLI ACIDATI BIFACCIALI /
 DOUBLE FACED ACID-ETCHED GLASS



603. acidato bifacciale extralight 604. acidato bifacciale fumé 605. acidato bifacciale bronzo

Finiture Pannelli / Panels Finishes
Cristalli stampati / Patterned glass

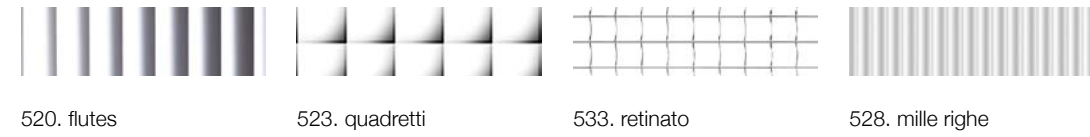

520. flutes 523. quadretti 533. retinato 528. mille righe

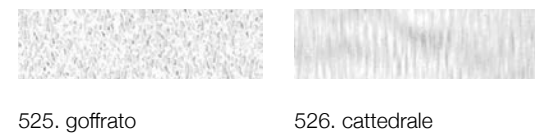

525. gofrato 526. cattedrale

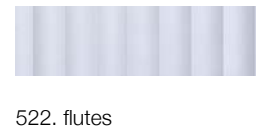

522. flutes

CRISTALLI STAMPATI TRASPARENTI /
 TRANSPARENT PATTERNED GLASS

CRISTALLI FLUTES TRASPARENTI COLORATI /
 FLUTES TRANSPARENT COLOURED GLASS

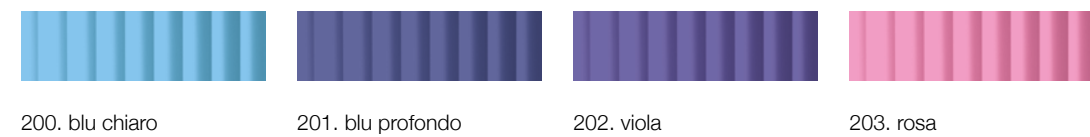

200. blu chiaro 201. blu profondo 202. viola 203. rosa

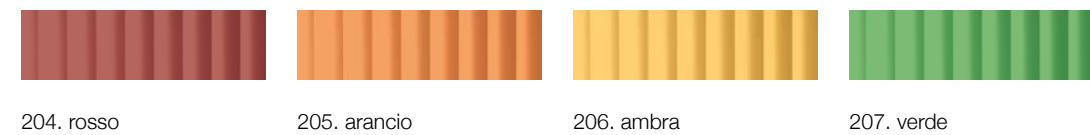

204. rosso 205. arancio 206. ambra 207. verde

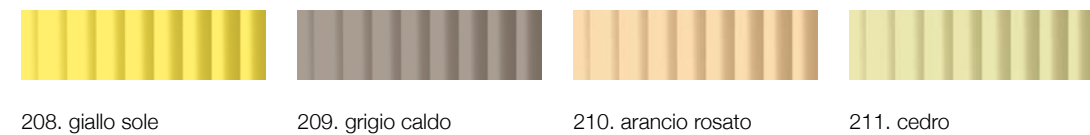

208. giallo sole 209. grigio caldo 210. arancio rosato 211. cedro

Cristalli con reti / Glass with meshes

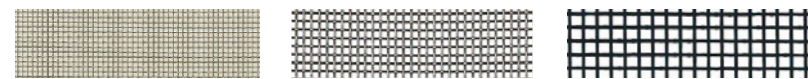

531. wide bronze 534. wide steel 535. dark grid

CRISTALLO EXTRALIGHT CON RETI /
 EXTRALIGHT GLASS WITH MESHES

Finiture Pannelli / Panels Finishes
Cristalli con tessuti / Glass with fabrics

CRISTALLO EXTRALIGHT CON TESSUTI /
 EXTRALIGHT GLASS WITH FABRICS



550. giotto 551. raffaello 552. masaccio 553. botticelli



554. carta di riso lucida 555. carta di riso opaca

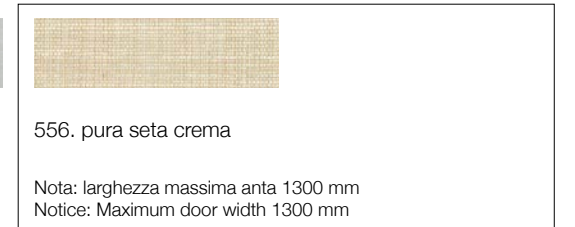

556. pura seta crema

Nota: larghezza massima anta 1300 mm
 Notice: Maximum door width 1300 mm

CRISTALLI STAMPATI ACIDATI /
 ACID-ETCHED PATTERNED GLASS

Cristalli decorati "Pattern" / "Pattern" decorated glass

CRISTALLO EXTRALIGHT SFUMATO /
 SHADED EXTRALIGHT GLASS

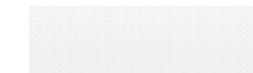

620. bianco

Nota: larghezza massima anta 1300 mm
 Notice: Maximum door width 1300 mm

CRISTALLO RIFLETTENTE SFUMATO /
 SHADED REFLECTING GLASS

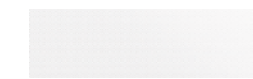

622. bianco

Solo "Aladin Duo", no "Aladin Mono" e "Sherazade" /
 Only for "Aladin Duo" version, not available
 for "Aladin Mono" and "Sherazade" version.

Nota: larghezza massima anta 1300 mm
 Notice: Maximum door width 1300 mm

Finiture Pannelli / Panels Finishes

Cristalli decorati "Life" / "Life" decorated glass

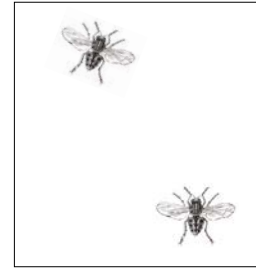

630. mosche

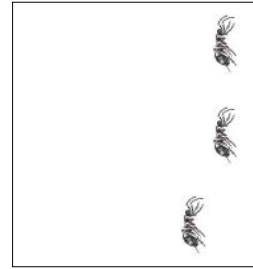

631. formiche



632. farfalle

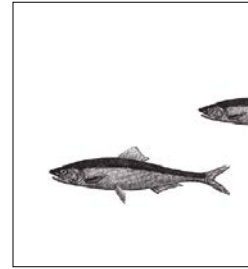

633. pesci

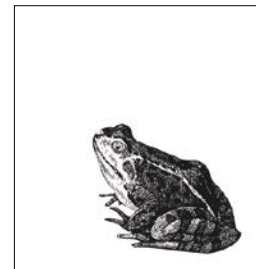

634. rana



635. fiore A



637. fiore B



636. ramo

CRISTALLI DECORATI "LIFE" /
"LIFE" DECORATED GLASS

Finiture Pannelli / Panels Finishes

LEGNI /
WOODS



700. rovere
fiammato bianco



701. rovere
fiammato sabbia



702. rovere
fiammato tabacco



703. rovere
fiammato nero



704. ebano rigato

Nota: larghezza massima anta 1300 mm, altezza massima anta 2800 mm

Notice: maximum door width 1300 mm, maximum door height 2800 mm

GRES /
STONEWARE



800. pietra grigio chiara



801. pietra grigio medio



802. pietra antracite



807. marmo atlas marrone

Nota: larghezza massima anta 1000 mm

Notice: maximum door width 1000 mm

GLAS ITALIA

*Via Cavour 29, 20846
Macherio (MB) - ITALY*

*glas@glasitalia.com
glasitalia.com*

CREDITS

*Progetto grafico:
Le Dictateur Studio*

*Fotografia:
Paola Pansini
Tommaso Sartori
Mimo Visconti*

*Set design:
Cameranesi Pompili
Elisa Ossino*

*Stampato da:
O.G.M. SpA*

*Grazie a:
Acerbis
Amini
Antonio Lupi
Artemide
Astep
Bloc Studios
Cassina
cc-tapis
Domenico Orefice
Driade
Flou
FontanaArte*

*Golran
Illulian
Karpeta
Kerakoll
Knoll
Laminam
Living Divani
Nemo Lighting
Pulpo
SEM Milano
Stefano Pugliese
VCS
Vitra*

